



Made for ideas.

## LACIE 2BIG NAS | LACIE 5BIG NAS PRO USER MANUAL



[CLICK HERE TO ACCESS AN UP-TO-DATE ONLINE VERSION](#)

of this document. You will find the most recent content as well as expandable illustrations, easier navigation, and search capability.

LaCie 2big NAS



LaCie 5big NAS Pro



# INTRODUCTION

This manual covers:

Products	Operating System Version
<a href="#">LaCie 2big NAS</a>	LaCie NAS OS 3 (learn more <a href="#">here</a> )
<a href="#">LaCie 5big NAS Pro</a>	LaCie NAS OS 3

Congratulations on your purchase of a LaCie professional NAS (network-attached storage device). Designed to satisfy the data sharing and backup needs of small, medium, and branch offices, your product belongs to a new generation of NAS.

This manual will guide you through the process of connecting the LaCie NAS to your network and will assist you in troubleshooting any issues that might arise. If you encounter problems, check [Getting Help](#). Note that most of the problems users encounter can be resolved by resetting the product to factory conditions (see [2big NAS Reset](#) or [5big NAS Pro Recovery](#)).

## BOX CONTENT

	LaCie 2big NAS	LaCie 5big NAS Pro
<b>Product</b>	✓	✓
<b>Ethernet cable</b>	✓	✓
<b>External Power supply</b>	✓	✓
<b>Utilities CD-ROM with software</b>	✓	✓
<b>Drive stand for upright use</b>	✓	--
<b>Disk drawer key</b>	✓	✓
<b>USB Key for install and recovery</b>	--	✓
<b>Cable management clip</b>	--	✓

**Important info:** Please save your packaging. In the event that the drive should need to be repaired or serviced, it must be returned in its original packaging.

## MINIMUM SYSTEM REQUIREMENTS

- Latest version of Windows® XP, Windows Vista®, Windows 7, Windows 8 / Mac® OS X 10.5 or higher
- Web browsers: Internet Explorer™ 7.0 or higher, Firefox™ 3.0 or higher, Safari™ 3.0 or higher, or Chrome 2.0 or higher
- Computer with an Ethernet network adapter
- Ethernet switch or router 10/100/1000 (Mb/s)

### **Important info:**

Your LaCie product's performance can be affected by such external forces as network activity, hardware, distance, and setup.

For optimal performance, use a Gigabit Ethernet router and a Gigabit Ethernet board in your host computer.

# VIEWS OF THE PRODUCT

## FRONT VIEW

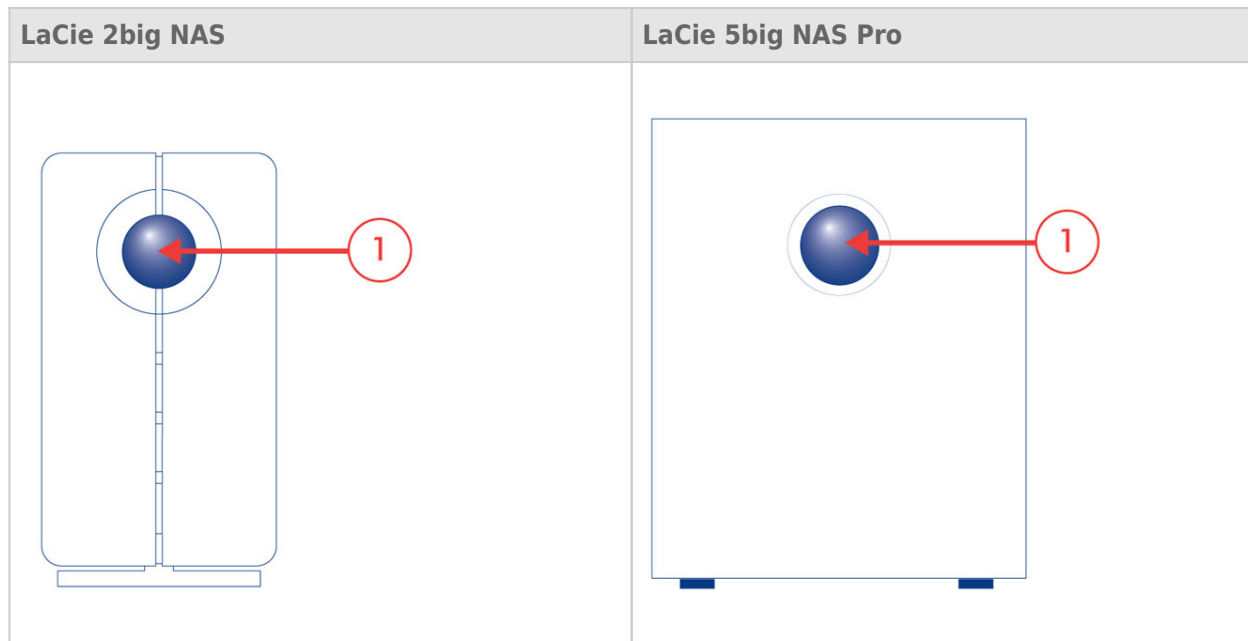

1. **Front LED button:** The LED button signals the status and health of the device. For further details, see [LED Behavior and Button Functions](#).



## REAR VIEW

### LaCie 2big NAS

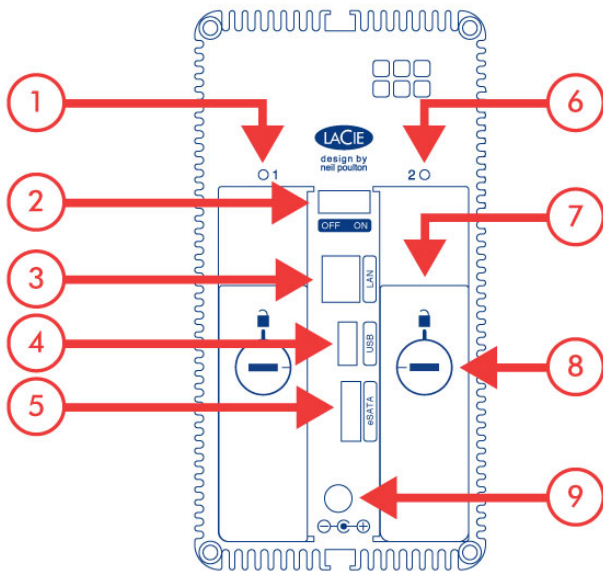

1. Left drive status LED (see [LED Behavior and Button Functions](#))
2. ON/OFF
3. Gigabit Ethernet
4. USB 2.0 expansion
5. eSATA expansion
6. Right drive status LED (see [LED Behavior and Button Functions](#))
7. Drive tray handle
8. Drive lock
9. Power connector

## LaCie 5big NAS Pro

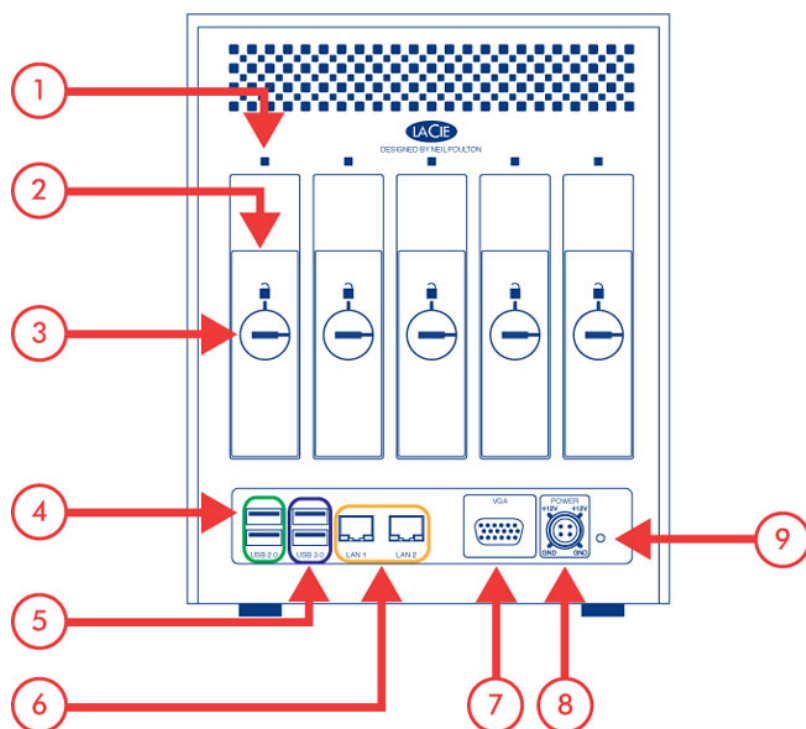

1. Drive status LED (see [LED Behavior and Button Functions](#))
2. Drive tray handle
3. Drive lock
4. USB 2.0 expansion (x2)
5. USB 3.0 expansion (x2)
6. Gigabit Ethernet (x2)
7. VGA port (for maintenance)
8. Power connector
9. Reset button (see [LaCie NAS Rescue: 5big NAS Pro](#))

# LED BEHAVIOR AND BUTTON FUNCTIONS



## GENERAL LED BEHAVIOR

The list of colors below will help you identify the general status of your NAS:

Color	State
Solid blue	Ready
Blinking blue	Startup; shutdown; activity
Blinking red and blue	RAID synchronization; software update
Blinking red	Warning
Solid red	Error

## FRONT AND DISK LEDS

The front and rear LEDs indicate drive status and activity. This section describes the behavior of the LED indicators. Note that even if you have turned off the front LED using **Dashboard > Eco Management**, events triggering a red light will always cause the front LED to turn on.

Front LED Color	Rear LED Color	State
Blinking blue 	Activity LED for working disk(s) (until they are fully initialized) 	Occurs as the device is booting; will cease once the drives are fully initialized
Solid blue 	Activity LED for working disk(s) 	Device is functioning properly and the drives are working (read/write)
Blinking blue/red 	Blinking blue/red 	RAID synchronizing; will cease once operation has concluded
	Activity LED for working disk(s) 	Operating system update in progress
Blinking red 	Solid red for non-functional disk(s) 	RAID is degraded; data is intact but the array is no longer protected should another disk fail
	Activity LED for all disks 	Temperature alert
		Fan is not spinning
Solid red 	Activity LED for working disk(s) 	The NAS is receiving its power via a connected UPS
		Temperature alert (critical level) – the product will shut off
	Solid red for non-functional disk(s) 	Power supply has been cut and the UPS has run out of reserve power – the product will shut off
		RAID has failed and data has been lost
Off in disconnected disk(s)	Off in disconnected disk(s)	Disk(s) is/are disconnected

## FRONT BUTTON

### Short push

**5big NAS Pro only:** When the the product is operating, a short push of the on/off button will turn the 5big NAS Pro off or, place the 5big NAS Pro into deep sleep mode if the option has been configured in NAS OS. See [Eco Management](#) for details on deep sleep mode.

### Long push

**5big NAS Pro only:** A long push of more than four seconds will cut the power from the 5big NAS Pro, forcing it to shut down immediately. A long push is not recommended as it may result in data loss.

### Factory settings/rescue

**LaCie 2big NAS:** The front LED button can be used in tandem with the ON/OFF switch to revert the device to its factory settings (see [Reset to Factory Conditions: 2big NAS](#)).

**LaCie 5big NAS Pro:** The front LED button can be used in tandem with the reset button on the rear of the device to launch the LaCie NAS Rescue (see [LaCie NAS Rescue: 5big NAS Pro](#)).

# HARD DISK HEAT MANAGEMENT

## HEAT DISSIPATION DESIGN - 2BIG NAS

The LaCie 2big NAS Pro's metal body is ideal for naturally dissipating internal drive heat. Its unique design draws heat away from the internal drive toward the external casing. The large surface area of the heat sink casing absorbs internal heat and dissipates it, keeping the drive safe and prolonging its life and reliability.

**As a consequence, it is normal that the external casing is warm to the touch.** Make sure that the vent on the back bezel is not obstructed and that there is a natural airflow across the casing.



## Upright, stack & rackmount configuration

Heat dissipation is maximized when this LaCie product is in the upright position. When stacking the LaCie 2big NAS, you must attach rubber feet (if included) on the under side of your drives. This will allow for airflow between the enclosures so that the heat dissipation can work effectively. LaCie does not recommend stacking or racking more than two LaCie 2big NAS enclosures on top of each other.

## DUAL COOLING - 5BIG NAS PRO

With its dual cooling design, the LaCie 5big NAS Pro's is built to protect against overheating. The 5big's solid aluminum casing diverts and dissipates heat, keeping the drives cooler even after extended periods of activity. Within the casing, a whisper-quiet, thermo-regulated Noctua® fan automatically adapts its speed to the internal temperature. As a result, the fan cools the components, which is vital for long-term use.

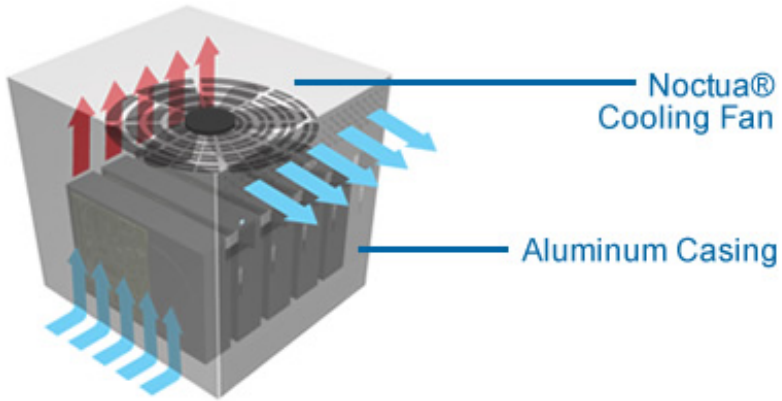

# CONNECT TO THE NETWORK

Connect your LaCie NAS to a network.

**Enclosure without disks:** If you purchased an enclosure that did not include disks, go to [Connect to the Network: Diskless LaCie 2big NAS](#) or [Connect to the Network: Diskless LaCie 5big NAS Pro](#) for instructions on how to connect to your device to the network.

Step 1: Connect the Ethernet cable and power supply

1. Connect the Ethernet cable to the Ethernet port on the back of the product and to an available Ethernet port on your router. Refer to your router's documentation if necessary.
2. Connect the power supply to a wall outlet and to the product.

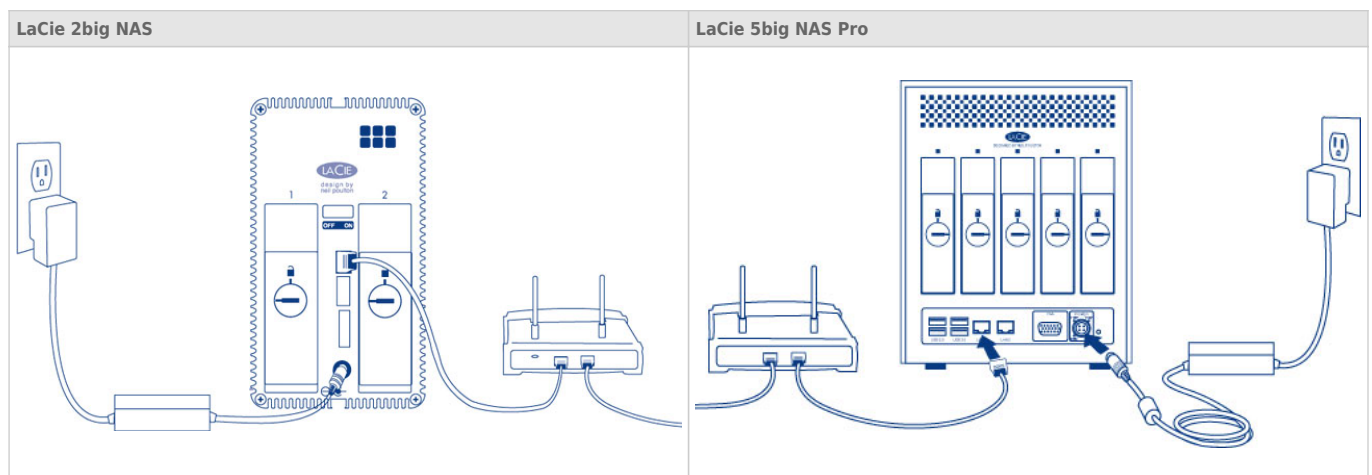



## Step 2: Power on the LaCie NAS

1. Power on the device.
  - LaCie 2big NAS: Push the power button on the back of the device to the **ON** position.
  - LaCie 5big NAS Pro: Lightly push the the front LED button.
2. The front LED will turn on and then begin blinking. The device is ready to be accessed once the LED has turned solid blue. Your LaCie NAS may take up to three minutes to boot.

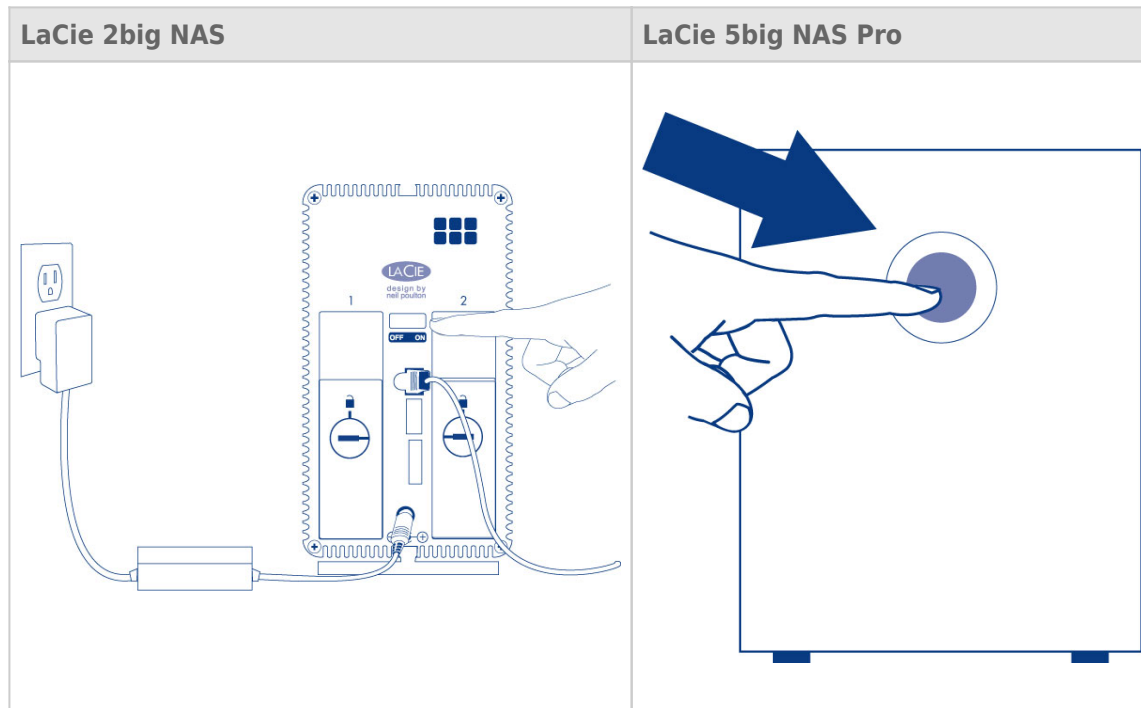

**Caution:** Only use the AC adapter supplied with your specific LaCie device. Do not use a power supply from another LaCie device or another manufacturer. Using any other power cable or power supply may cause damage to the device and void your warranty. Always remove the AC adapter before transporting your LaCie device. Failure to remove the adapter may result in damage and will void your warranty.

Step 3: Access the LaCie NAS Dashboard

**Note:** The steps below should be completed by the administrator of the device.

Perform the steps below on a PC/Mac connected to the same network as your LaCie NAS:

1. Launch your preferred internet browser and type the default address for the LaCie NAS:
  - *Windows workstations (no Bonjour)* - <http://lacie-2big-nas> or <http://lacie-5big-pro>
  - *Mac OS X and Windows workstations running Bonjour* - <http://lacie-2big-nas.local> or <http://lacie-5big-pro.local>.

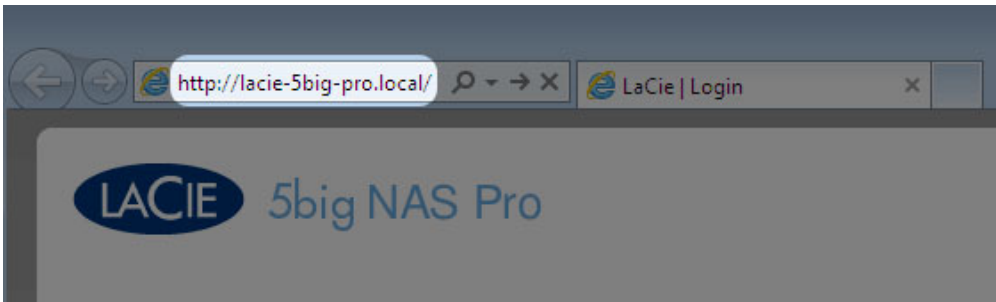

2. The Dashboard administration tool will prompt you to create an administrator password.

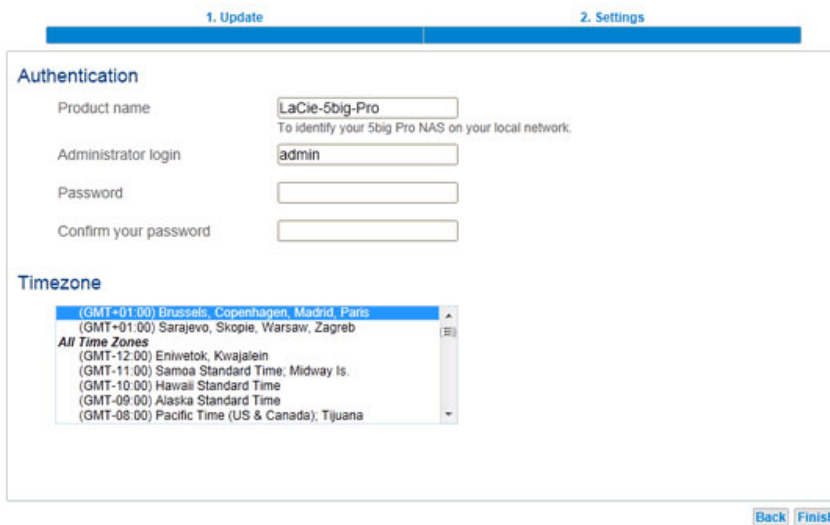

3. You may also change:
  - The name of the device (the defaults are *LaCie-2big-NAS* or *LaCie-5big-Pro*).
  - The administrator login (the default is *admin*).
  - The time zone.
4. Make certain to note your login and password for future use.
5. Choose **Finish**. You will be taken to the Dashboard home page.

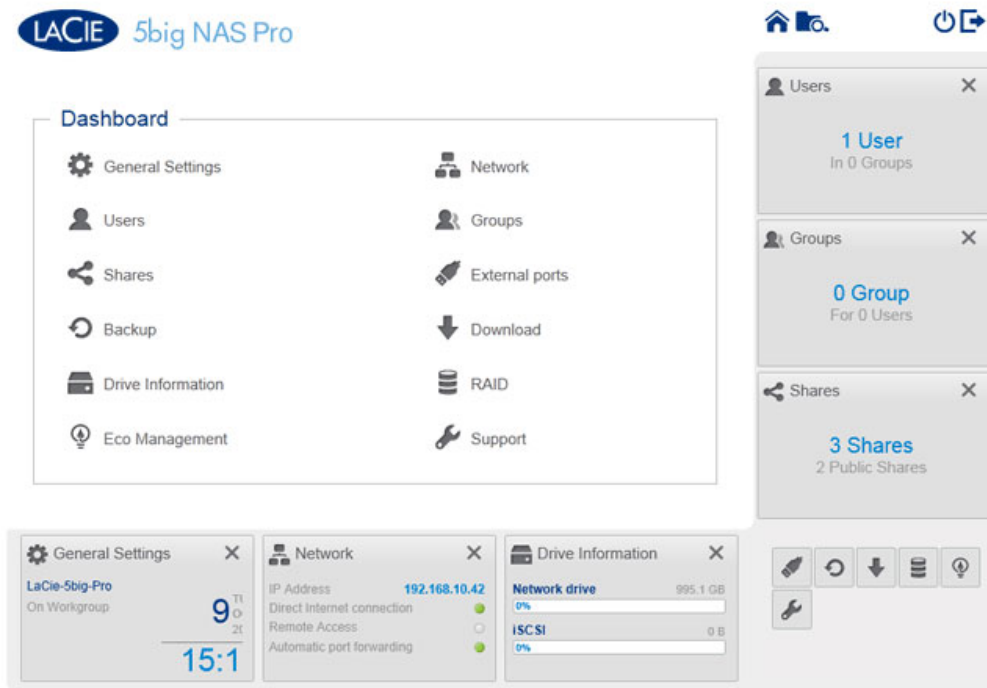

## NEXT STEPS

- **Simplify NAS access:** LaCie recommends that you install the software utility *LaCie Network Assistant* before moving forward with the device configuration. LaCie Network Assistant gives you instant information on your LaCie NAS, such as firmware version, IP address, and hardware address. It will also provide quick access to shares (volumes) and the Dashboard. See [LaCie Network Assistant](#) for instructions.
- **Configure your NAS:** For details on how to configure and use your LaCie NAS, go to [Shares: Access and Transfer Files](#) and [NAS OS Administration](#).

# CONNECT TO THE NETWORK: DISKLESS LACIE 2BIG NAS

Users who purchased a LaCie 2big NAS enclosure without hard disks should follow the instructions below.

**Enclosure with hard disks:** If you purchased an enclosure with hard disks, see [Connect to the Network](#) for instructions on how to connect to your network.

## CHOOSE COMPATIBLE HARD DRIVES

Review the following before adding hard drives to your LaCie 2big NAS:

- When adding a new hard drive to the enclosure, consider a [LaCie 2big Spare Drive](#). LaCie hard drives are specially prepared and optimized for use with LaCie NAS.
- LaCie NAS are compatible with most SATA II and SATA III hard drives. Go to [Network Hard Drives](#) for a list of hard drives tested with the 2big NAS. If you have any issues with hard drive compatibility and LaCie products, please contact our tech support.
- LaCie recommends selecting disks that are equal in storage capacity. For example, if the first disk slot has a 1TB hard disk, fill the second slot with a 1TB hard disk.

## INSTALLATION STEPS

Step 1: Connect and power on the diskless 2big NAS

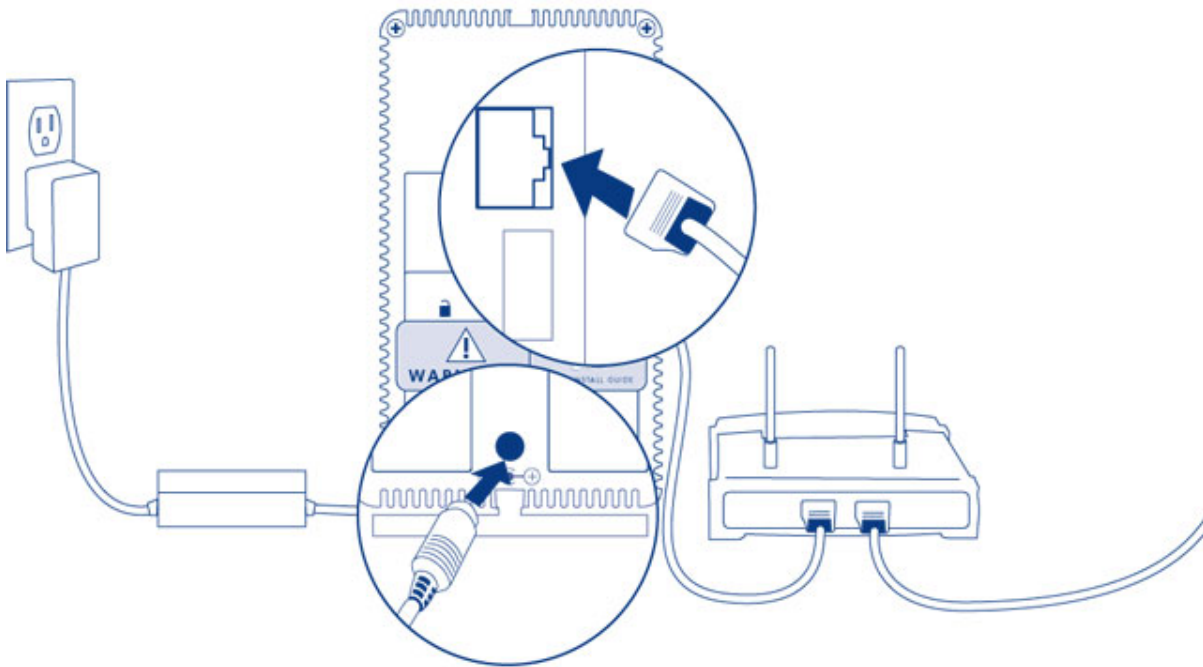

1. Make sure that the disk slots are empty. You will be prompted to insert disks in Step 3.
2. Connect the Ethernet cable to the Ethernet port on the back of the product and to an available Ethernet port on your router. Refer to your router's documentation if necessary.
3. Connect the power supply to a wall outlet and to the product.
4. Push the power button on the back of the device to the **ON** position. The front LED will turn on and then begin blinking blue. Once the LED stops blinking, move on to the next step.

Step 2: Remove the disk tray sticker and empty disk tray(s)

**Note on illustrations:** To reduce complexity in the images, the Ethernet and Power cables have been removed. LaCie recommends that you maintain both connections while continuing with the installation steps.

1. Remove the sticker from the back of the device.

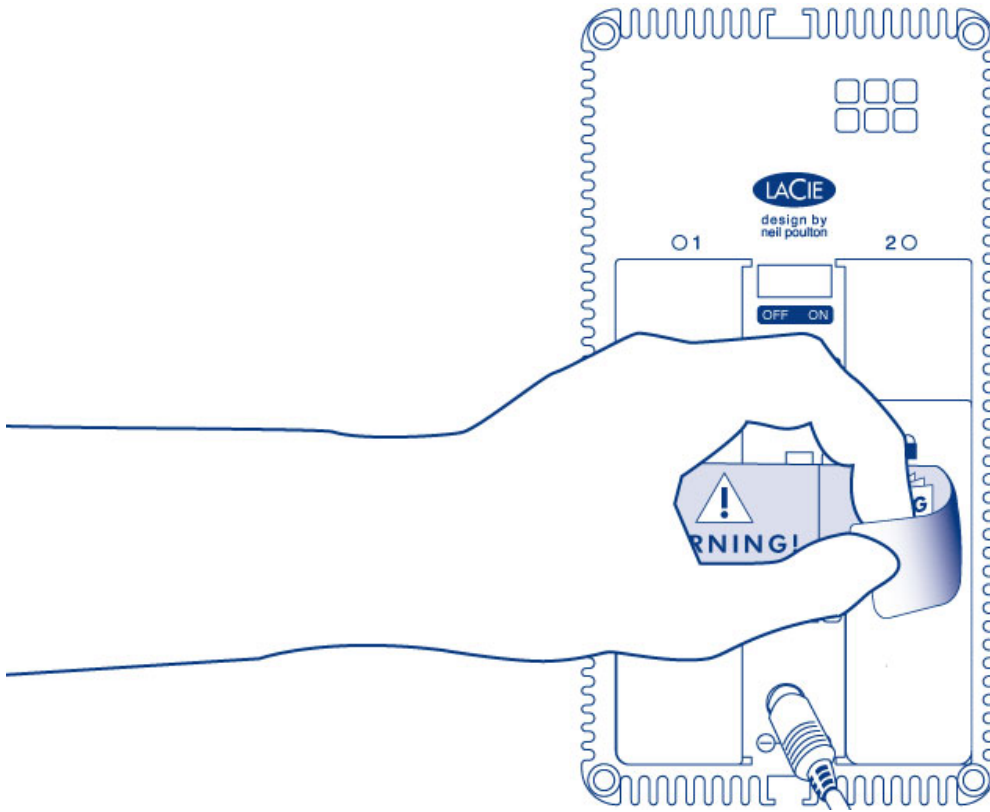

2. The disk tray(s) may be locked. To unlock, use the included disk drawer key to turn the lock until the slot is vertical.

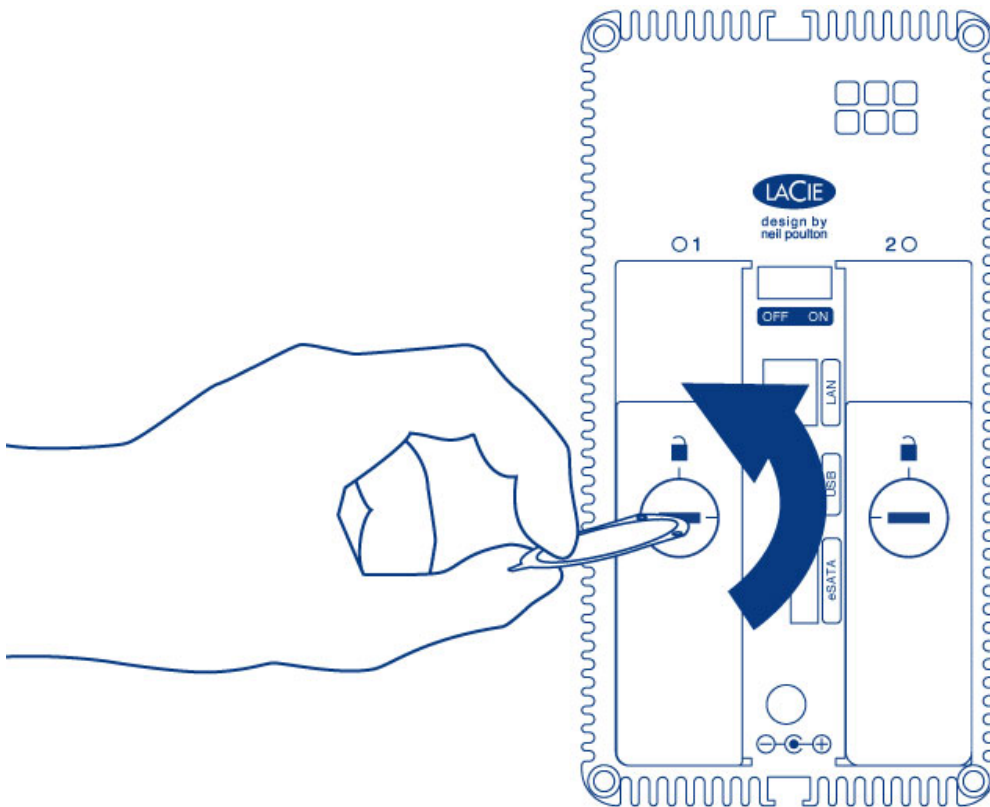

3. Draw out the disk tray by inserting your finger into the space behind the disk tray handle and pulling to disengage it.

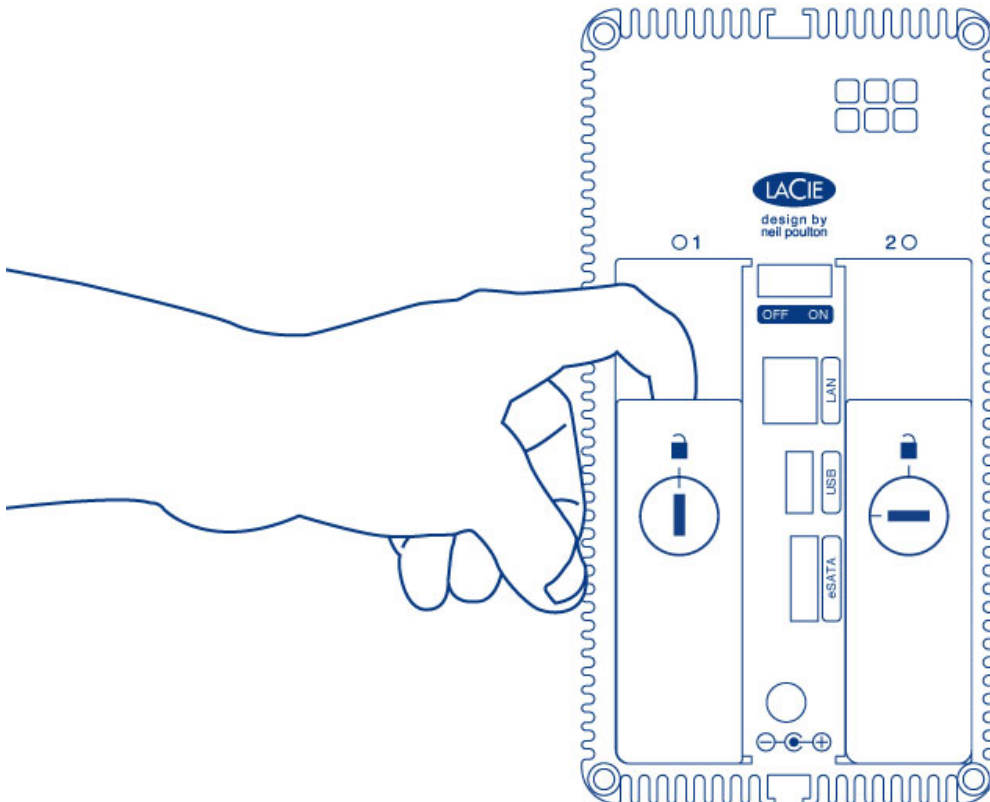

4. Grasp the disk tray handle and carefully extract it.

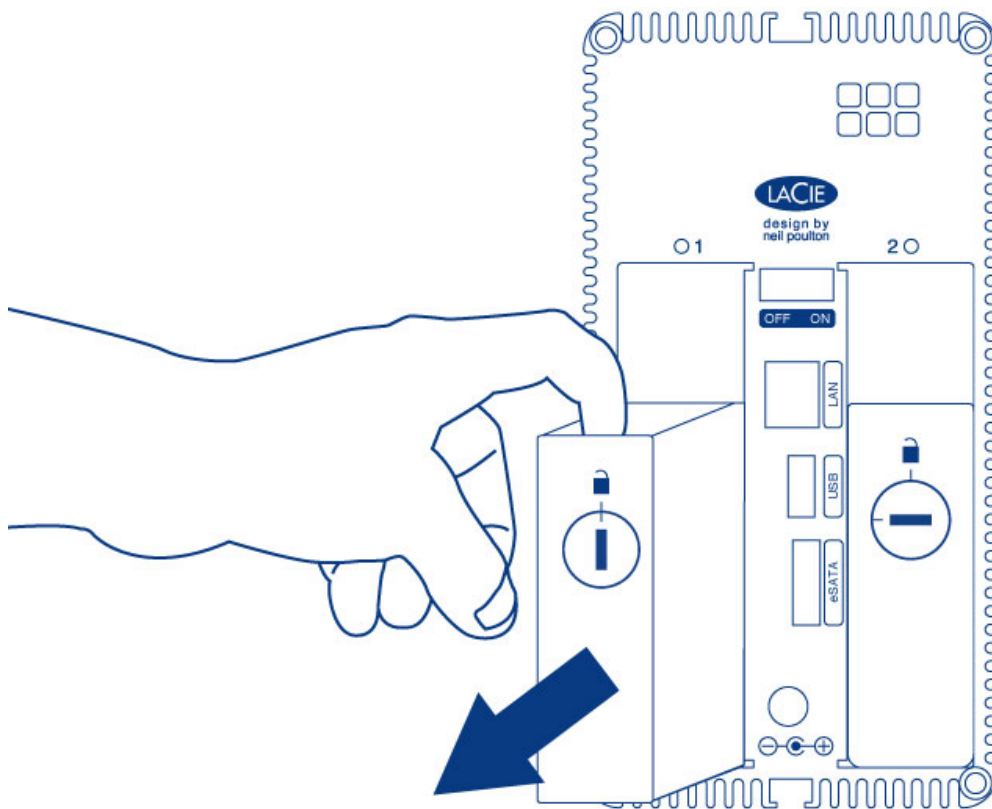

5. Repeat the process if you are adding a second disk.



### Step 3: Install the disks into the disk trays

Find a suitable work area with adequate space and a flat, even surface. Make certain that all necessary components are available:

- LaCie 2big NAS disk tray
- Hard disk
- Disk tray screws. Use only the screws that are provided with your LaCie NAS.
- Phillips head screwdriver. Make certain that the screwdriver is the correct size for the disk tray screws.

**Caution:** To avoid potential problems caused by electrostatic discharge (ESD), it is recommended that you do not touch the hard disk's printed circuit board. As a further precaution against ESD, use an anti-static wristband or an anti-static mat to ground yourself when handling the hard disk.

To secure the disk in the disk tray:

1. Place the empty disk tray onto the flat work area with the handle on the bottom left.
2. Many disks have a label on one side and the printed circuit board on the opposite side. With its label side facing up, gently place the hard disk within the disk tray. Keep the side with the printed circuit board on the work space and the SATA connector facing to the right. The four tray screw slots should align with the disk's four screw holes.
3. Use the Phillips head screwdriver to fasten all four screws into the four tray slots. Do not overly tighten the screws. Doing so can affect the integrity of the screw holes on the disk as well as the threads on the screws.

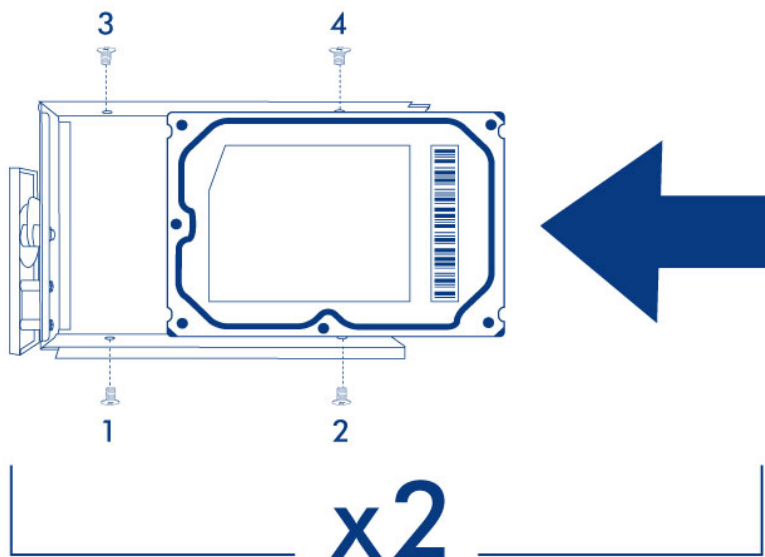

4. Repeat the process if you are installing two disks.

#### Step 4: Insert the full disk trays

**Note on illustrations:** To reduce complexity in the images, the Ethernet and Power cables have been removed. LaCie recommends that you maintain both connections while continuing with the installation steps.

1. Carefully insert the full disk tray into an empty disk slot. You will feel resistance when the disk tray is most of the way in the bay. Gently push the disk tray handle firmly until you feel it snap into place. The disk tray handle should be flush with the back of the enclosure.

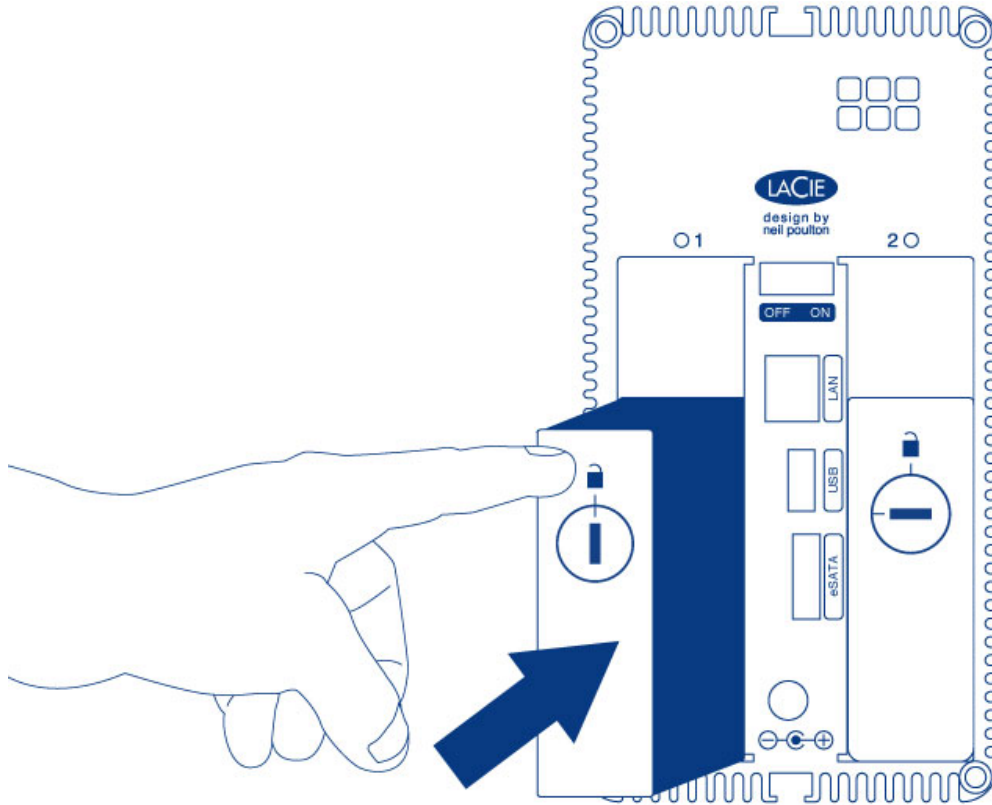

2. If you are adding the second disk, insert it next.
3. Use the disk lock tool to lock the disk(s) in place.

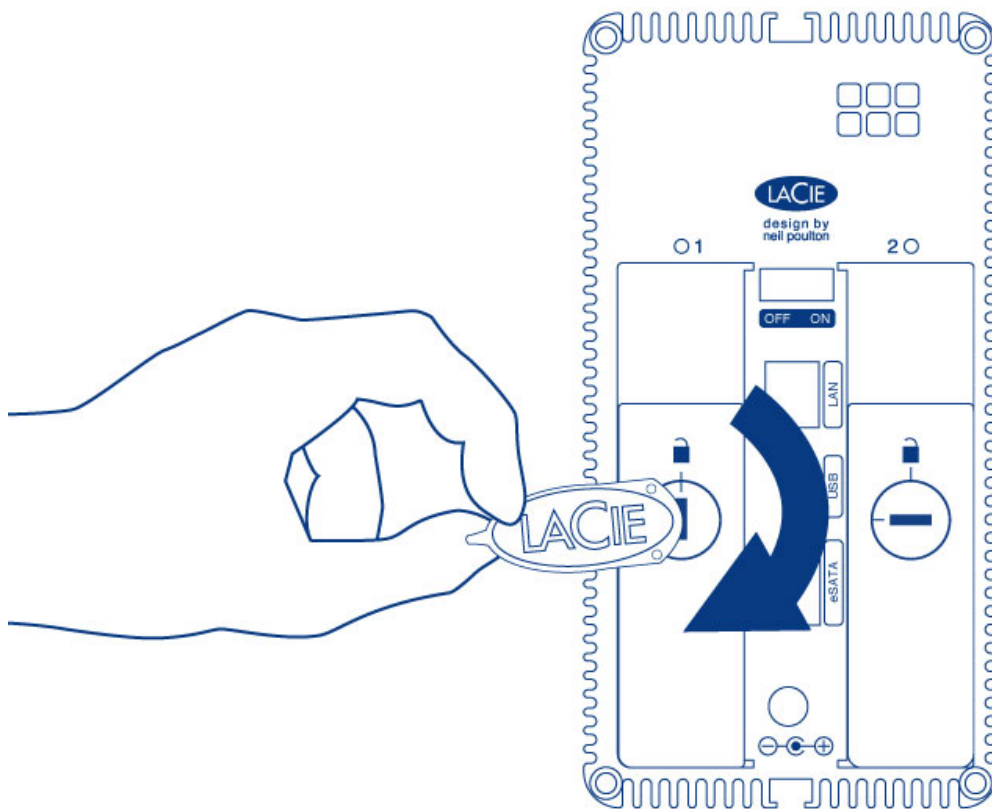

4. The disk LEDs on the rear of the product will blink blue. Wait a full minute before moving on to the next step.

Step 5: Initialize the new disks

During this process, **the hard disks you have inserted into the LaCie NAS will be formatted and all data deleted.**

1. Press and hold the front button for at least 5 seconds. Once the LED begins to blink blue and red, release the button.

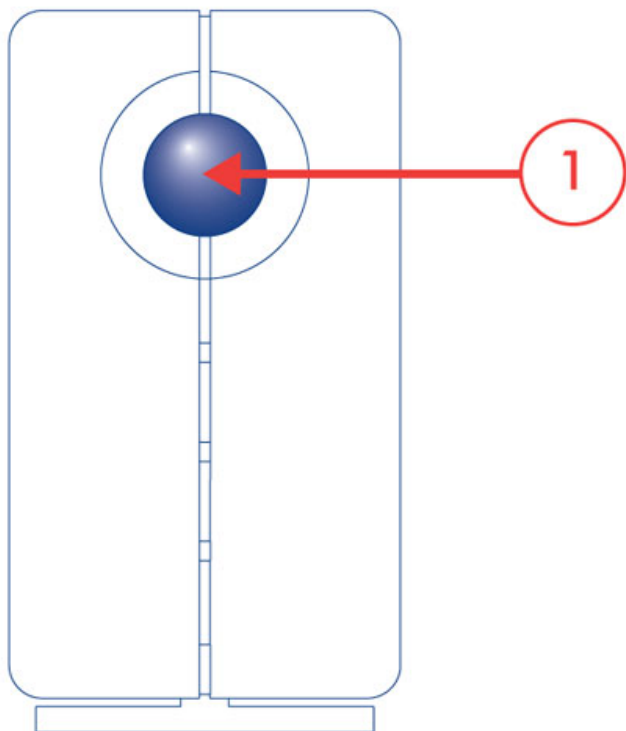

2. After a period of 10 to 16 minutes, initialization will have completed. The system is ready once the front LED turns solid blue.

Step 6: Access the LaCie NAS Dashboard

**Note:** The steps below should be completed by the NAS's administrator.

Perform the steps below on a PC/Mac connected to the same network as your LaCie NAS.

1. Launch your preferred internet browser and type the default address for the LaCie NAS:
  - *Windows workstations (no Bonjour)* - <http://lacie-2big-nas>
  - *Mac OS X and Windows workstations running Bonjour* - <http://lacie-2big-nas.local>
2. The Dashboard will prompt you to create an administrator password. You may also change:
  - The name of the device (the default is *LaCie-2big-NAS*).
  - The administrator login (the default is *admin*).
  - The time zone.



3. Make certain to note your login and password for future use.
4. Choose **Finish** to access the Dashboard Home page.

### Dashboard

- General Settings
- Users
- Shares
- Download
- Eco management
- Hardware monitoring
- Network
- Groups
- Backup
- Storage
- Support

**Users** X  
1 User  
In 0 group

**Shares** X  
3 Shares  
1 public share

**Storage** X  
Volume 1 3 TB  
ISCSI

**General Settings** X  
LaCie-2big-NAS  
On Workgroup  
18 THUR APR, 2013  
15:50

**Network** X  
IP address 192.168.10.27  
Proxy configuration  
Remote access  
Automatic port forwarding

**Hardware monitoring** X  
OK Drive

Users, Backup, Download, Eco management, Support icons

## Next steps

- **Simplify NAS access:** LaCie recommends that you install the software utility *LaCie Network Assistant* before moving forward with the device configuration. LaCie Network Assistant gives you instant information on your LaCie NAS, such as firmware version, IP address, and hardware address. It will also provide quick access to shares (volumes) and the Dashboard. See [LaCie Network Assistant](#) for instructions.
- **Configure your NAS:** For details on how to configure and use your LaCie NAS, go to [Shares: Access and Transfer Files](#) and [NAS OS Administration](#).

# CONNECT TO THE NETWORK: DISKLESS LACIE 5BIG NAS PRO

Users who purchased a LaCie 5big NAS Pro enclosure without hard disks should follow the instructions below.

**Enclosure with hard disks:** If you purchased an enclosure with hard disks, see [Connect to the Network](#) for instructions on how to connect to your network.

## CHOOSE COMPATIBLE HARD DRIVES

Review the following before adding hard drives to your LaCie 5big NAS Pro:

- When adding new hard drives to the enclosure, consider [LaCie 5big Hard Drives](#). LaCie hard drives are specially prepared and optimized for use with LaCie NAS.
- LaCie NAS are compatible with most SATA II and SATA III hard drives. Go to [Network Hard Drives](#) for a list of hard drives tested with the 5big NAS Pro. If you have any issues with hard drive compatibility and LaCie products, please contact our tech support.



## INSTALLATION STEPS

### Step 1: Update the LaCie USB key

The included USB flash drive allows you to boot the LaCie 5big NAS Pro and run the NAS OS Rescue and Install (LaCie key). However, before running the Rescue and Install, it is highly recommended that you download a more recent version of the software as it may have been updated since you received your NAS.



The software that you download onto the LaCie key NAS is not the NAS OS. Rather, it is a utility to run the NAS OS Rescue and Install so that you can install or repair the NAS OS.

To update the LaCie key:

1. Insert it into a USB port on a computer with a connection to the internet.
2. Launch an internet browser and enter the following address: <http://www.lacie.com/lakeynas>
3. Follow the onscreen directions to update the software on the LaCie key.
4. Eject the key from your computer.



In Step 5 below, the setup wizard will ask you to enter a MAC address unique to your enclosure. You can get a MAC address by:

- looking on the bottom of your LaCie 5big NAS Pro enclosure for a sticker. It has two numbers that correspond to **LAN 1** and **LAN 2**. Use one of the two numbers as the MAC address.
- connecting a VGA monitor to the VGA port located on the back of the LaCie 5big NAS Pro. Following the initial boot process (Step 3), the system will provide the MAC and IP addresses. If the monitor is receiving a signal but the image is black, try connecting a USB keyboard to one of the USB ports also located on the back of the 5big NAS Pro. The system may have reverted to energy conservation mode which you can exit by striking one of the keys on the USB keyboard.

Step 2: Connect the Ethernet cable, power cable, and LaCie key

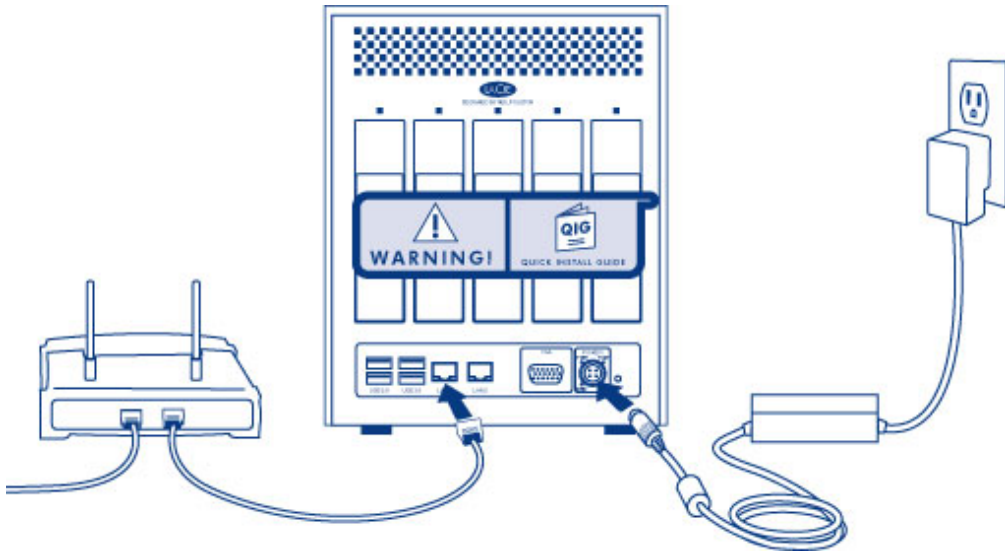

1. Connect the Ethernet cable to the Ethernet port on the back of the product and to an available Ethernet port on your router. Refer to your router’s documentation if necessary.
2. Connect the power supply to a wall outlet and to the product.
3. Connect the LaCie key to one of the USB ports on the LaCie 5big NAS Pro.

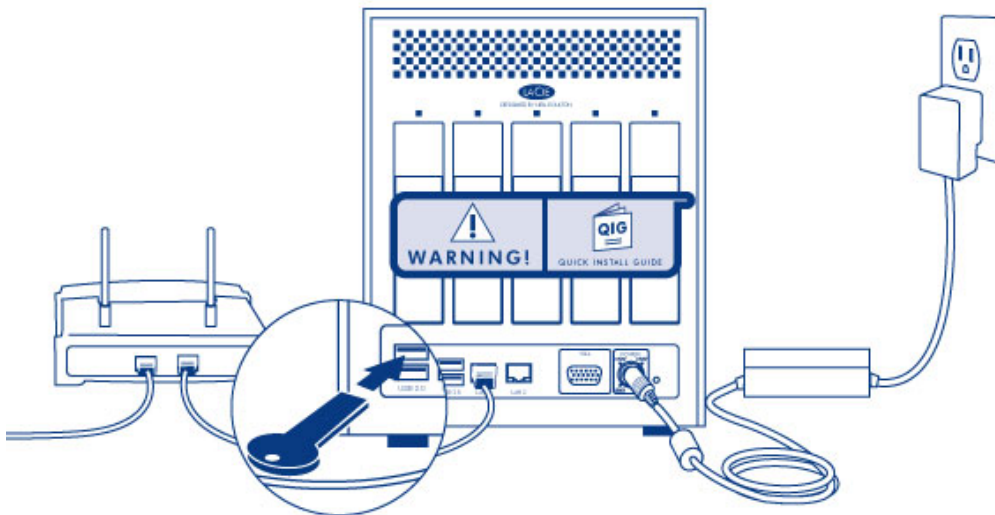

**Caution:** Only use the AC adapter supplied with your specific LaCie device. Do not use a power supply from another LaCie device or another manufacturer. Using any other power cable or power supply may cause damage to the device and void your warranty. Always remove the AC adapter before transporting your LaCie device. Failure to remove the adapter may result in damage and will void your warranty.

Step 3: Remove the sticker and power on the 5big NAS Pro

1. Remove the sticker on the back of the enclosure.

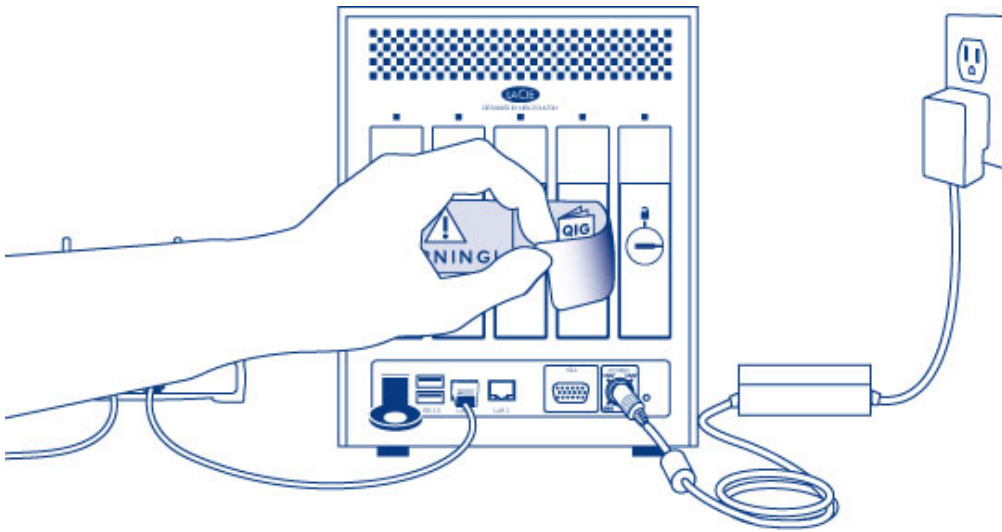

2. Press the front LED button to power on the device.

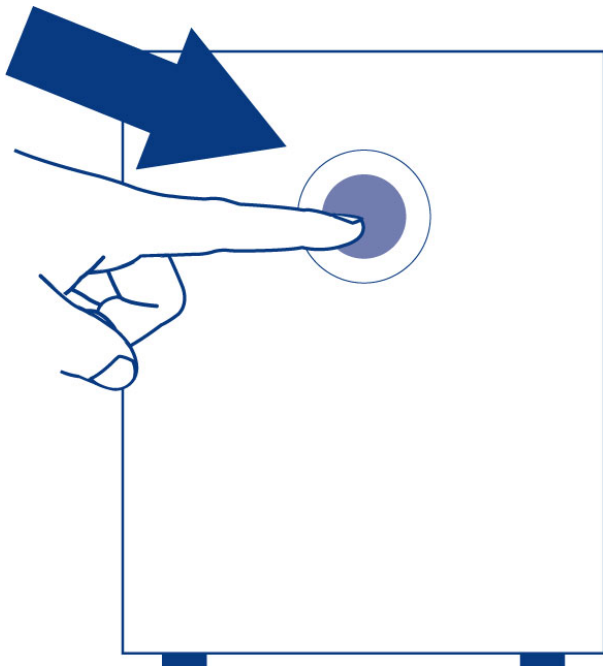

**Important info:** Power the device on before inserting hard disks into the drive slots.

Step 4: Install hard drives into the enclosure

Add new hard drives in the order of the numbered slots, from left to right.

**Remove the empty disk trays:**

1. Use the included drawer key to unlock the disk tray. Turn the lock until it is vertical.

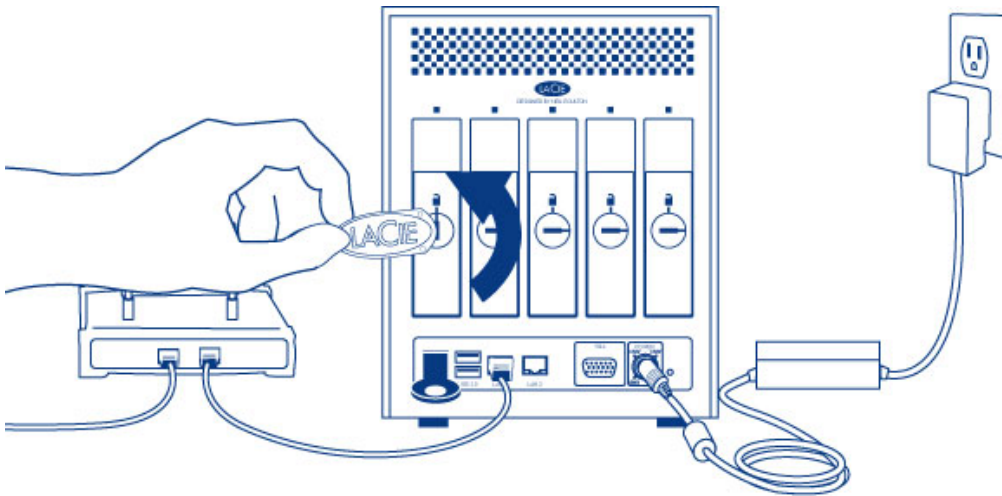

2. Place your index finger into the space behind the handle then carefully remove the disk tray.

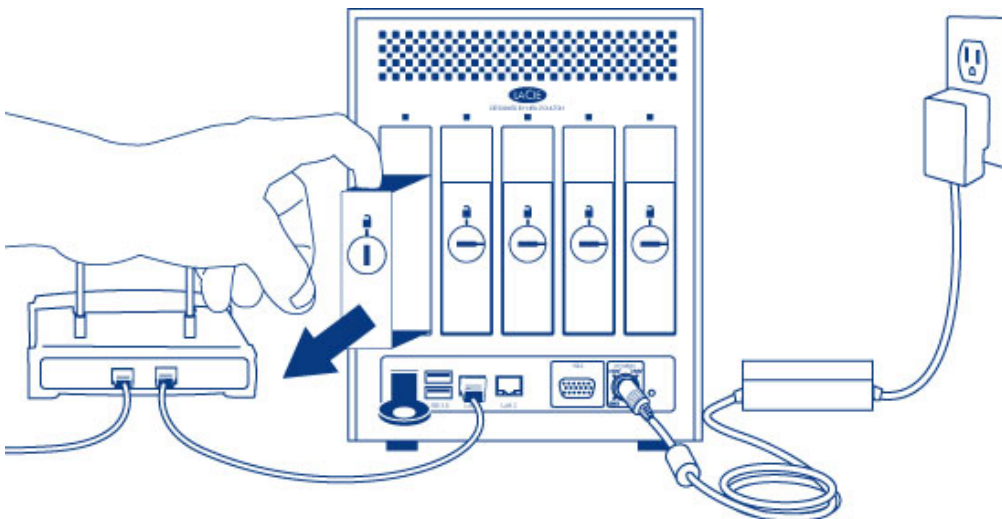

3. Remove additional trays if you are adding more than one hard disk. Make certain to remove the disk trays in the proper slot order.

**Fasten the hard drive to the hard disk tray:**

Find a suitable work area with adequate space and a flat, even surface. Make certain that all necessary components are available:

- LaCie 5big NAS Pro Hard Disk Tray
- Hard drive
- Hard disk tray screws. Use only the screws that are provided with your LaCie NAS.
- Phillips head screwdriver. Confirm that the head of the screwdriver is the proper size for the disk tray screws.

**Secure a hard drive to the hard disk tray:**

1. Place the empty hard drive tray onto the flat work area with the handle on the bottom left.
2. Many hard disks have a label on one side and the printed circuit board on the opposite side. With its label

side facing up, gently place the hard disk within the hard drive tray. Keep the side with the printed circuit board on the work space and the SATA connector facing to the right. The four tray screw slots should align with the hard disk's four screw holes.

3. Use the Phillips head screwdriver to fasten all four screws into the four tray slots. Do not overly tighten the screws. Doing so can affect the integrity of the screw holes on the hard drive as well as the threads on the screws.

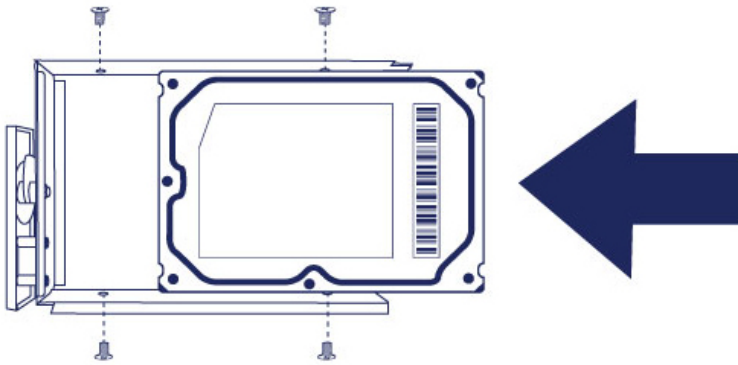

4. Repeat the process if you are adding more than one hard disk.
5. Carefully insert the full hard drive tray into the empty disk slot 1 (far left). You will feel resistance when the hard drive tray is most of the way in the bay. Gently push the hard drive tray handle firmly until you feel it snap into place.

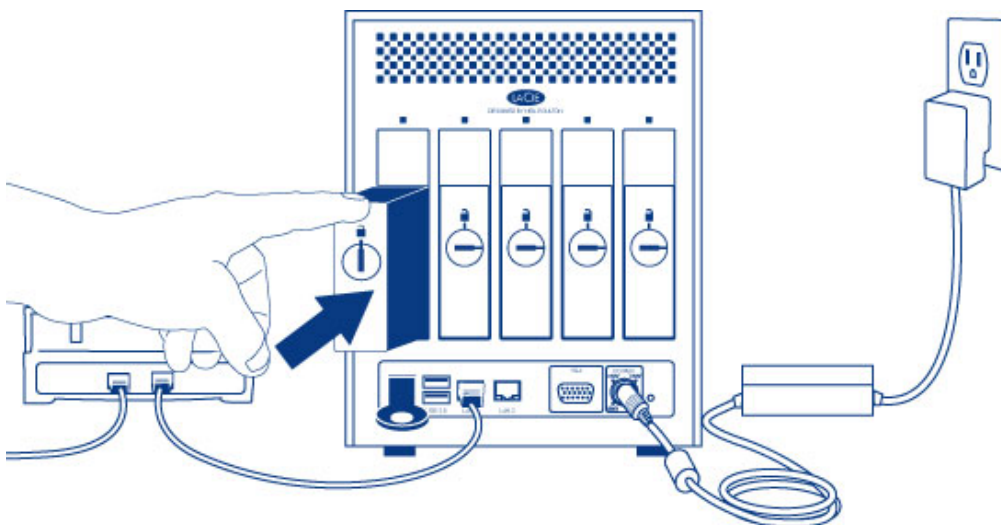

6. Once the disk tray handle is flush with the back of the enclosure, you can lock it.

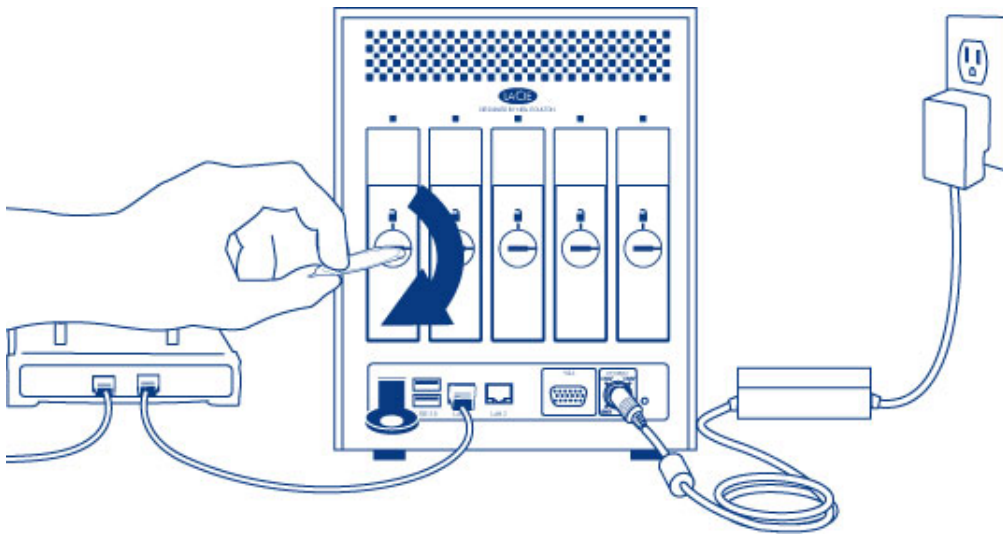

7. If you are adding more than one hard disk, insert full hard drive trays into empty slots in the enclosure. Make certain to follow the slot numbers. For example, the second hard disk should be inserted into disk slot 2, the third disk into disk slot 3, etc.

## Step 5: Install LaCie NAS OS

**Note:** The steps below should be completed by the NAS's administrator.

Perform the steps below on a PC/Mac connected to the same network as your LaCie 5big NAS Pro. During this process, **the hard disks you have inserted into the 5big NAS Pro will be formatted and all data deleted.**

1. Launch your preferred internet browser and type the default address for the LaCie NAS:
  - *Windows workstations (no Bonjour)* - <http://lacie-5big-pro>
  - *Mac OS X and Windows workstations running Bonjour* - <http://lacie-5big-pro.local>.

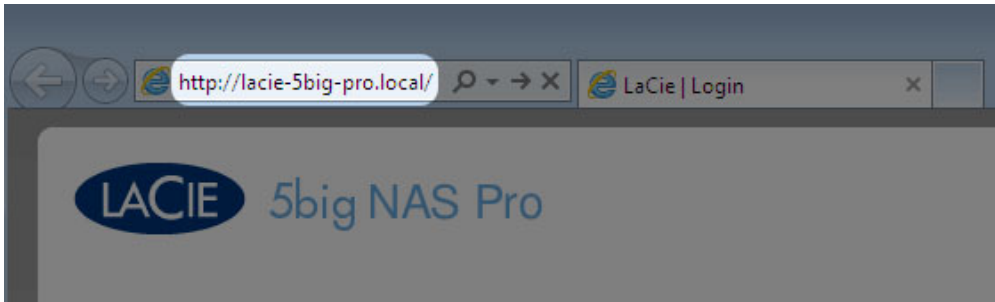

If you cannot reach the setup wizard using the name of the device, connect a VGA monitor to the VGA port located on the back of the 5big NAS Pro. Following the initial boot process, the system will indicate MAC and IP addresses.

If the monitor is receiving a signal but the image is black, try connecting a USB keyboard to one of the USB ports on the back of the device. The system may have reverted to energy conservation mode which you can exit by striking one of the keys on the USB keyboard.

2. The LaCie 5big NAS Pro Rescue wizard will appear.



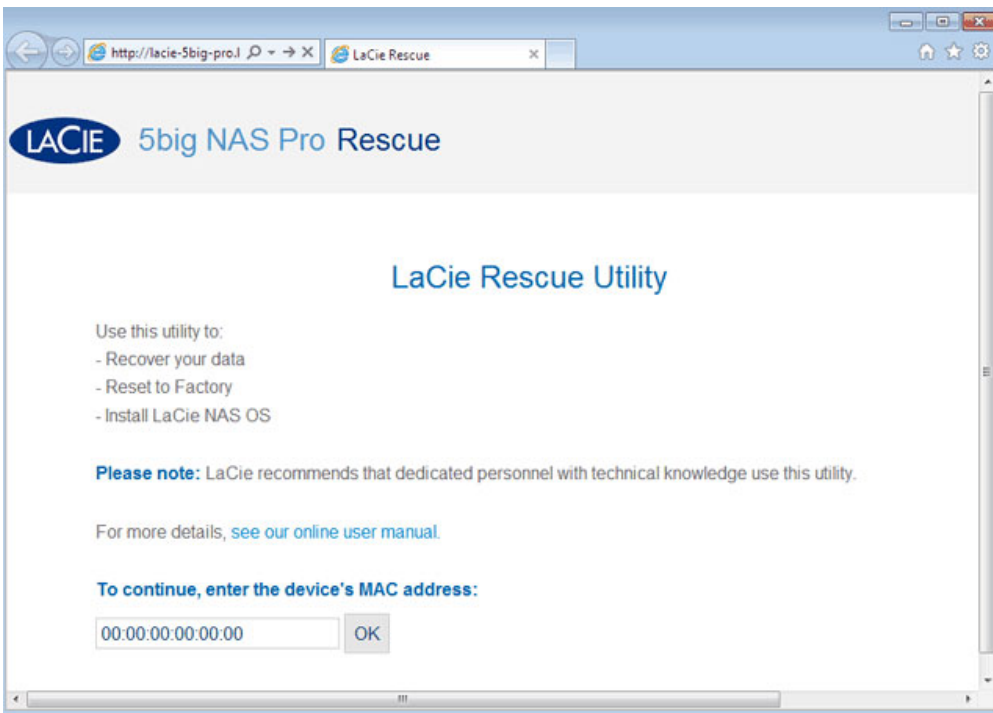

3. To continue, enter one of the MAC addresses that you noted in Step 1. It is not necessary to enter the colons.

**To continue, enter the device's MAC address:**

4. Choose **Start Install**.

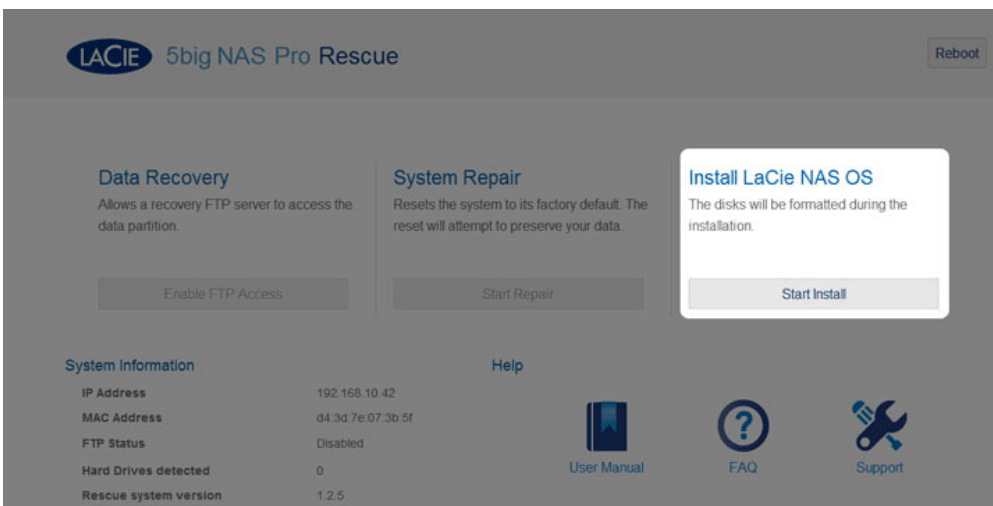

5. Choose **Continue** at the prompt to install LaCie NAS OS on the hard disk(s). To accommodate the installation, **all data stored on the hard disks will be deleted.**

---

## Install NAS OS

---

The new disk(s) will be formatted.

⚠ All data will be deleted during the disk format.

6. It will take approximately five minutes to format the hard drive(s) and install LaCie NAS OS. Once it is finished, the Dashboard will prompt you to create an administrator password. You may also change:

- The name of the device (the default name is *LaCie-5big-Pro*).
- The administrator login (the default login is *admin*).
- The time zone.



1. Update      2. Settings

**Authentication**

Product name   
To identify your 5big Pro NAS on your local network.

Administrator login

Password

Confirm your password

**Timezone**

(GMT+01:00) Brussels, Copenhagen, Madrid, Paris  
(GMT+01:00) Sarajevo, Skopje, Warsaw, Zagreb

**All Time Zones**

(GMT+12:00) Eniwetok, Kwajalein  
(GMT-11:00) Samoa Standard Time; Midway Is.  
(GMT-10:00) Hawaii Standard Time  
(GMT-09:00) Alaska Standard Time  
(GMT-08:00) Pacific Time (US & Canada); Tijuana

7. Make certain to note your login and password for future use.

8. Choose **Finish** to access the Dashboard Home page. You may remove the LaCie key from the device. Keep it in a safe location for future use.

### Dashboard

- General Settings
- Users
- Shares
- Backup
- Drive Information
- Eco Management
- Network
- Groups
- External ports
- Download
- RAID
- Support

**Users** X  
1 User  
In 0 Groups

**Groups** X  
0 Group  
For 0 Users

**Shares** X  
3 Shares  
2 Public Shares

**General Settings** X  
LaCie-5big-Pro  
On Workgroup  
9:15  
15:1

**Network** X  
IP Address: 192.168.10.42  
Direct Internet connection:   
Remote Access:   
Automatic port forwarding:

**Drive Information** X  
Network drive: 995.1 GB  
0%  
iSCSI: 0 B  
0%

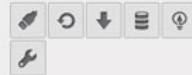

## Next steps

- **Simplify NAS access:** LaCie recommends that you install the software utility *LaCie Network Assistant* before moving forward with the device configuration. LaCie Network Assistant gives you instant information on your LaCie NAS, such as firmware version, IP address, and hardware address. It will also provide quick access to shares (volumes) and the Dashboard. See [LaCie Network Assistant](#) for instructions.
- **Configure your NAS:** For details on how to configure and use your LaCie NAS, go to [Shares: Access and Transfer Files](#) and [NAS OS Administration](#).

# LACIE NETWORK ASSISTANT

LaCie Network Assistant is a software utility that will help you detect and access LaCie NAS connected to your network. Use LaCie Network Assistant for instant information on the device's:

- IP address
- Version of software/firmware
- MAC address (hardware ID number)

LaCie Network Assistant can also help you:

- Launch the Dashboard
- Mount one or more shares
- Auto-mount one or more shares
- Update your product's firmware (2big NAS only, see [Update Firmware](#))

**Important info on LaCie Network Assistant and the LaCie 5big NAS Pro LAN Ports:** LaCie Network Assistant will always provide information on LAN 1, even if you have connected the NAS to your network using LAN 2.

## INSTALL LACIE NETWORK ASSISTANT

**LaCie Network Assistant is already installed:** To avoid NAS detection conflicts, make certain that you are running the latest version of LaCie Network Assistant. If you have already installed LaCie Network Assistant, go to the product [website](#) to confirm it is up to date.

Choose one of the options below:

Install Using the included CD-ROM

1. Insert the Utilities CD-ROM into your computer's CD-ROM drive.
2. Launch **LaCie Network Assistant Setup**.
3. Follow the wizard to complete the installation.

Install via the LaCie Website

Download LaCie Network Assistant from [here](#), then follow the easy installation directions.

## LAUNCH LACIE NETWORK ASSISTANT

LaCie Network Assistant will automatically detect your LaCie device(s) on the network. Review the steps below to access your device.

### ▪ Windows Users:

1. Select LaCie Network Assistant in **Start > All Programs/Programs**. The application icon will appear in the system tray.
2. Right-click on the icon in the system tray.



### ▪ Mac Users:

1. Select LaCie Network Assistant at **Go > Applications > LaCie Network Assistant**. The application icon will appear in the menu bar.
2. Select the icon in the menu bar.



## FIND YOUR LACIE NAS'S ADDRESS INFORMATION

1. Launch LaCie Network Assistant.
2. **Windows users:** Select the LaCie Network Assistant icon to choose **Open LaCie Network Assistant**.

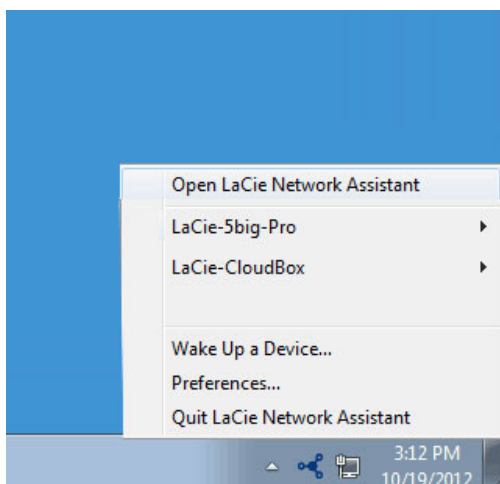

**Mac users:** Choose the LaCie Network Assistant icon in the menu bar to select **Open LaCie Network Assistant...**

3. If you have more than one LaCie network device, select your LaCie NAS from the list of devices in the left-hand column.
4. Choose the **Configuration** tab.

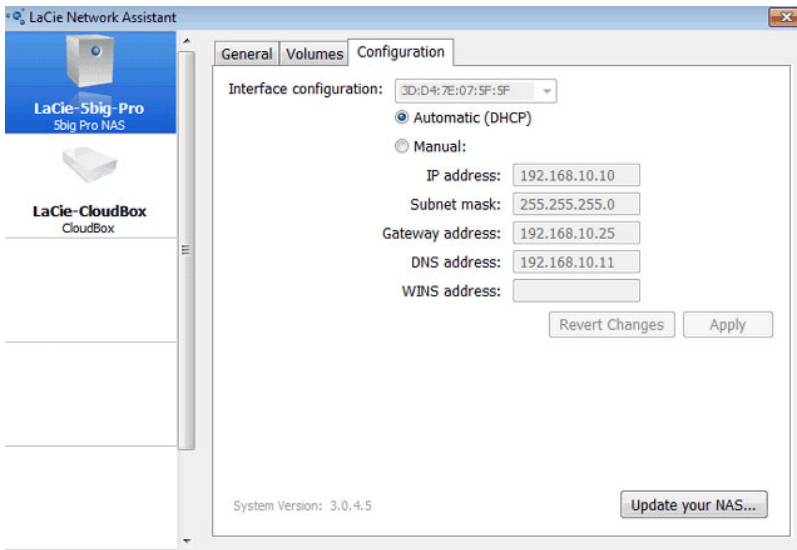

5. Review the device's:
  - IP address
  - MAC address (hardware ID)
  - Version of software

## ACCESS THE DASHBOARD WITH LACIE NETWORK ASSISTANT

1. Launch LaCie Network Assistant.
2. Choose your device:
  - Windows: Right-click on the LaCie Network icon in the system tray to select your LaCie NAS.
  - Mac: Choose the LaCie Network Assistant icon in the menu bar to select your LaCie NAS.
3. Select **Web access**.
4. The Dashboard login page will launch in an internet browser.

## MOUNT SHARES

LaCie Network Assistant gives you many options to access your LaCie NAS's public and private shares.



## Quick access

1. If LaCie Network Assistant is not running, launch the program.
2. To select the LaCie NAS on your network, do one of the following.
  - Windows: From the system tray, right-click on the LaCie Network Assistant icon and select the LaCie NAS.
  - Mac: From the menu bar, select the LaCie Network Assistant icon and choose your LaCie NAS.
3. Choose the share you want to access.

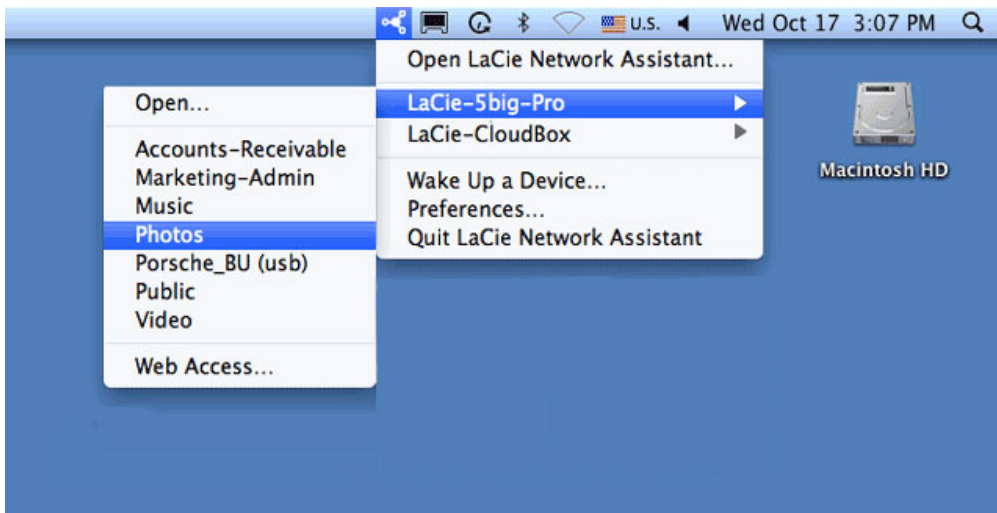

4. The share will open in an Explorer window (Windows) or a Finder window (Mac).

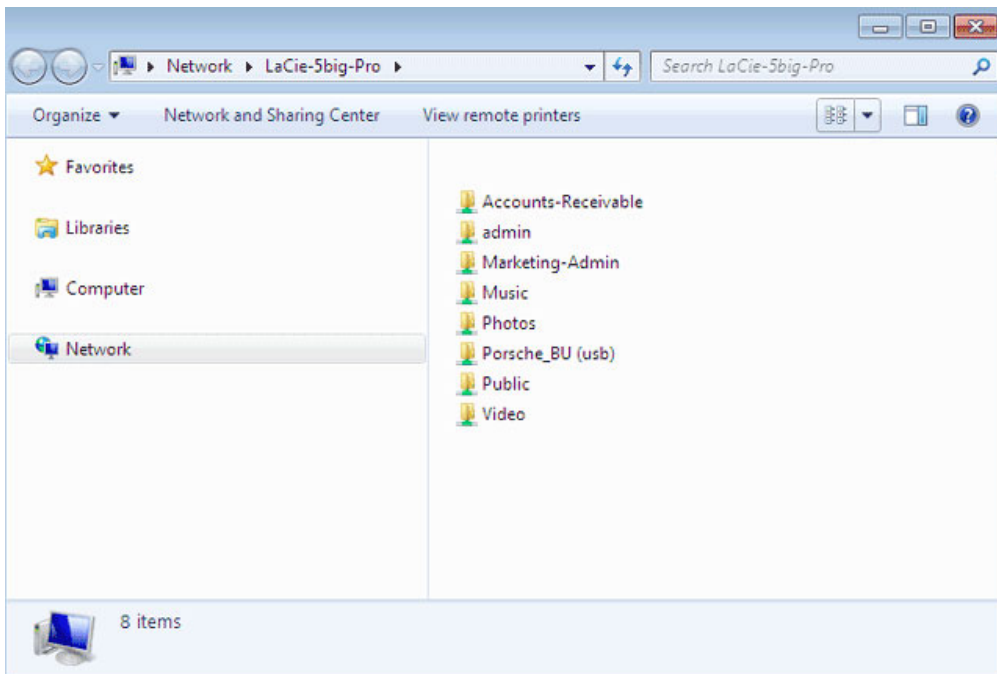

5. Public shares are available to everyone on the network. Private shares will prompt a user for a username and password (see [Authenticate private shares](#) to learn how to avoid entering the password). The administrator should use the credentials created during the initial setup or Dashboard login (see [Connect to the Network/Connect to the Network: Diskless LaCie 2big NAS/Connect to the Network: Diskless LaCie 5big NAS Pro](#) and [NAS OS Administration](#)). A user should type the login and password prepared by the administrator (see [Users](#) ).

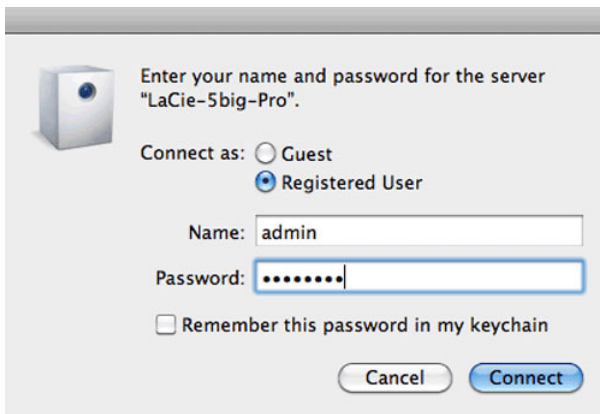

6. Transfer files normally between your computer and the share. Mac users: If the share does not open in a Finder window, simply navigate in the Finder to **SHARED > [machine name] > [share name]**.

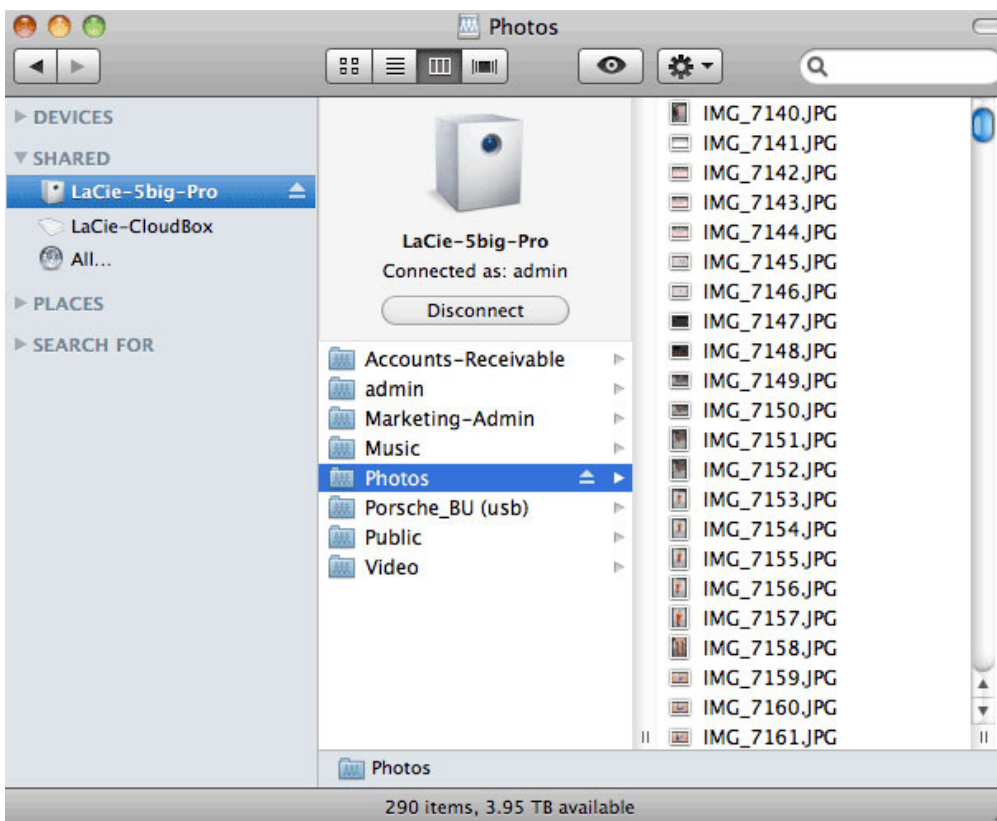

**Note on Quick Access to shares:** Private shares require a valid username and password (see [Authenticate for Private Shares](#)).

## Mount

1. If LaCie Network Assistant is not running, launch the program.
2. Right-click on the icon in the system tray (Windows) or choose the icon in the menu bar (Mac) and select **Open LaCie Network Assistant**.
3. Select your LaCie NAS's machine name from the list of devices in the left-hand column, then choose the **Volumes** tab.

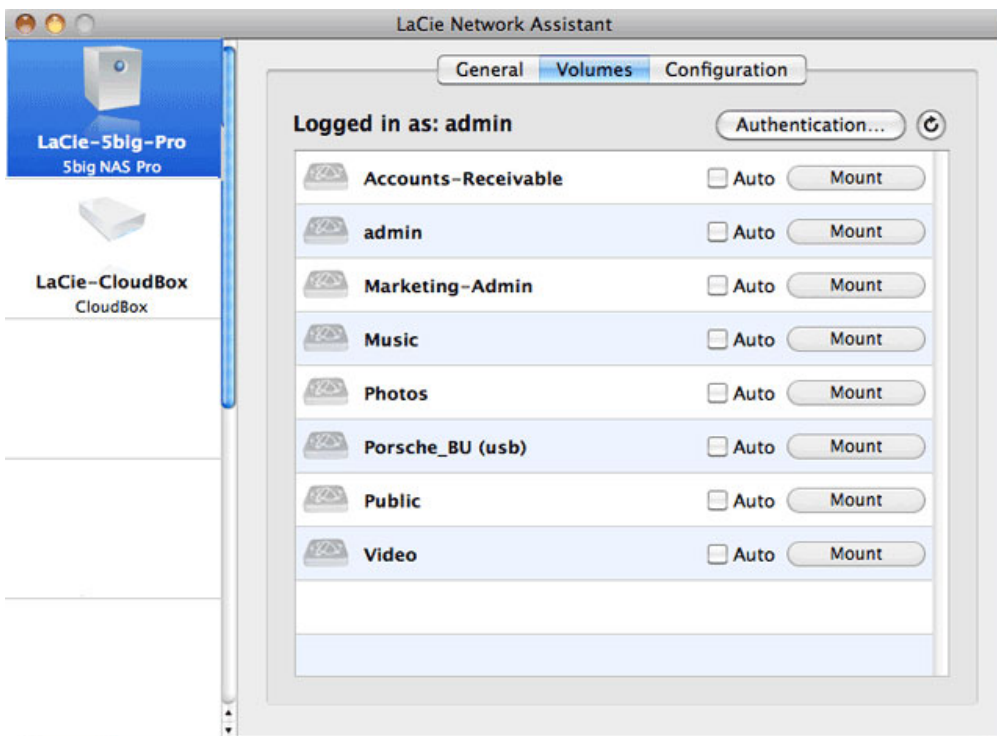

4. Double-click the share you wish to access. The share will open in an Explorer window (Windows) or a Finder window (Mac). Transfer files normally from your computer to the share.

**Technical note:** Mac users: If the share does not open in a Finder window, simply navigate in the Finder to **Network > [machine name] > [share name]**.

**Note on mounting shares:** Private shares require a valid username and password (see [Authenticate for Private Shares](#)).

## Authenticate private shares

1. If LaCie Network Assistant is not running, launch the program.
2. Right-click (Windows) on its icon in the system tray or select it in the menu bar (Mac).
3. Choose **Open LaCie Network Assistant**.
4. If you have more than one LaCie NAS, select the device you wish to access from the list in the left-hand column.
5. Choose the **Volumes** tab.

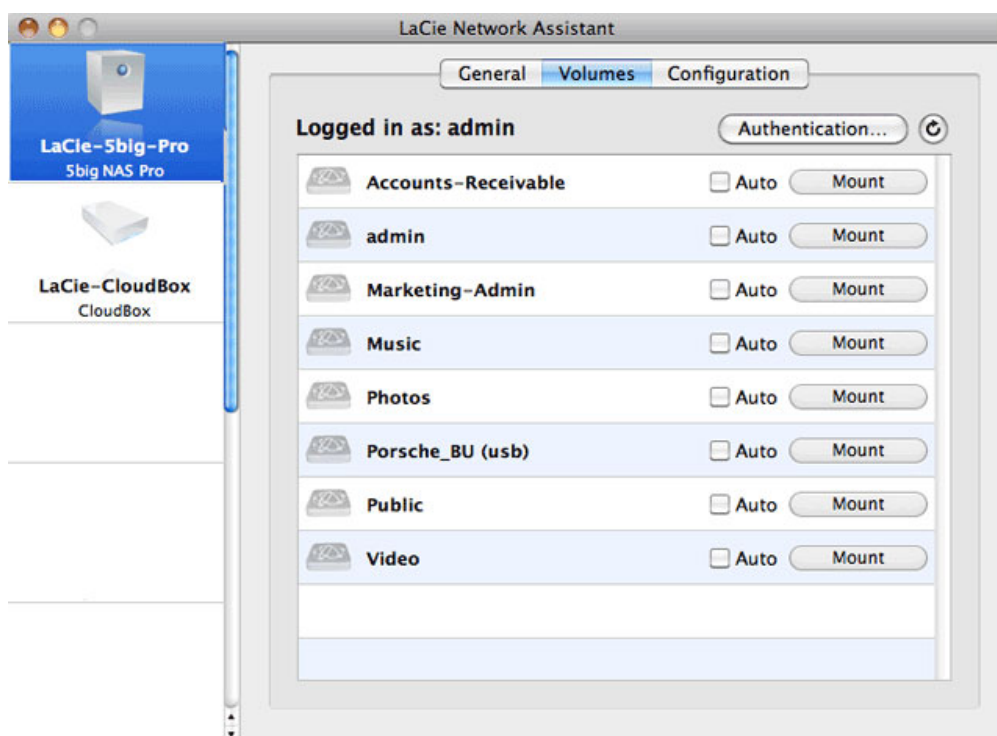

6. Select **Authentication...**
7. In the pop-up window, choose **Registered User** and enter your Username and Password. Select **OK**.
8. All available shares will appear in the list of volumes.
9. Select **Mount as drive** (Windows) or **Mount** (Mac) to open the share.
10. The share will be available in an Explorer window (Windows) or a Finder window (Mac).

## Auto-mount

1. If LaCie Network Assistant is not running, launch the program.
2. Right-click (Windows) on its icon in the system tray or select it in the menu bar (Mac).
3. Choose **Open LaCie Network Assistant**.
4. If you have more than one LaCie NAS, select the device you wish to access from the list in the left-hand column.
5. Choose the **Volumes** tab.
6. If the share you wish to auto-mount is private, choose **Authentication...** to enter your credentials. In the pop-up window, choose **Registered User** and enter the Username and Password for the share. Click **OK**. All available shares will appear in the list of volumes.
7. Select the checkbox for **Auto** to open the share. The share will now mount each time you boot the computer. To cancel auto-mount, uncheck the box for **Auto**.

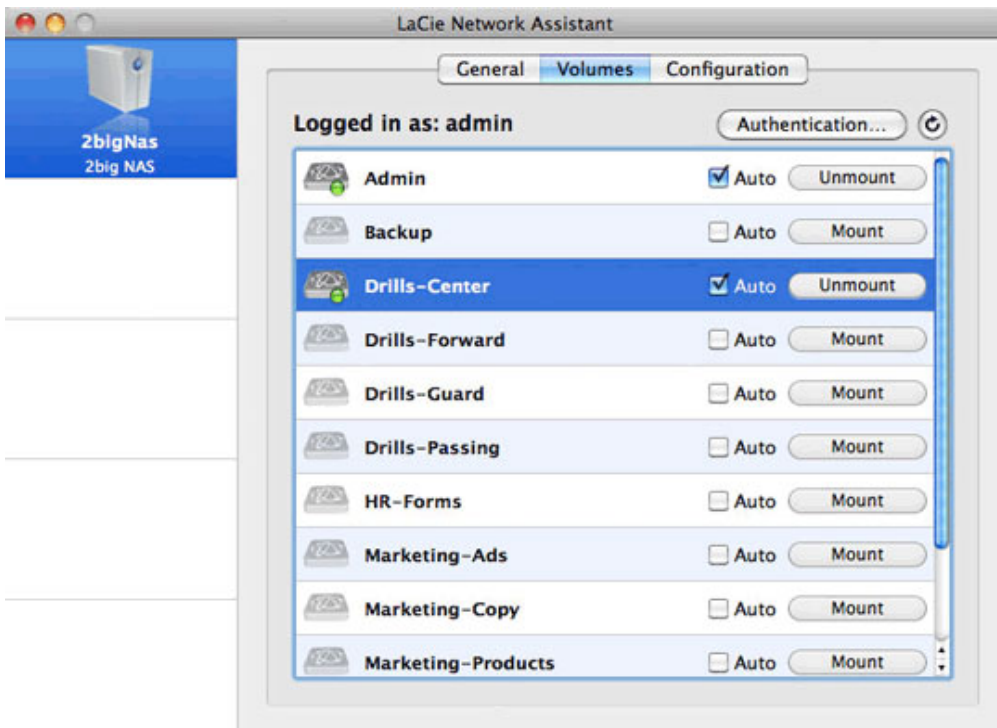

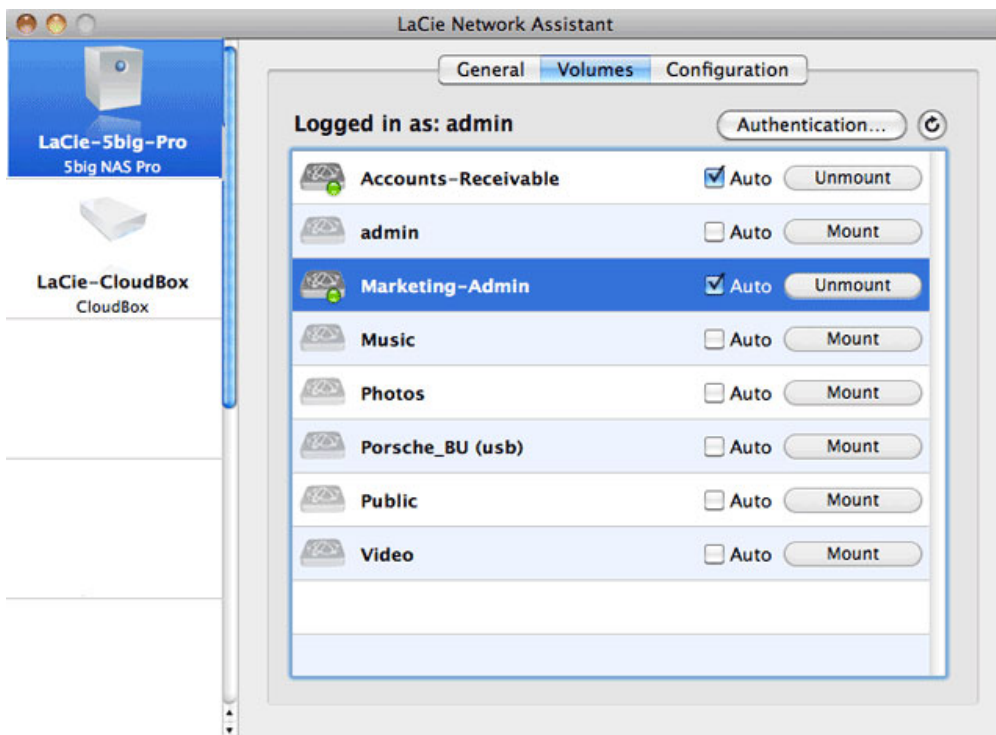

8. **Windows users:** The share will mount in **Computer/My Computer** automatically when the computer detects it on the network.
- Mac users:** The share icon will appear in your Finder automatically when the computer detects it on the network.

# SHARES: ACCESS AND TRANSFER FILES

## ABOUT DEFAULT SHARES

A *share* is a network volume that you can configure to store and share data. Your LaCie NAS has two shares by default: **admin** and **Public**. Following the initial login, the share *admin* will change to the name used by the administrator. For example, if the administrator changes the default login “admin” to “John”, the share *admin* will become *John*.

The following table sums up the differences between them:

Name	Accessibility	Login	Availability
admin	Private, accessible only to admin by default	Password-protected (user password)	Computers on the network and remote access (must be enabled)
Public	Public, accessible to any user on the network	None	Computers on the network and remote access (must be enabled)

It is also possible to create new shares and/or to delete the default shares. See [Shares](#) for details.

## ACCESS SHARES

You have several options for accessing shares on your LaCie NAS.

### Option 1: LaCie Network Assistant - quick share access

Use LaCie Network Assistant for quick access to public shares. See [Quick Access](#) for details.

### Option 2: LaCie Network Assistant - authenticate for private shares

Use LaCie Network Assistant to enter your username and password. See [Authenticate Private Shares](#) for details.

### Option 3: Operating System

Use your operating system to open your LaCie NAS's shares.

#### Windows

In an Explorer window address field, type \\[**machine name**] or \\[**IP address**] and choose **Go**. Alternatively,

from the Start menu, select **Run** then type `\\[machine name]` or `\\[IP address]`. Choose **OK**.

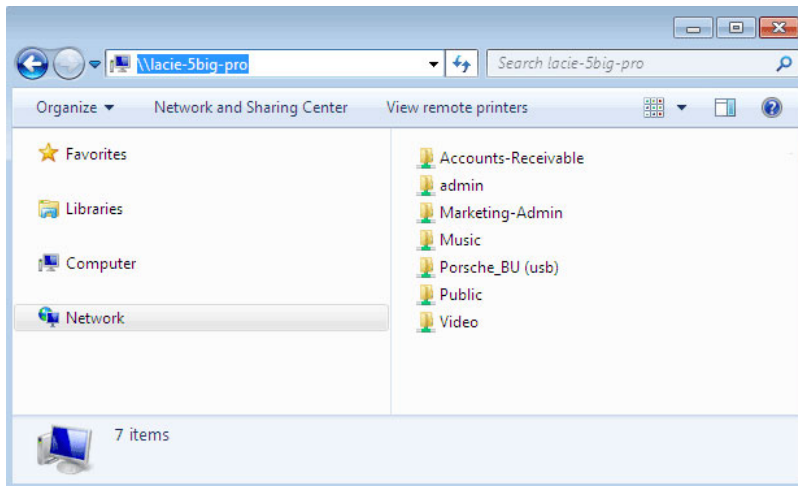

### *Windows Vista, Windows 7, and Windows 8*

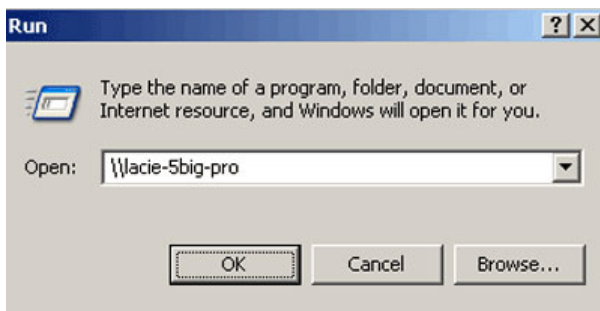

### *Windows XP*



## Mac

1. From the Finder, navigate to **Go > Connect to Server**.
2. In the dialogue window, type one of the following:  
**afp://[machine name].local**  
**smb://[machine name].local**  
**afp://[IP address]**  
**smb://[IP address]**

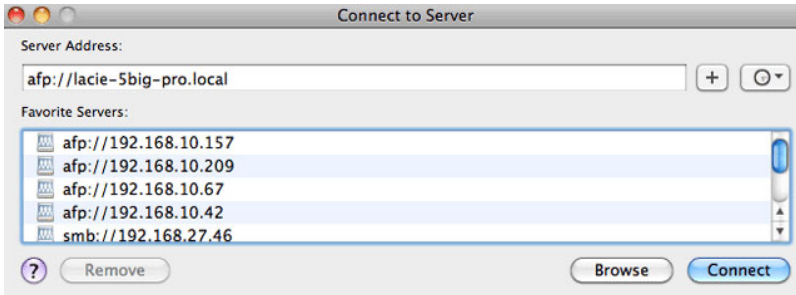

# CREATING SHORTCUTS TO SHARES

Once you successfully set up your LaCie NAS, you can create shortcuts so you can quickly access stored files. You can do this by using your operating system or LaCie Network Assistant.

## CREATE SHORTCUT USING LACIE NETWORK ASSISTANT

LaCie Network Assistant can be configured to automatically mount shares on your computer, which allows you quick access to the files they store. See [Auto-Mount](#) for details.

## CREATE A SHORTCUT USING THE OPERATING SYSTEM

### Windows XP, Vista, and Windows 7

1. From an Explorer window in Windows XP, select **Tools > Map Network Drive**. For Windows Vista and Windows 7, open an Explorer window, navigate to **Computer**, and choose **Map Network Drive**.

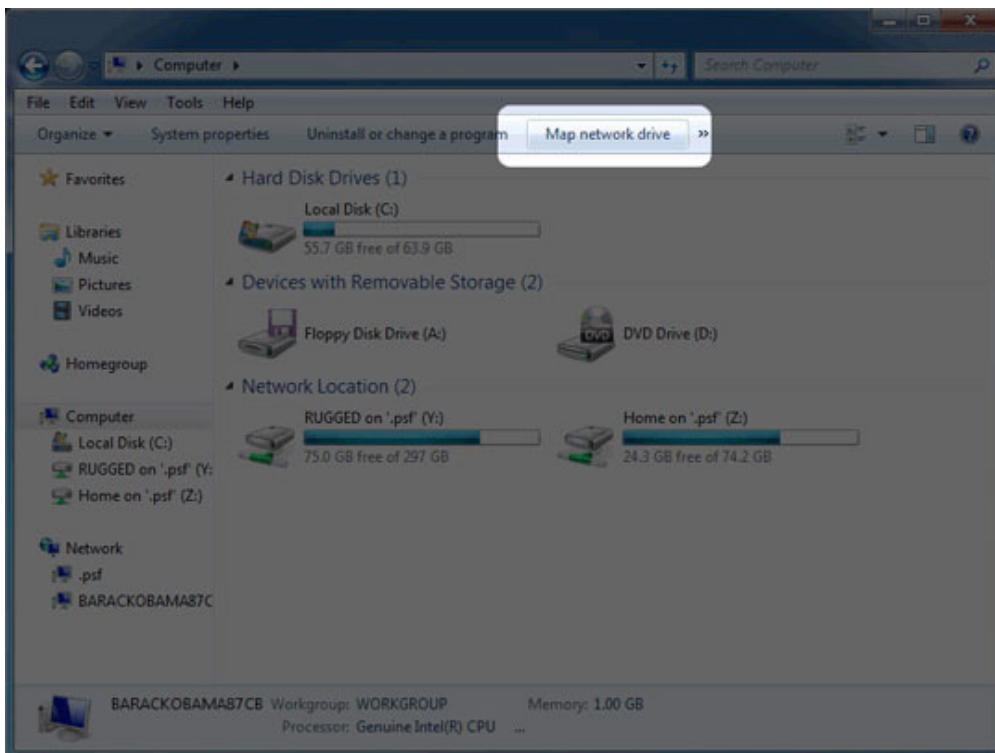

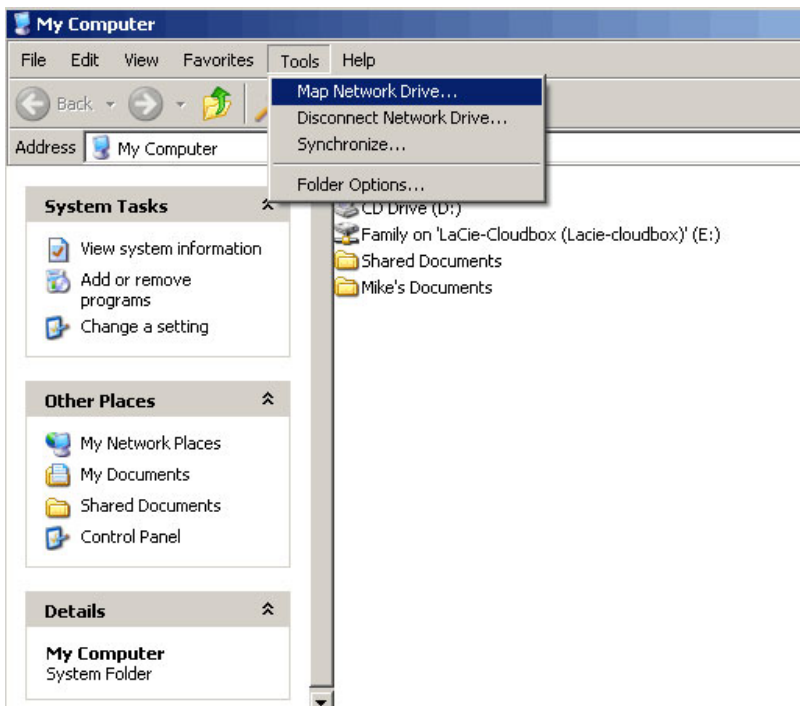

2. Browse to and select the share you wish to auto mount.
3. Windows will offer the option to mount the share each time you log on to the computer.
4. Repeat steps 1-3 for other shares.

## Mac

1. Open a new Finder window. On the left of the window, navigate to **Shared > [machine name] > [share]**. If prompted, type in your username and password and click **Connect**.
2. Repeat step 1 for each share.
3. To mount the share automatically each time you log on to you computer:
  1. From the Apple icon in the menu bar, select **System Preferences > Accounts > Login Items**.
  2. Choose the "+" sign to add a new item to the list and browse for the share. Please note that the shares must be mounted in order to add them to the list.

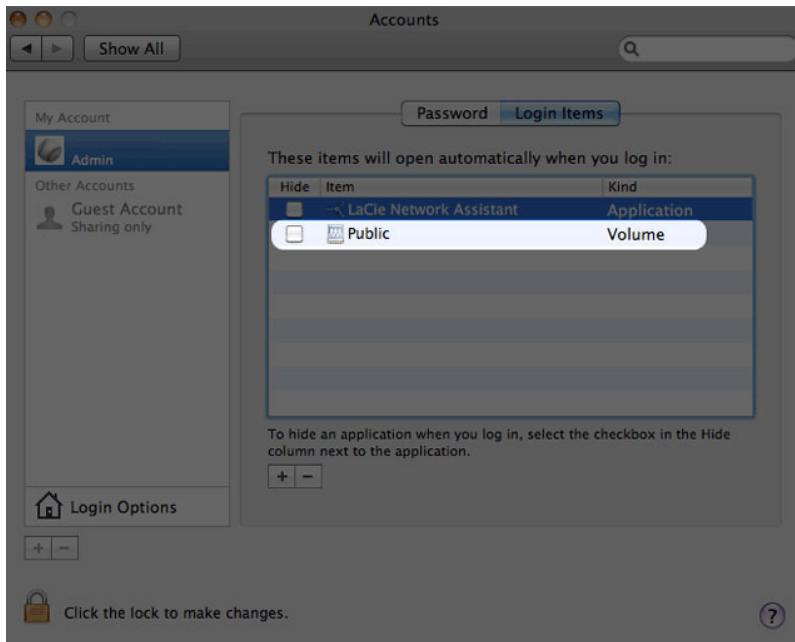

When you log on to the Mac OS, the share(s) will automatically mount on your desktop. If the shares do not mount, check your Finder preferences to confirm that the system will display connected servers on your desktop.

# BACKUP: LACIE NAS AND PC/MAC

## BACK UP YOUR LACIE NAS

See [Backup](#) for a complete explanation on how to automate backups of data stored on your LaCie NAS. You can back up your data to:

- Direct-attached storage (DAS)
- Another LaCie NAS or rsync-compatible server on your local network
- Another LaCie NAS or rsync-compatible server on a remote/offsite network

**Important info on NAS backup:** It is recommended that all users back up data to DAS or another NAS as further protection against disk failure or secondary points of failure (e.g. hardware, network, etc.) See [Backup Jobs](#) for details.

## BACK UP YOUR COMPUTER(S)

Your LaCie NAS is fully compatible with popular backup solutions such as:

- Windows Backup and Restore® and Genie Timeline® (Windows)
- Time Machine® and Intego Backup (Mac)

Professional versions of Genie Timeline and Intego Backup are available on the included Utilities CD-ROM with software.

A share on your LaCie NAS can be set as a backup target for these and other backup software. Make certain that the user has access to the target share meant for his computer. Additionally, deleting a share that is used as a backup target will delete all associated computer backups.

**Note on Time Machine:** Time Machine must be enabled on your LaCie NAS before it can be used as backup software. Go to **Dashboard > General Settings > Application Services** to review the Time Machine service. See [General Settings](#) for details on services.

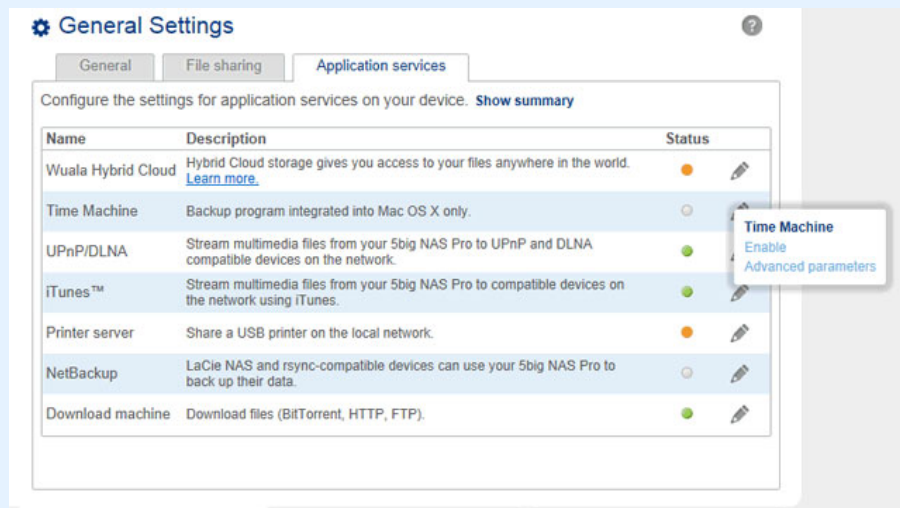

# MEDIA (UPNP/DLNA) SERVERS

You can configure your LaCie NAS to share files (read-only) with UPnP/DLNA devices connected to the same network. Follow these steps:

1. Make sure your LaCie NAS is connected to your network as described in [Connect to the Network](#).
2. Enable the UPnP/DLNA service from the **Dashboard > General Settings > Application Services** tab (see [General Settings](#)).
3. Now you will be able to play files located on your NAS's share onto any other UPnP/DLNA-certified player/adaptor that is connected to your network (e.g. Xbox 360, PlayStation 3, mobile devices that support DLNA, etc.).

## REINDEX THE MEDIA SERVER

To take an inventory of available multimedia files, you can Reindex your LaCie NAS and all connected desktop-attached storage (DAS).

1. If applicable, make certain that your DAS are connected to your LaCie NAS.
2. Confirm that **UPnP/DLNA** is enabled at **Dashboard > General Settings > Application services** (see [General Settings](#)).
3. Select the configuration icon (pencil) to the far right of the **UPnP/DLNA** row and choose **Reindex**.

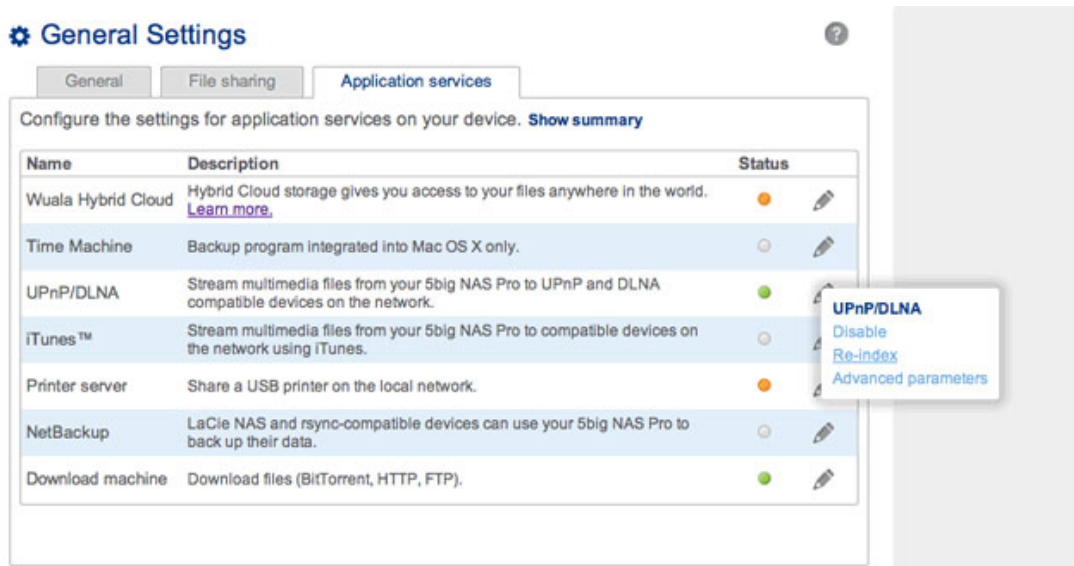

Start a Reindex as described above if files seem missing on your multimedia share(s) or connected devices.

The time for indexing to complete depends upon the total capacity of your storage and the size of your multimedia library. If you have created many shares on your NAS, reindexing can tax the CPU's resources. Before starting the Reindex, consider shutting off multimedia support for shares that do not store media files. See [General Settings](#) and [Shares](#) for further information on how to manage services.

# ITUNES

Your LaCie NAS can act as an iTunes Music server. Simply copy your iTunes library to a share on your LaCie NAS and audio files will be available to compatible devices on the network. For easy access on the entire network, use a share with public access. To limit access to an iTunes library, use a private share with LaCie Network Assistant's **Authentication** (see [Authenticate Private Shares](#)).

To turn on network sharing, follow the steps below for your version of iTunes.

## iTunes 11

1. Make sure your LaCie NAS is connected to your network as described in [Connect to the Network](#).
2. Enable the iTunes service from **Dashboard > General Settings > Application Services** (see [General Settings](#)).
3. To review the iTunes library on the LaCie NAS, launch iTunes on the computer and select the pulldown menu on the left.

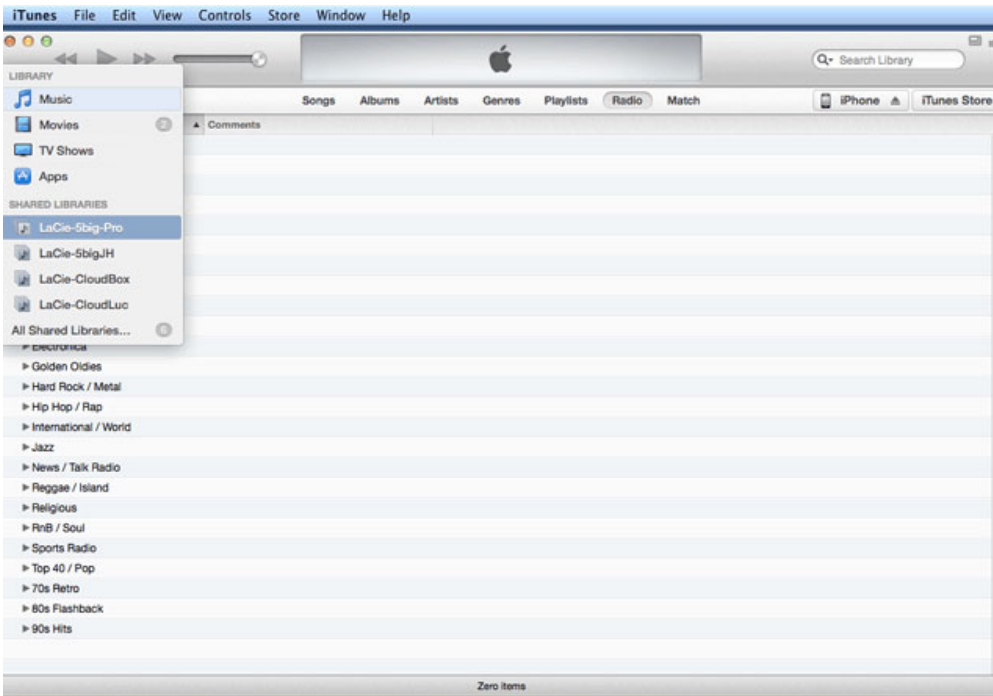

**Technical note:** The iTunes Server Service supports the following file types: .mp3, .wav, .aac, .pls, and .m3u.

Computers with access rights to the iTunes library share can play its audio files. However, sharing must be enabled in the iTunes application for iOS devices. See the steps below:

1. Mount the share with the iTunes library
2. Launch iTunes
3. Enable sharing in iTunes Preferences

The audio files should be available on the iOS device in **Shared**.



# WINDOWS MEDIA PLAYER

Once configured, Windows Media Player (WMP) can play files located on the LaCie NAS through the network connection. Follow these steps:

1. Make sure your LaCie NAS is connected to your network as described in [Connect to the Network](#).
2. Enable the UPnP/DLNA service from **Dashboard > General Settings > Application Services** (see [General Settings](#)).
3. In WMP, choose **Organize > Manage Libraries > Music** (or **Video** or **Pictures**).

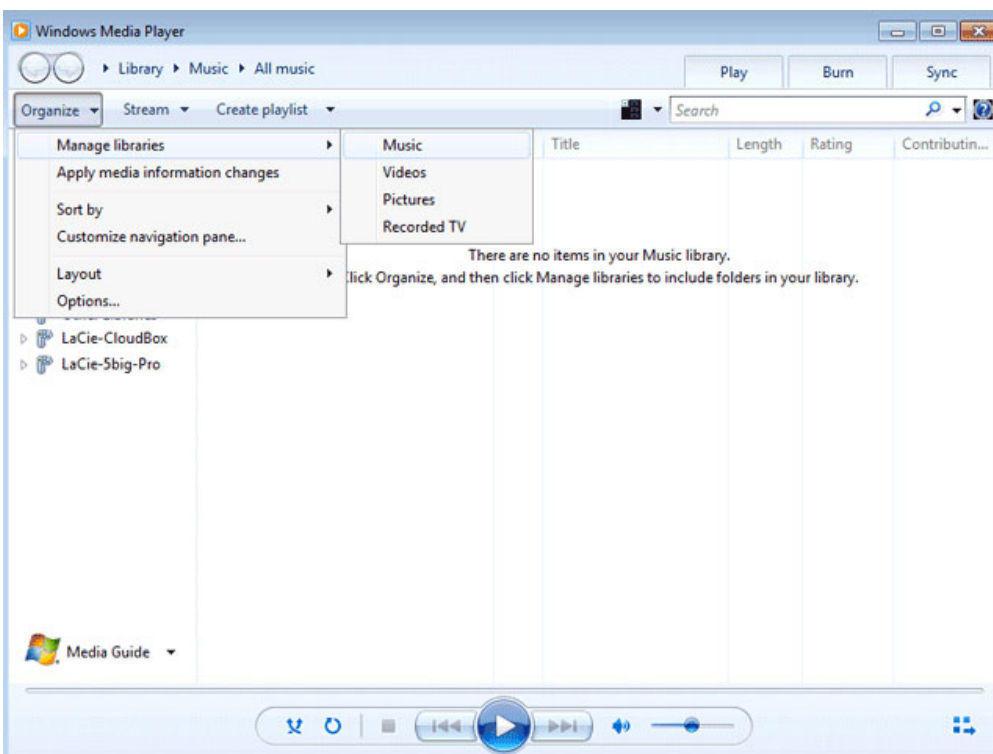
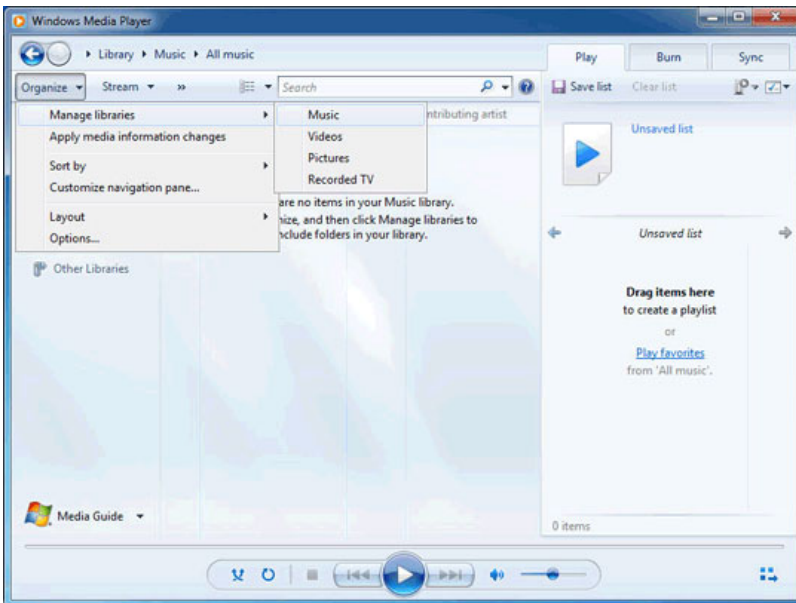

4. In the dialogue window, choose **Add**, select your LaCie NAS's machine name under the Network section, and click **Include Folder**.

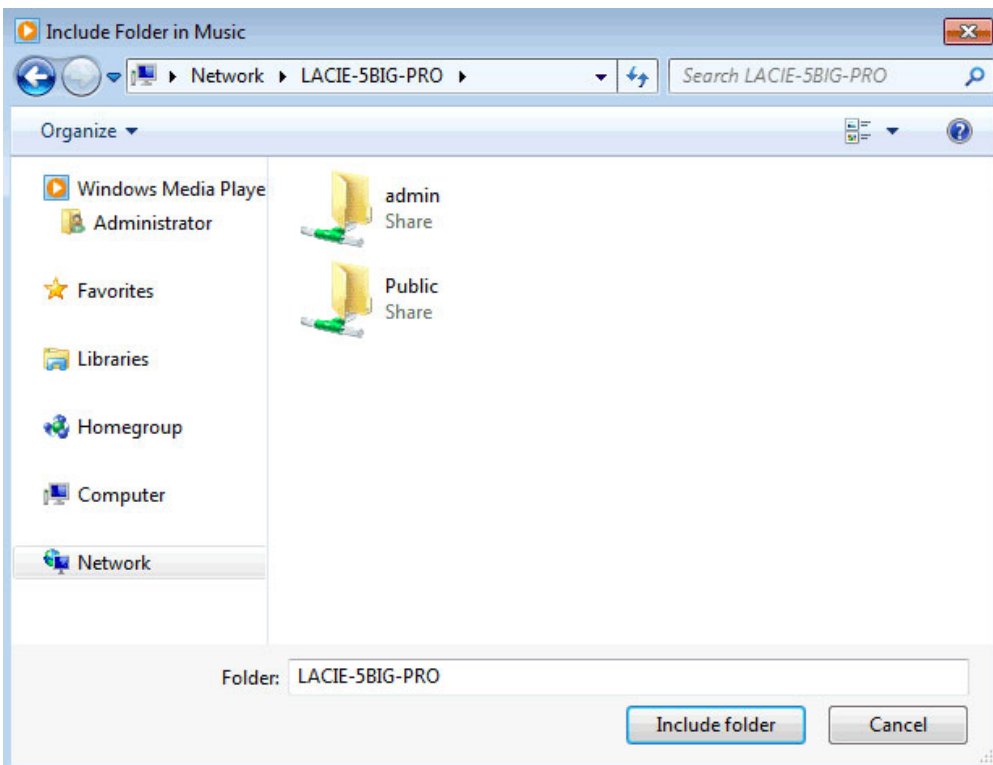
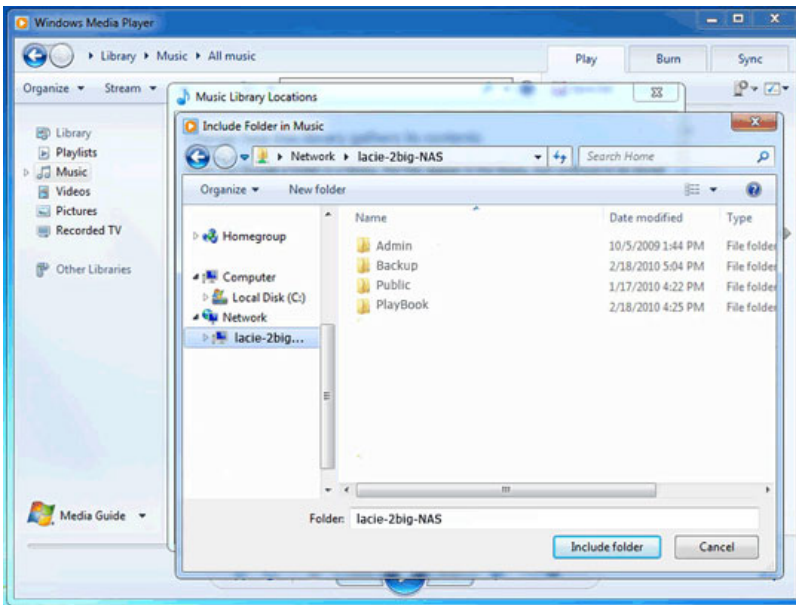

5. WMP will begin indexing the media files. Once completed, they will appear in the WMP library.

# REMOTE ACCESS: LACIE MYNAS

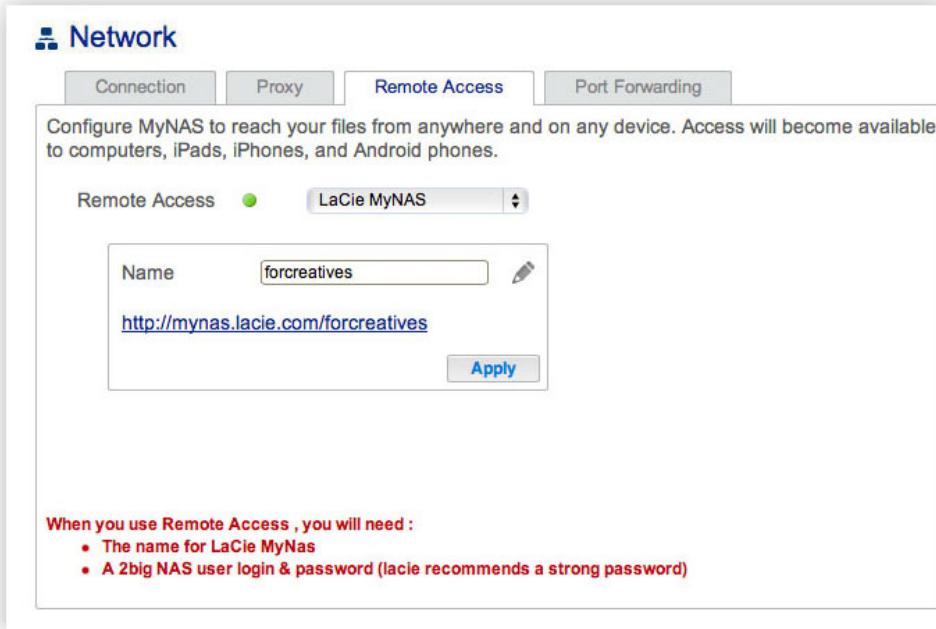

Remote access to your LaCie NAS is available using:

- LaCie MyNAS
- FTP (see [Accessing Shares via FTP](#))

LaCie MyNAS gives users remote access to the Dashboard, including the [File Browser](#) to upload and download files via the internet.

Follow the directions below to configuring LaCie MyNAS.

## SET UP REMOTE ACCESS

For a video demonstration, see [here \(youtube\)](#).

**Important info:** In order to prevent unauthorized access, it is critical to protect each of the user and administrator accounts registered to your LaCie NAS with a strong password BEFORE setting up remote access. Since LaCie MyNAS lets you access your data with a simple URL, malicious users could guess the URL and access the LaCie NAS's files unless each user is protected by a strong password.

1. Navigate to **Dashboard > Network > Remote Connection** tab.
2. In the **Remote Access** drop-down menu, choose **LaCie MyNAS**.
3. Type a name for your LaCie NAS in the **Name** field.
4. Click **Apply**. The Dashboard will query the mynas.lacie.com server to see if the name you chose is available. If so, you will receive a message confirming the connection.

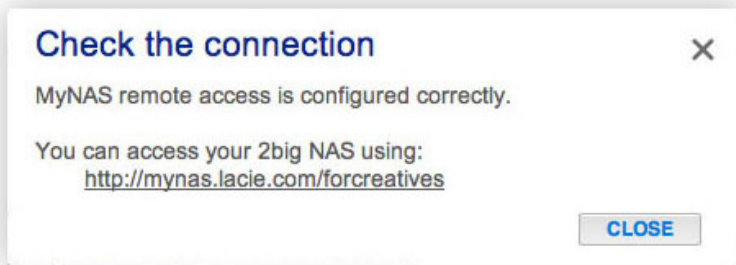

If your name is already chosen, type a new one and click **Apply** until you find an available name.

## FAILED CONNECTION

If you receive an error that your LaCie NAS is unable to connect to the internet:

- You may require a proxy server to access the internet. Please contact your network administrator or internet provider then review [Network](#) for further instructions on how to add your proxy server's address.
- You may need to configure port forwarding on your router. See the steps below.

If the issue is related to your router, you will need to access its administration page in order to forward a port (by default, 8080), which will create a path from your LaCie NAS to the internet. Refer to your router's documentation for details.

1. Navigate to the **Dashboard > Network > Remote Access** tab.
2. Next to the **Name** field, click the configuration icon, then select **Advanced settings**.

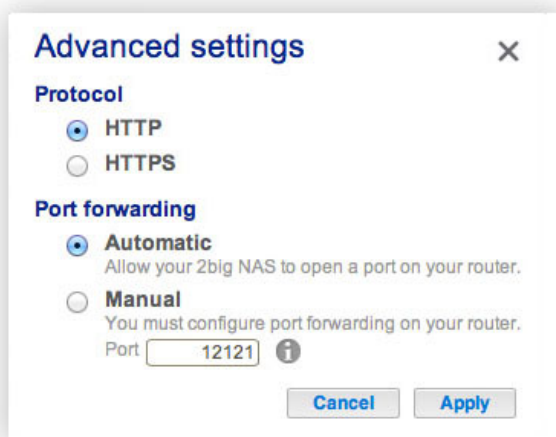

(If you do not see the configuration icon next to the **Name** field, first type a name and then click **Apply**, and the icon will appear.)

3. In the dialogue window that appears, click **Manual**.
4. Next, identify which port you intend to forward in your router.
5. Click **Apply**.
6. Access your router's administration page in order to forward this port.
7. Retry the remote access connection.

# USING REMOTE ACCESS

Once configured, simply type your LaCie NAS's URL into any browser, anywhere.

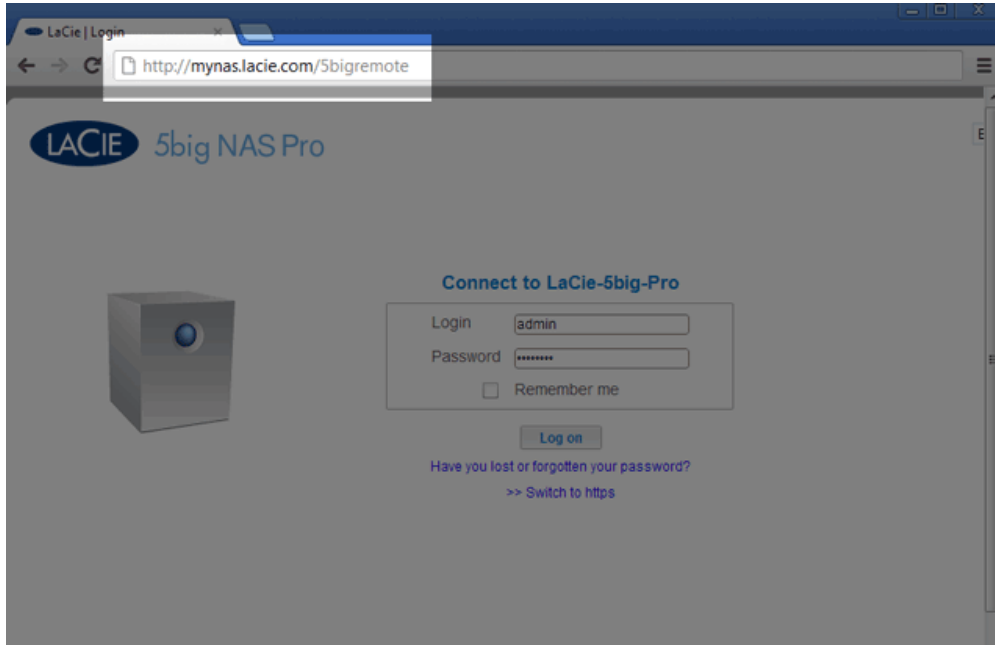

Your URL will be: `mynas.lacie.com/name`

After you input the URL, you will be asked to log in to the Dashboard. Note that this username and password are the credentials created by the administrator in **Dashboard > Users**.

Once logged in, you will be able to access the Dashboard in order to administer your LaCie NAS (if you have administrative privileges) or access the File Browser. The File Browser lets you upload, download, and stream many types of multimedia files such as mp3 (see [File Browser](#)).

# MOBILE DEVICES

LaCie MyNAS is compatible with iOS devices. See the [iOS App Store](#) for details.

## ACCESSING SHARES VIA FTP

FTP (file transfer protocol) is used to transfer files from one computer to another via the local network or the internet. This protocol allows you to exchange files with your colleagues, clients, or business partners securely, as only people with a user account will have access. For a detailed explanation of the benefits of using FTP, see <http://en.wikipedia.org/wiki/FTP>.

The FTP service is disabled by default but you can enable it on the **Dashboard > General Settings** page (see [General Settings](#)).

Once FTP is enabled, your LaCie NAS can be accessed using an internet browser or FTP client software. FTP client software is very helpful if you wish to share, download, and upload data within a dedicated application rather than an internet browser. Examples of FTP client software include [Filezilla](#) and [Cyberduck](#).

## LOCAL FTP ACCESS

To use the FTP service on your local network, enter your LaCie NAS's IP address or device name in the FTP client's address field or in an internet browser's address field. Your LaCie NAS's IP address is available on the **Dashboard > Network** page or [LaCie Network Assistant](#).

### Public Access Folders (non-password protected):

ftp://[IP-address] (For example, ftp://192.168.10.149)

ftp://[machine name]/ (For example, ftp://lacie-5big-pro/ or ftp://lacie-5big-pro.local/)

### Private Access Folders (password protected):

When following the directions below, usernames and passwords can vary depending upon the user. For example, the administrator's username and password are not the same as another user's name and password.

ftp://[username:password@IP-address] (For example, ftp://admin:adminpassword@192.168.10.149)

ftp://[username:password@machine name]/ (For example, ftp://admin:adminpassword@lacie-5big-pro/ or ftp://admin:adminpassword@lacie-5big-pro.local/)

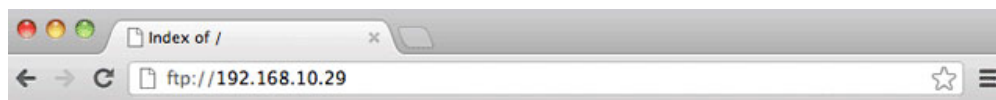

## Index of /

Name	Size	Date Modified
Music/		10/18/12 9:14:00 AM
Photos/		10/18/12 9:14:00 AM
Public/		10/18/12 9:14:00 AM
Video/		10/18/12 9:14:00 AM

*Access files via FTP using an internet browser*

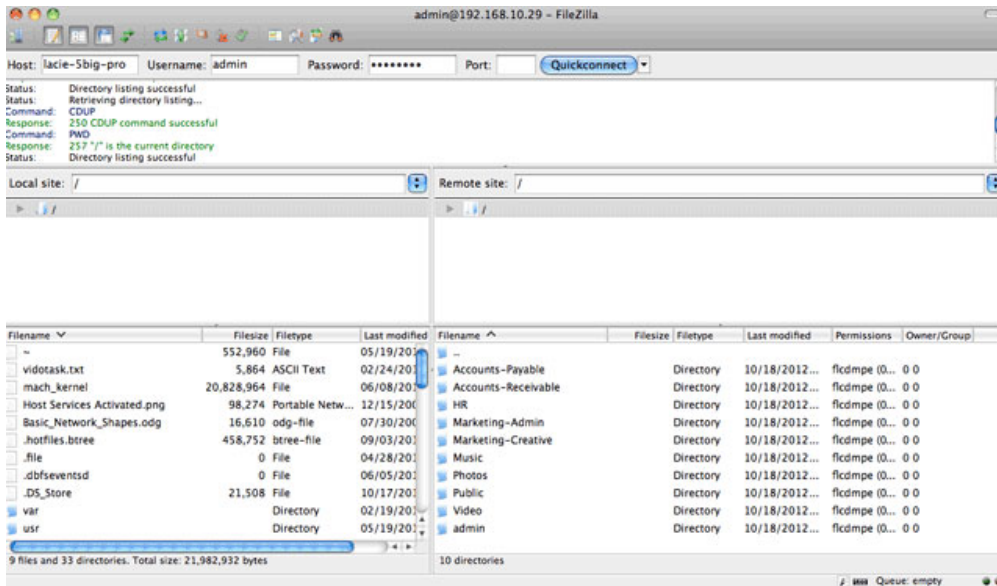

### Access files via third-party FTP applications



## REMOTE FTP ACCESS

You can access and share your LaCie NAS's files from a computer outside of your home network. To gain access using FTP, you will need to know your router's public IP address.

1. From a computer on the same local network as the LaCie NAS, visit this page: <http://www.whatismyip.com/>.
2. Note your public IP address.
3. Launch an internet browser or FTP client software.
4. Within the internet browser or FTP client's address field, type:
  - Public folders only: ftp://[Public IP-address] (For example, ftp://94.10.72.149)
  - Public and private folders: ftp://[username:password@Public IP-address] (For example, ftp://admin:adminpassword@94.10.72.149)

For further information on the public IP address for your router, see your router's user manual or your internet service provider.

## SFTP

SFTP is a secure version of the FTP service. Data is more secure when using SFTP but transfer rates are slower. Similar to FTP, SFTP is disabled by default but you can enable it on the **Dashboard > General Settings** page (see [General Settings](#)).

**Note on NetBackup Server and SFTP:** Activating NetBackup server will disable SFTP (see [Backup](#) for details).

## ACCESSING SHARES VIA NFS

Network File System (NFS) is a distributed file system protocol allowing a system to share directories and files with others over a network. Like SMB, NFS grants file-level access to users and programs.

NFS is widely distributed to host VMWare datastores or share network folders in a Linux/UNIX environment.

When enabling NFS service on a share, it can be accessed with the following path:

NAS\_NAME\_OR\_IP\_ADDRESS:/shares/SHARE\_NAME

The NFS protocol is not active by default. To activate it, go to **Dashboard > General Settings > File Sharing** (see [General Settings](#)). Select the configuration icon (pencil) to choose **Enable**.

**Important info:** All NFS shares are public and available to everyone on the network. See [Shares: Access and Transfer Files](#) for details on public and private shares.

## WAKE ON LAN (WOL)

Your LaCie NAS can conserve energy by entering deep sleep mode. Use the Dashboard to schedule deep sleep mode when no one accesses the LaCie NAS and wake it up when your office is ready to work. See [Eco Management](#) for more information on deep sleep mode.

You can also use LaCie Network Assistant to wake your LaCie NAS from deep sleep mode. This feature is called Wake on LAN (WOL). Follow the steps below:

1. Right click the LaCie Network Assistant icon in your system tray (Windows) or choose it in the menu bar (Mac).
2. Select **Wake Up a Device...**

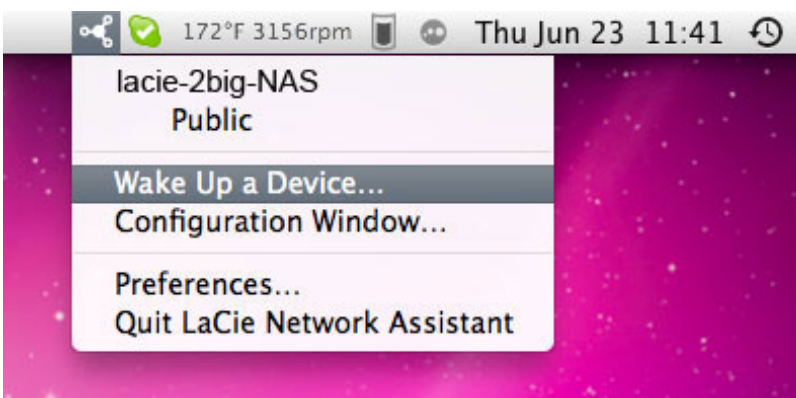
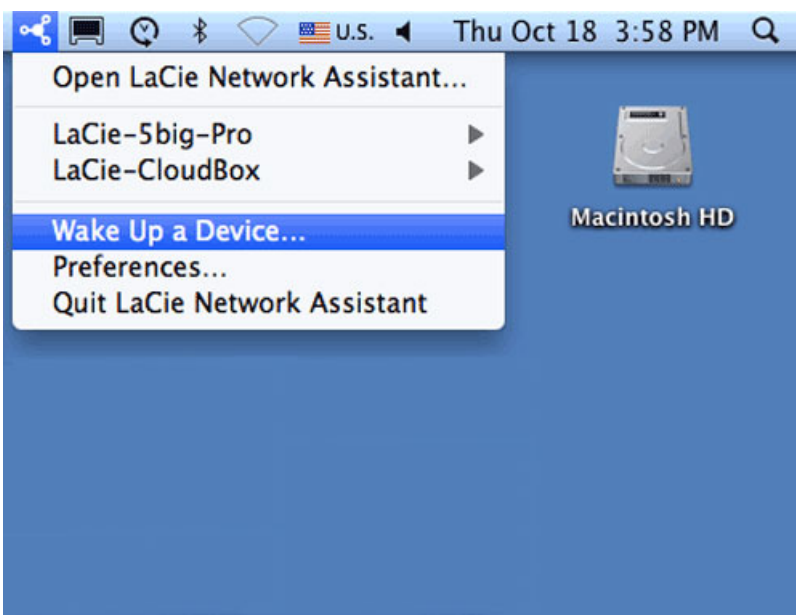

3. Choose the LaCie NAS product you wish to wake up from the pull-down menu.

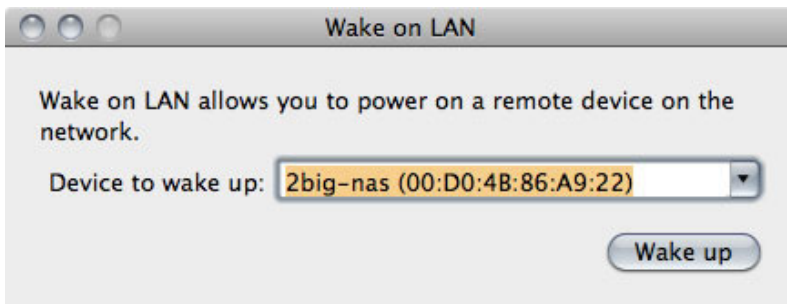
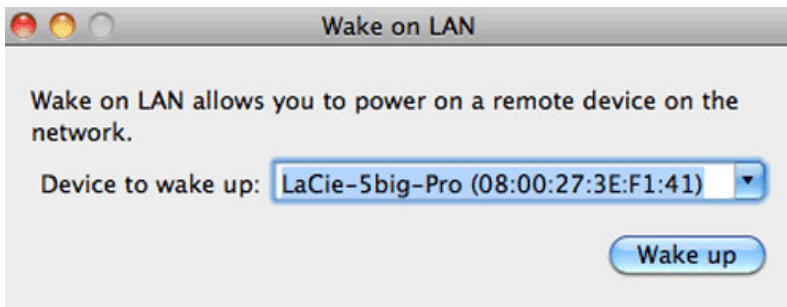

4. Choose **Wake up**.

**Note on the MAC address list:** The list will be empty the first time you launch **Wake Up a Device**. Enter the device's MAC address in the field to select **Wake up**. Once entered, LaCie Network Assistant will keep the device's MAC address on the list.

# NAS OS ADMINISTRATION

All LaCie NAS feature an easy-to-use browser-based administration tool, called the **Dashboard**. Launch the Dashboard to manage storage, users, shares, and much more.

## ACCESS THE DASHBOARD

There are two ways to access the Dashboard: LaCie Network Assistant and an internet browser.

### Access the Dashboard: LaCie Network Assistant

See [LaCie Network Assistant](#) for instructions on software installation.

1. **Windows:** Right-click on the LaCie Network Assistant icon in the system tray (Windows users). **Mac:** Choose the LaCie Network Assistant icon in the menu bar.

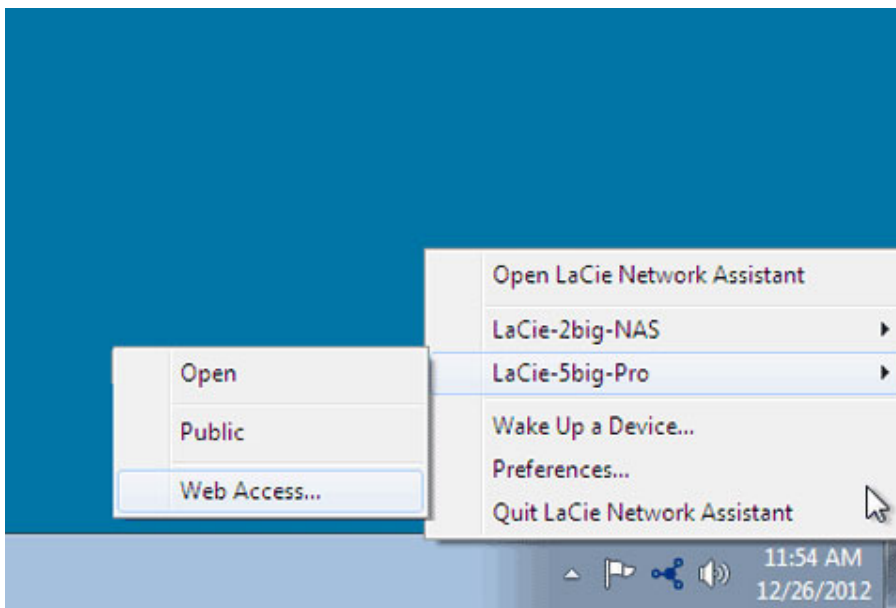

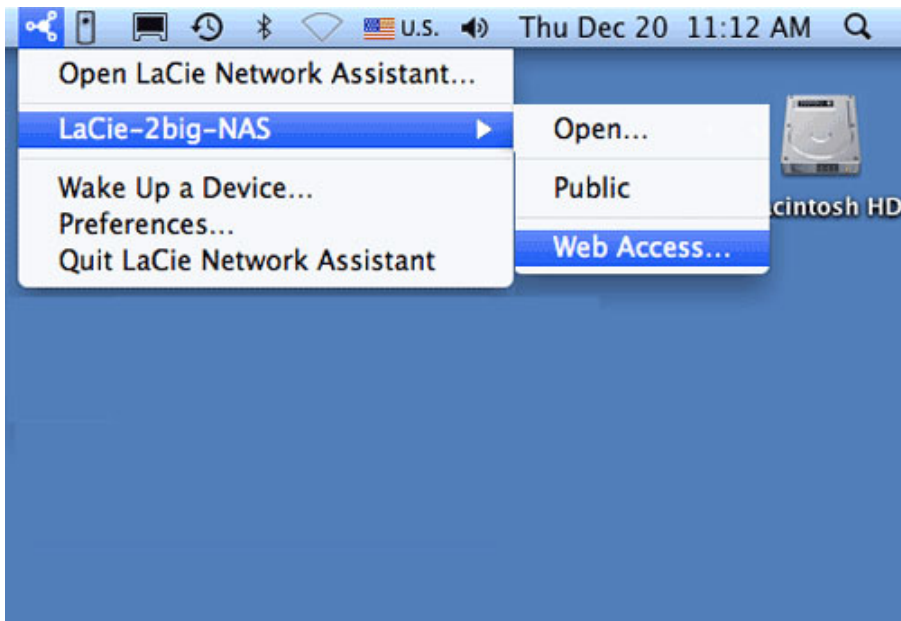

2. Select **[machine name] > Web Access**.
3. The login page will open in a new browser window or tab. If your browser is not open, LaCie Network Assistant will open it for you.

## Access the Dashboard: Internet browser

1. Launch your preferred internet browser and type the default address for the LaCie NAS:
  - Windows workstations (no Bonjour) - <http://lacie-2big-nas> or <http://lacie-5big-pro>
  - Mac OS X and Windows workstations running Bonjour - <http://lacie-2big-nas.local> or <http://lacie-5big-pro.local>.

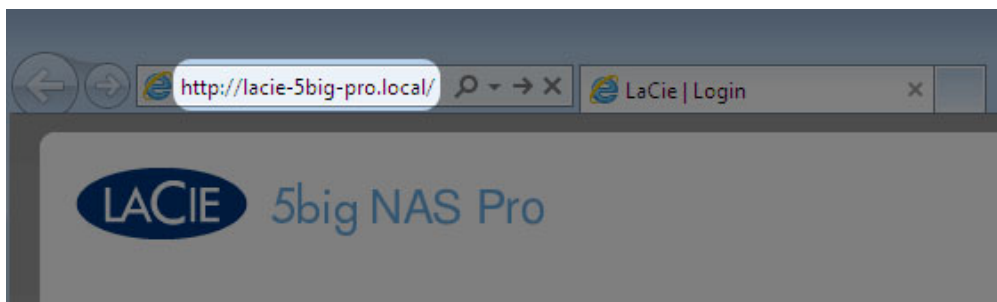

You can also type your LaCie NAS's IP address in the browser's URL (web address) field. For example: **http://[IP-address]**.

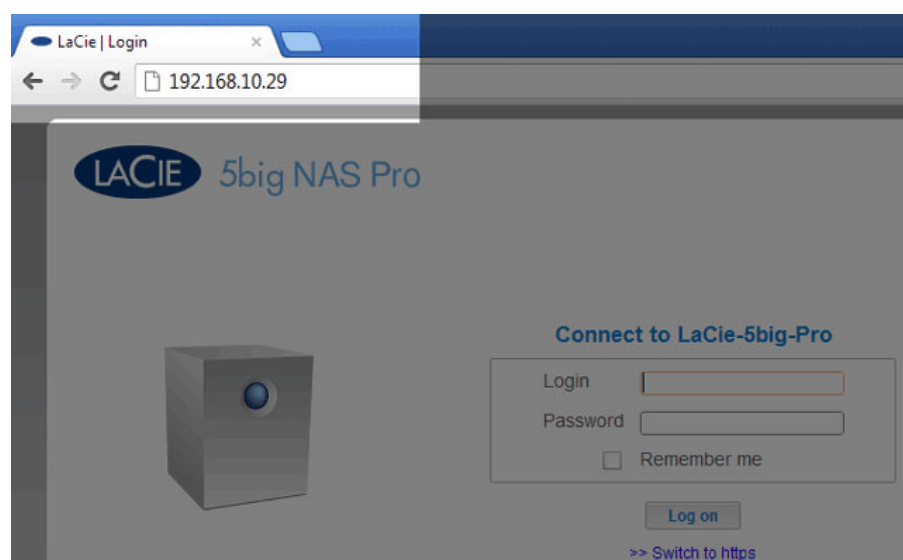

The IP address may be found in LaCie Network Assistant (see [Find the IP Address](#)).



# LOG IN

The first time you access the Dashboard, complete the *Authentication* and *Timezone* fields. (The password should be from 4-20 alphanumeric characters and symbols, and the username should be from 1-20 alphanumeric characters. Consider using a strong password that is difficult for others to guess.)



1. Update      2. Settings      3. Share recovery

**Authentication**

Product name: LaCie-2big-NAS  
To identify your 2big NAS on your local network.

Administrator login: admin

Password: [masked]

Confirm your password: [masked] ✓

**Timezone**

**Suggestions**

- (GMT+01:00) Amsterdam, Berlin, Rome, Stockholm, Vienna
- (GMT+01:00) Belgrade, Bratislava, Budapest, Prague
- (GMT+01:00) Brussels, Copenhagen, Madrid, Paris**
- (GMT+01:00) Sarajevo, Skopje, Warsaw, Zagreb

**All Time Zones**

- (GMT-12:00) Eniwetok, Kwajalein
- (GMT-11:00) Samoa Standard Time, Midway Is.

Back    Next

In subsequent logins, simply enter your username and password, then choose **Log on**.



English ▼



**Connect to LaCie-2big-NAS**

Login: [input field]

Password: [input field]

Remember me

Log on

>> Switch to https

For added security, choose **Switch to HTTPS** at the Dashboard login.

## Recover a lost password

If a user has forgotten his/her password, it can be recovered if the administrator has:

- Assigned an SMTP server (see [Support](#)).
- Entered an email address for that user (see [Users](#)).

If the above conditions have been met, the administrator and/or user can follow the steps below to recover a password:

1. On the login page, choose **Have you lost or forgotten your password?**.

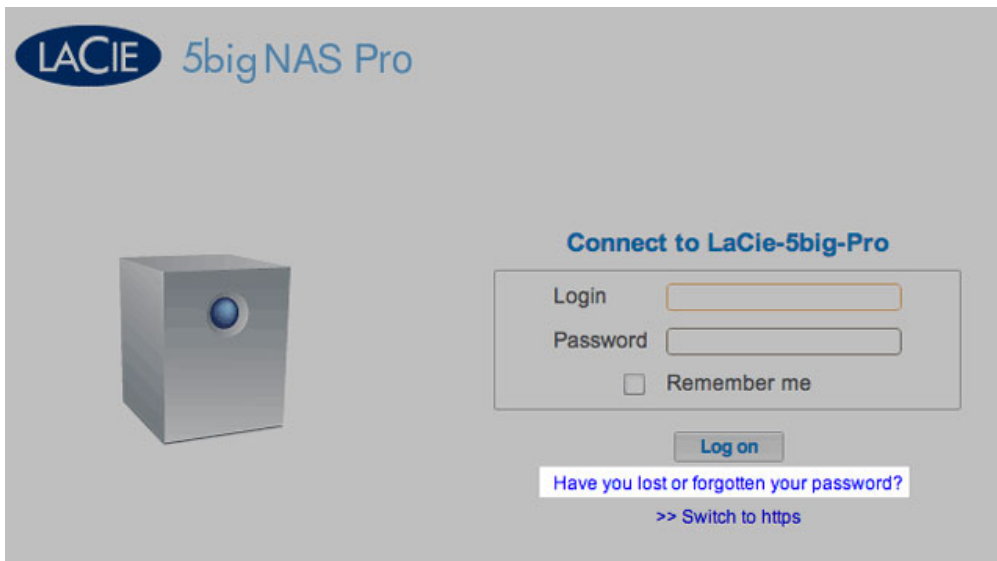

2. On the next page, type the login. Then type the word you see in the image on the right (this ensures that the request is coming from a person) and choose **send**.

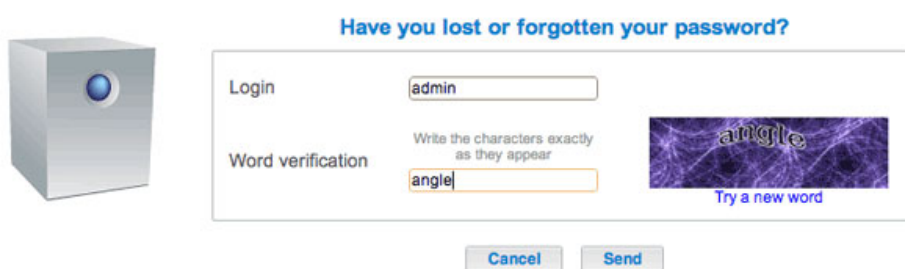

3. The email will arrive in the user's email inbox. In the email, choose the **click here** link.
4. In the **Reinitialize your password** screen, type your login and new password, then choose **Send**.

## Restart, deep sleep mode, and shutdown

To restart or put the LaCie NAS into deep sleep mode, select the power button, then choose between **Restart** and **Deep Sleep mode**. Deep sleep mode must be enabled or the option will not be available (see [Eco Management](#)).

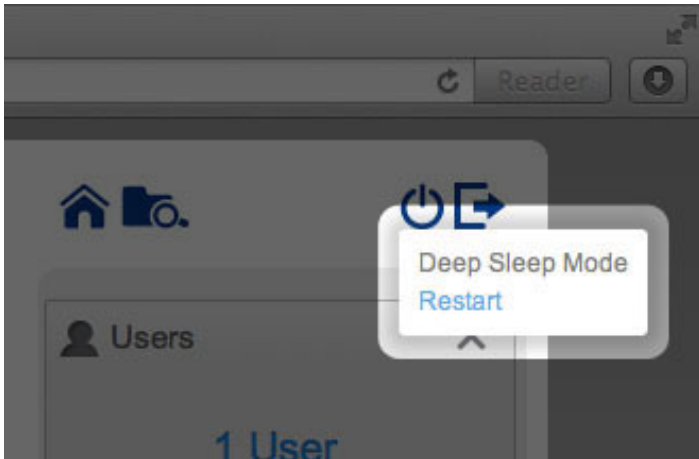

*2big NAS Restart and Deep Sleep Mode*

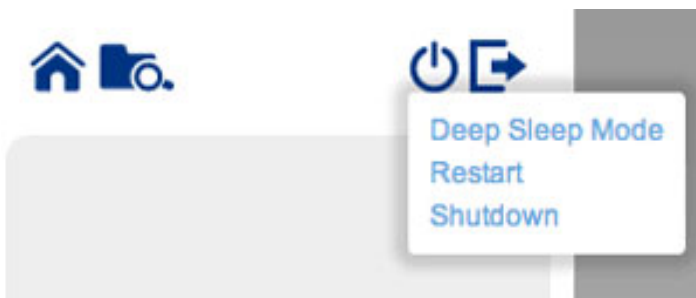

*5big NAS Pro Deep Sleep Mode, Restart, and Shutdown*

The LaCie 5big NAS Pro has the added option to **Shutdown** the device. To shut down the LaCie 2big NAS, use the switch on the back of the device (see [Views of the Product](#)).

**Note:** Shut down your LaCie NAS only when it is not being accessed.

## Log out

To log out of the Dashboard, choose the log out button.

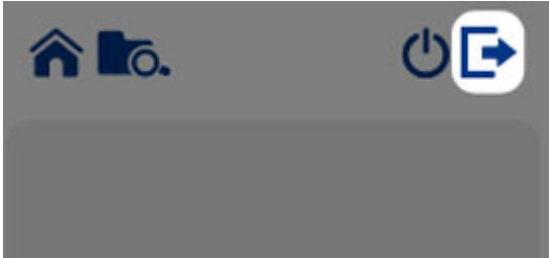

## NAVIGATE THE DASHBOARD

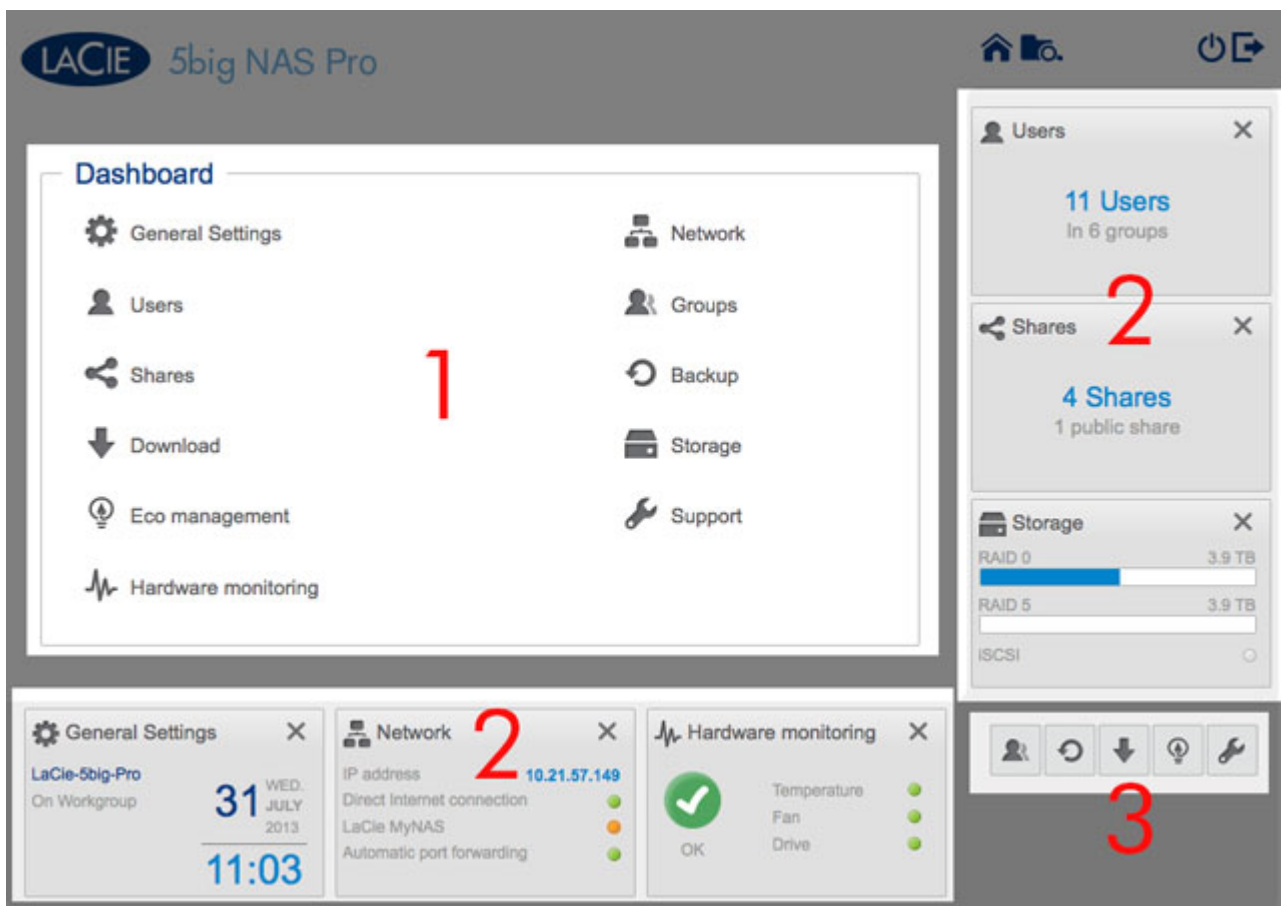

The Dashboard is made up of:

1. The central pane that hosts all management pages
2. Visible widgets, or small boxes that represent the different pages. A visible widget provides a summary of the page's management function. For example, the *Hardware monitoring* shows the health status of the NAS, including the Temperature, Fan, and Drive states.
3. Minimized widgets



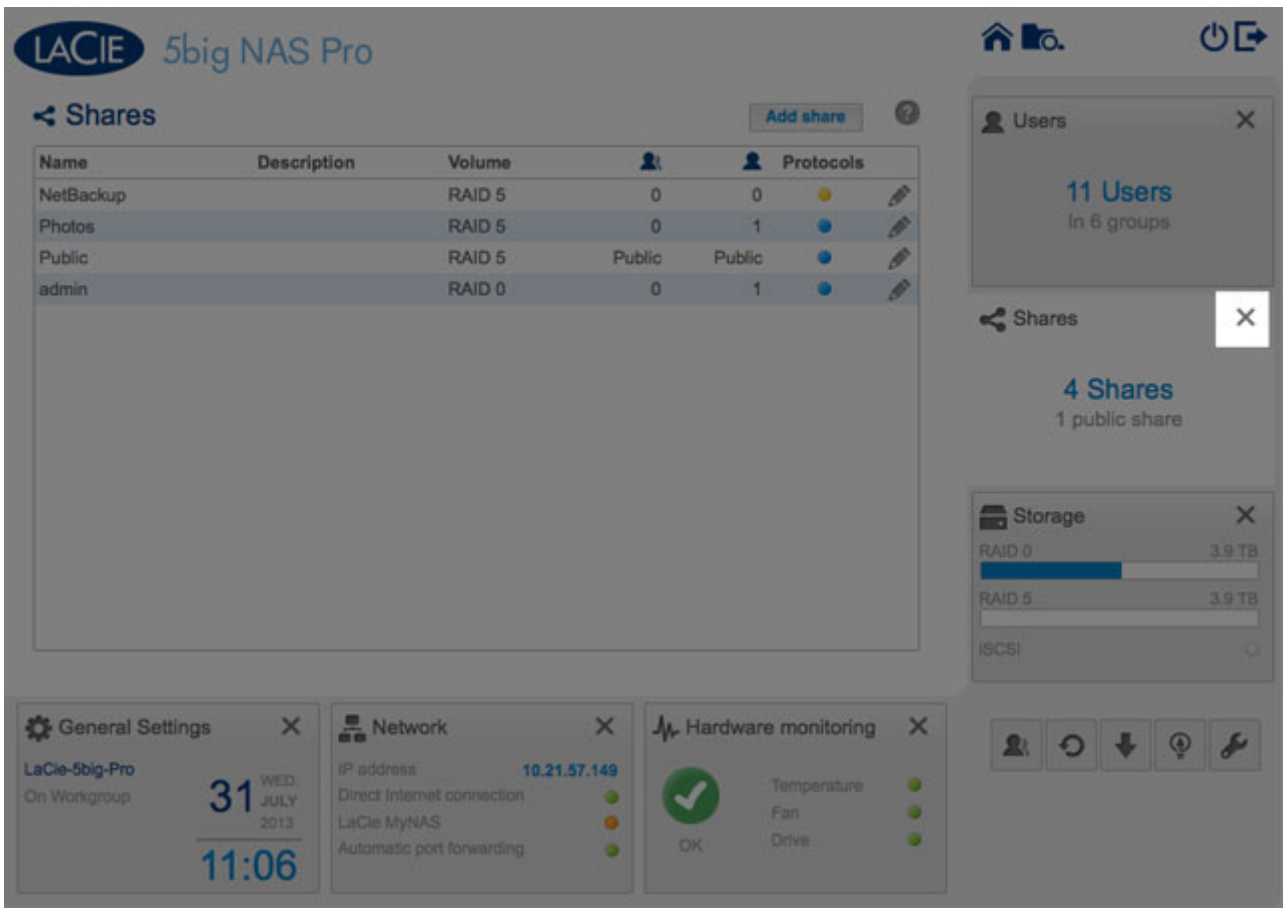

- To **expand a minimized widget**, drag its icon over an expanded widget, or to an open widget space.
- To **rearrange widgets**, drag the minimized widget icon or the expanded widget onto the place of another widget.

# FILE BROWSER

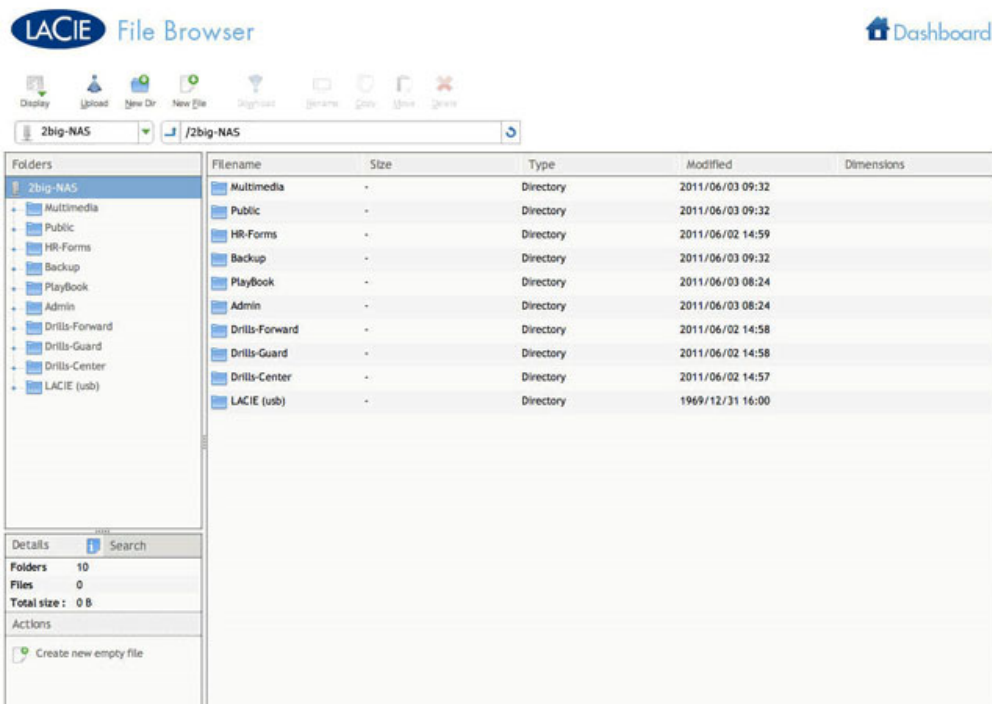

The Dashboard features an interactive File Browser that allows you to manage and transfer files via HTTP. Access the File Browser by choosing its icon in the upper right-hand corner of the Dashboard.



You can use the File Browser to transfer, copy, and delete files, as well as view photos in thumbnails and stream multimedia content such as mp3 files and view photos. It is thus a convenient way to interact with files stored on your external hard drives through the network, whether the connection be through the local network or through the internet (see [Remote Access: LaCie MyNAS](#)).

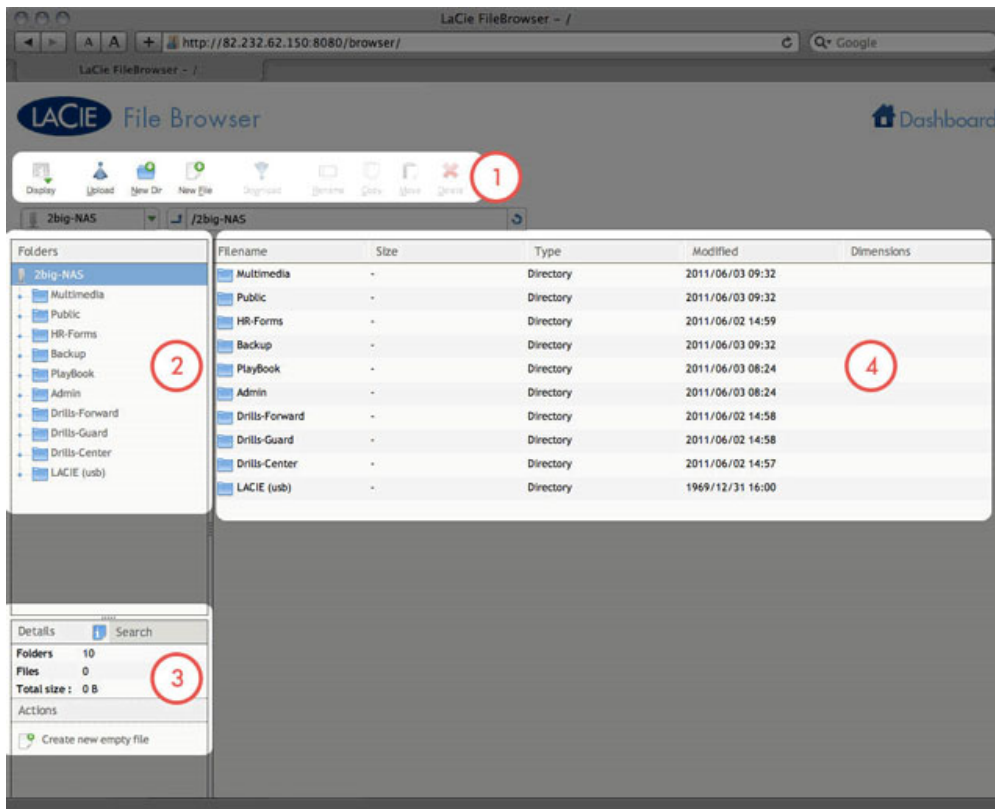

File Browser window:

1. The toolbar allows you to perform a range of functions, such as changing the way files are displayed, creating folders, uploading files, and streaming files.
2. The folder structure on the selected share.
3. The information on a selected file, such as the name, thumbnail, type, dimensions (photos), or duration (videos). You can also search for files.
4. The files within a selected folder. To view the files as thumbnails, choose **Thumbs** in the toolbar.



## OPEN FILES

- **Photo:** Choose the **View** button in the toolbar.

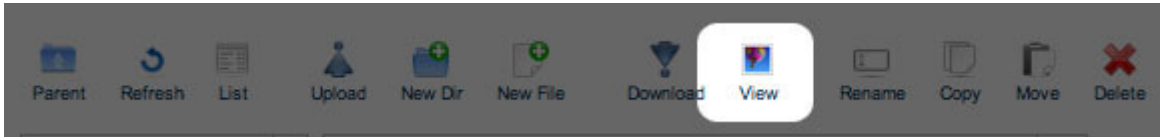

- **Music:** Choose the play button in the **Details** panel (mp3 files only).

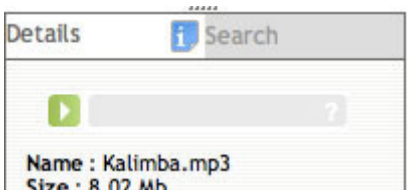

- **TXT files:** Choose the **Edit** button in the toolbar.

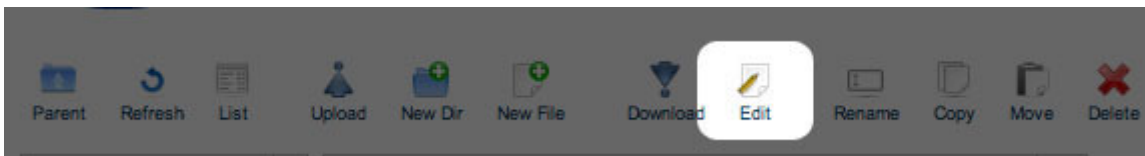

# GENERAL SETTINGS

## GENERAL TAB

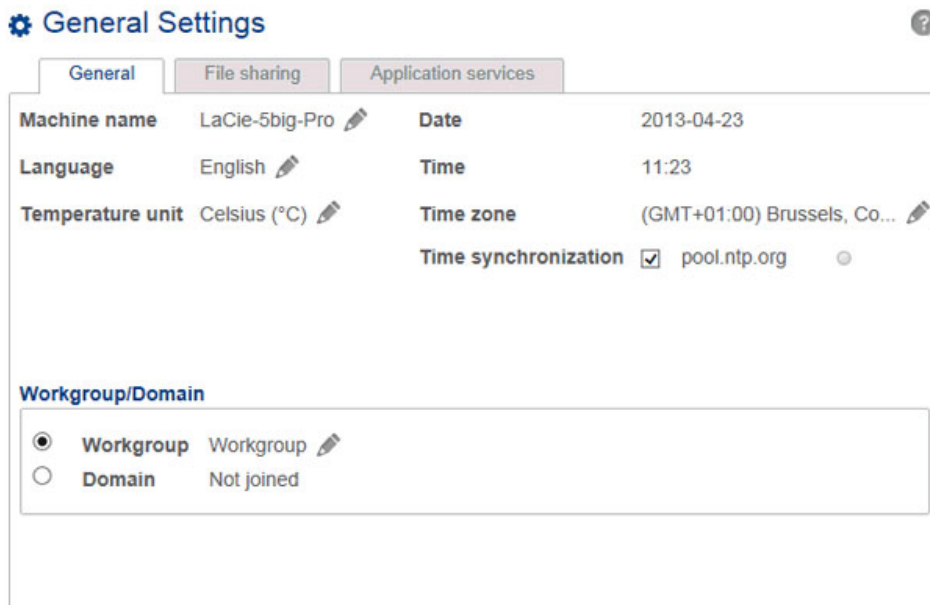

- **Machine Name:** The machine name identifies your LaCie NAS on your network. You can change it from the default by choosing the pencil icon and typing a new one. If a duplicate name exists on the network, alternate names are automatically created to avoid conflicts. For example, a second LaCie 5big NAS Pro on your network will automatically be called *LaCie-5big-P-1*. The machine name is limited to 15 characters and case-sensitive. You must also use alphanumeric characters without spaces or symbols.
- **Date:** The date and time are set automatically if you assign an NTP server (see below). If not, select the pencil icon and choose a day from the calendar.
- **Language:** Choose the pencil icon to change the Dashboard language.
- **Time:** If the time is not set by the NTP server, select the pencil icon and choose the proper time.
- **Temperature unit:** Select the pencil icon to choose **Celsius** or **Fahrenheit**.
- **Time zone:** Select the pencil icon for the listed time zone, then choose your timezone from the drop-down window.
- **Time synchronization:** Sync the time and date with an NTP (network time protocol) server. NTP will automatically adjust the time settings for daylight savings.

## Domain

You LaCie NAS can join a Windows Workgroup or a Windows Active Directory:

- **Workgroup:** Select the radio button for **Workgroup** and choose the pencil icon to type its name (use from 1 to 15 alphanumeric characters).
- **Domain:** Select the radio button for **Domain** if you intend to join a Windows Active Directory (see the next paragraph for instructions on entering your Active Directory credentials). When joining an Active Directory, existing users/passwords in the domain are respected by the LaCie NAS and treated exactly as if they were created in the Dashboard. Once you have joined the Active Directory, domain users may be assigned access to the LaCie NAS's shares.

**Active Domain Troubleshooting:** The information below provides general information on joining and leaving a domain. For additional information, see [Troubleshooting the Active Directory Connection](#).

## Connect to an Active Directory

1. Select the **Domain** radio button.
2. At the prompt, fill in the **Fully-qualified domain name**, **Administrator login**, and **Administrator password**. For more complex network configurations, choose the **Advanced Criteria** arrow and fill in the **Server name** and **Server IP** fields.

### Domain configuration ✕

Machine name LaCie-5big-Pro

Fully-qualified domain name

Administrator login

Administrator password

▼ [Advanced criteria \(optional\)](#)

Server name

Server IP  .  .  .

3. Once connected, you can import users from the domain at [Users](#).

## Synchronize Users/Groups

Except for access rights to shares on the LaCie NAS, users and groups imported from a domain are managed by the domain's administrator. If a user's/group's account has been changed by the domain administrator within the Windows Active Directory server (e.g. password revision, deleted from the domain, etc.), you can update the account on the LaCie NAS by choosing on the button **Synchronize imported users/groups**.

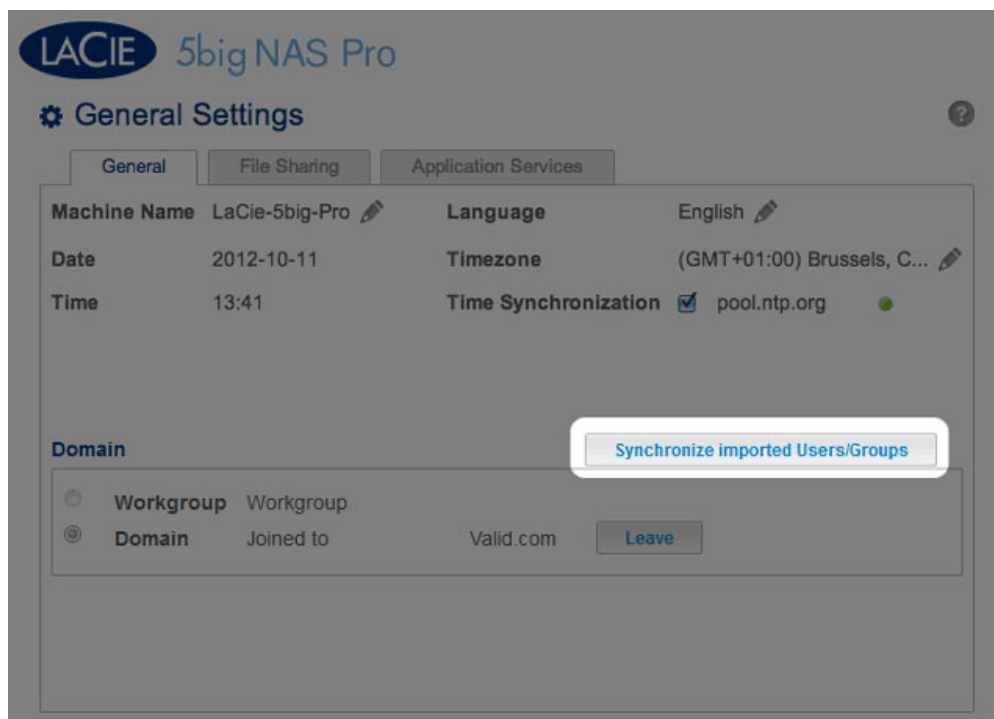

## Leave the domain

To remove the LaCie NAS's connection to a domain:

1. Choose the **Leave** button.

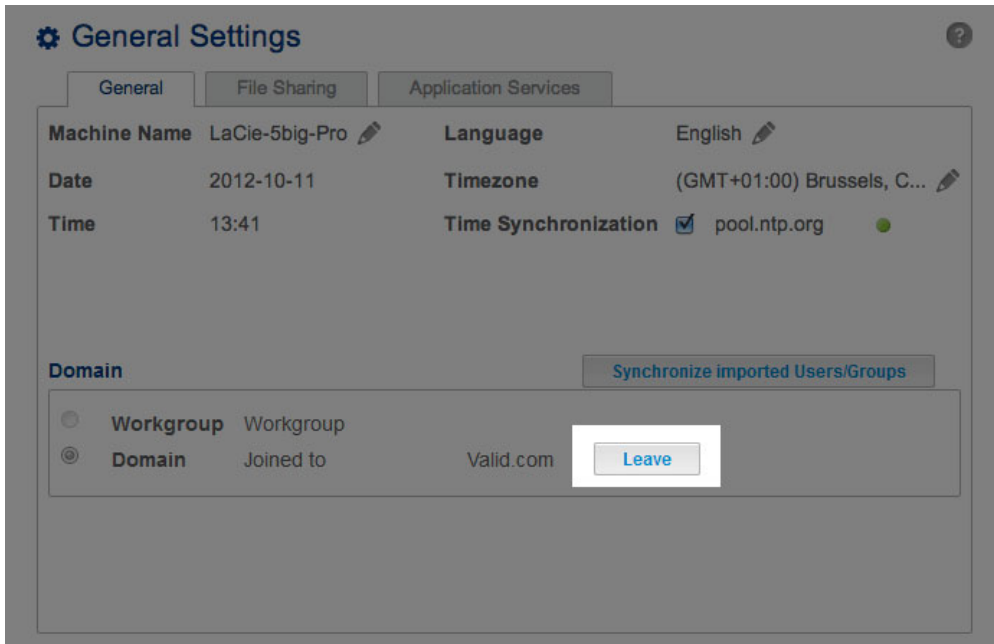

2. Authenticate by inputting the domain administrator's username and password.
3. Users and groups that were imported may still be listed in [Users](#) and [Groups](#). To remove all imported users and groups from the LaCie NAS, choose the button **Remove the imported users/groups** (this button replaces **Synchronize imported users/groups** once you leave a domain).

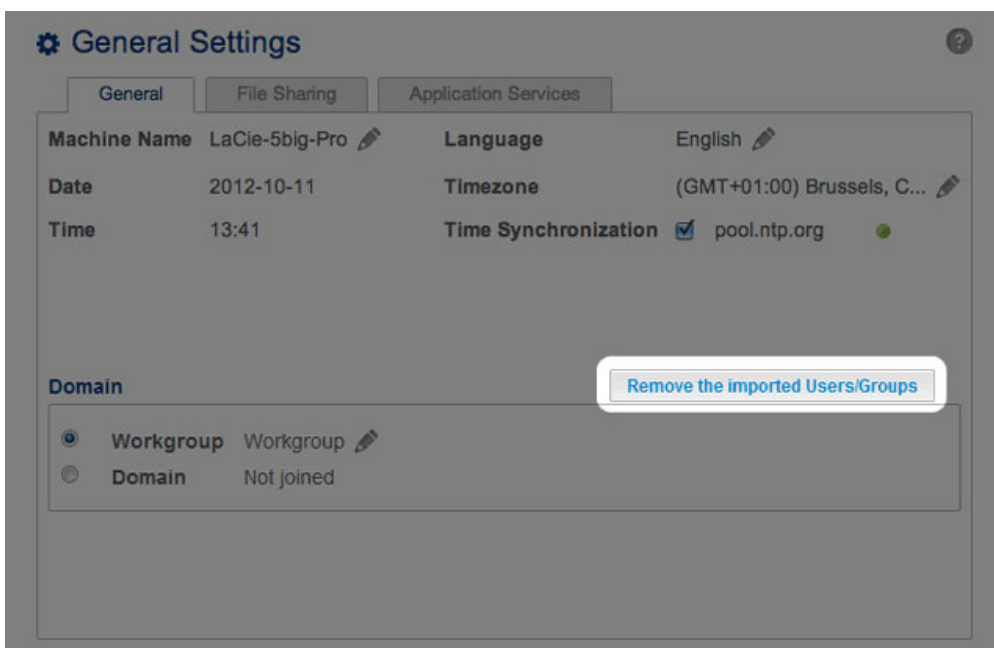

# SERVICES

## File sharing tab

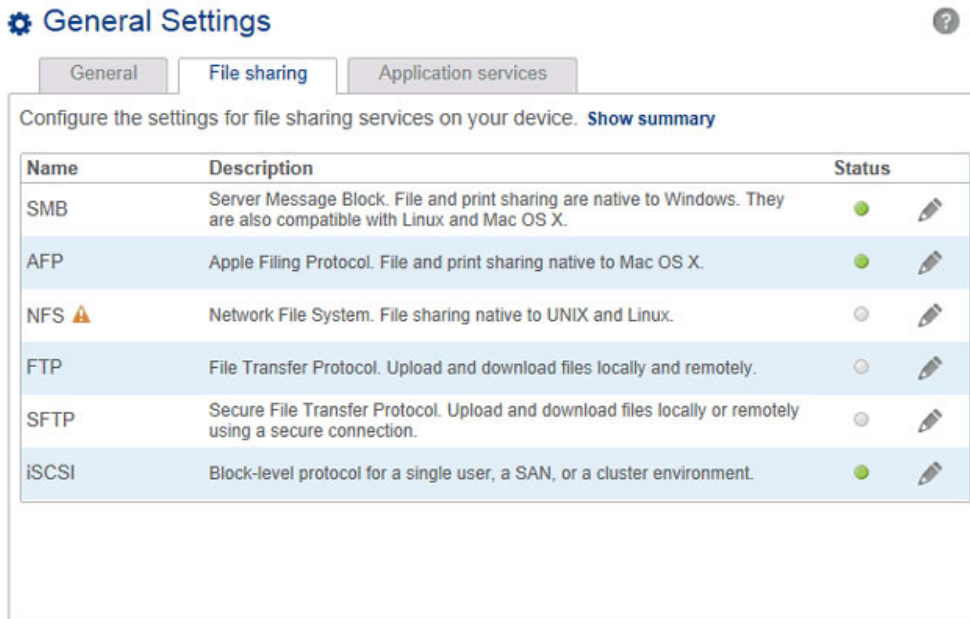

The *File sharing* tab offers a list of file protocols available to the LaCie NAS. Based upon the needs of computers and workstations on the network, the administrator can choose to maintain certain services while leaving others turned off. Examples:

- The administrator may wish to turn AFP (Apple Filing Protocol) off if there are no Macintosh computers on the network.
- The administrator can enable the FTP service in order to provide access to the LaCie NAS via a third-party FTP application. See [Accessing Shares via FTP](#) for details.

## iSCSI: iSNS servers and LAN

The iSCSI service should be used to direct iSCSI target volumes to an iSNS (Internet Storage Name Service) server on the network. Doing so will allow workstations (initiators) to discover the LaCie NAS's iSCSI volume(s) via the iSNS server rather than using a direct connection. Using an iSNS server is ideal when managing multiple iSCSI volumes (targets) and compatible workstations (initiators). To enter the iSNS server IP address:

1. Go to **Dashboard > General Settings > File sharing**.
2. Select the configuration icon for **iSCSI** and then **Advanced parameters**.
3. Choose the checkbox and enter the IP address of the iSNS server.

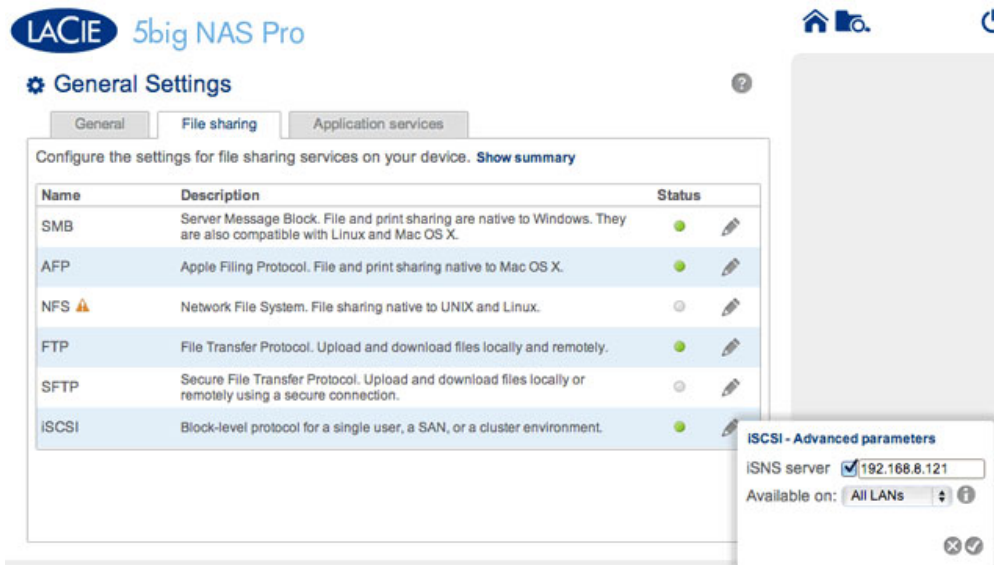

For instructions on creating iSCSI volumes on your LaCie NAS, see [iSCSI Target](#).

You can also limit the iSCSI service to a single LAN:

1. Go to **Dashboard > General Settings > File sharing**.
2. Select the configuration icon for **iSCSI** and then **Advanced parameters**.
3. Select the pull-down menu choose LAN 1 or LAN 2.

**Important info regarding iSCSI volume sharing:** Mounting an iSCSI volume on multiple workstations at the same time will lead to serious file corruption. An exception can be found with SAN cluster environments that include servers and software dedicated to managing iSCSI volume sharing.

## Application services tab

**General Settings** ?

General | File sharing | **Application services**

Configure the settings for application services on your device.

Name	Description	Status
Wuala Hybrid Cloud	Hybrid Cloud storage gives you access to your files anywhere in the world. <a href="#">Learn more.</a>	<span>●</span>
Time Machine	Backup program integrated into Mac OS X only.	<span>●</span>
UPnP/DLNA	Stream multimedia files from your 2big NAS to UPnP and DLNA compatible devices on the network.	<span>●</span>
iTunes™	Stream multimedia files from your 2big NAS to compatible devices on the network using iTunes.	<span>●</span>
Printer server	Share a USB printer on the local network.	<span>●</span>
NetBackup	LaCie NAS and rsync-compatible devices can use your 2big NAS to back up their data.	<span>●</span>
Download machine	Download files (BitTorrent, HTTP, FTP).	<span>●</span>

The *Application services* tab provides a list of services that may be used with the Dashboard or third-party programs.

- Time Machine: See [Backup: LaCie NAS and PC/Mac](#) for details.
- UPnP/DLNA: See [Media \(UPnP/DLNA\) Servers](#) for details.
- iTunes: See [Media \(UPnP/DLNA\) Servers](#) for details.
- NetBackup: See [Remote Backups: Enable NetBackup Server](#) for details. Activating NetBackup server will disable SFTP in the File sharing tab.
- Download machine: See [Download Machine](#) for details.



## Printer server

Your LaCie NAS features a printer server. Follow the directions below to share a printer on the network via the LaCie NAS:

1. Connect your printer to a USB port on your LaCie NAS.
2. In **Dashboard > General Settings > Application services**, check the status of the **Printer server**. A green light indicates that the LaCie NAS has discovered the printer.

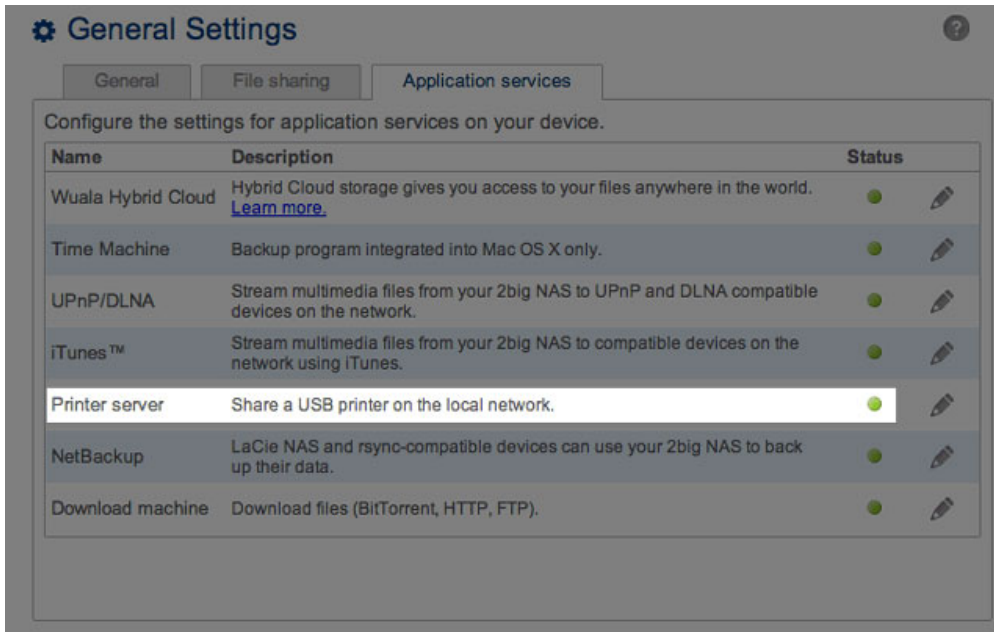

Computer(s) on your network may require specific drivers to use the printer. See the user manual for your printer for details.

**Important info:** For multi-function printers, only the print feature is supported. If your printer has a scan feature, for example, it will not work when connected to the LaCie NAS.

In addition, only PostScript printers are supported. If your printer does not display in the Application services tab, it is likely that the printer does not support PostScript printing. This is frequently the case with multi-function and photo printers. LaCie cannot guarantee that your printer supports the proper protocols to make it a networked printer.

## SERVICE ACTIVATION

There are three levels of service activation: enable/disable, global service activation, and share protocols. The *File Sharing* and *Application Services* tabs allow you to manage the settings for enable/disable and global service activation. The share protocols are managed per share on the [Shares](#) page.

In all cases, enabling/disabling a service will override global service activation and share protocols. If a service is enabled, a green light will be listed in the **Status** column. Not all services are enabled by default.

To **Disable** a service, select the configuration icon for the service.

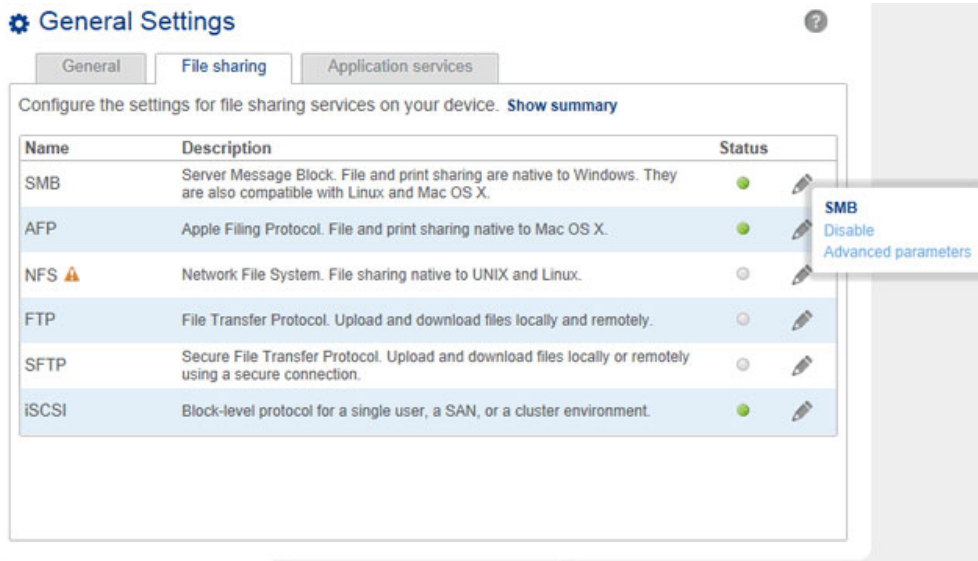

**General Settings** ?

General | **File sharing** | Application services

Configure the settings for file sharing services on your device. [Show summary](#)

Name	Description	Status
SMB	Server Message Block. File and print sharing are native to Windows. They are also compatible with Linux and Mac OS X.	<input checked="" type="checkbox"/>
AFP	Apple Filing Protocol. File and print sharing native to Mac OS X.	<input checked="" type="checkbox"/>
NFS	Network File System. File sharing native to UNIX and Linux.	<input type="checkbox"/>
FTP	File Transfer Protocol. Upload and download files locally and remotely.	<input type="checkbox"/>
SFTP	Secure File Transfer Protocol. Upload and download files locally or remotely using a secure connection.	<input type="checkbox"/>
iSCSI	Block-level protocol for a single user, a SAN, or a cluster environment.	<input checked="" type="checkbox"/>

**SMB**  
Disable  
Advanced parameters

Perform the same action to **Enable** a service.

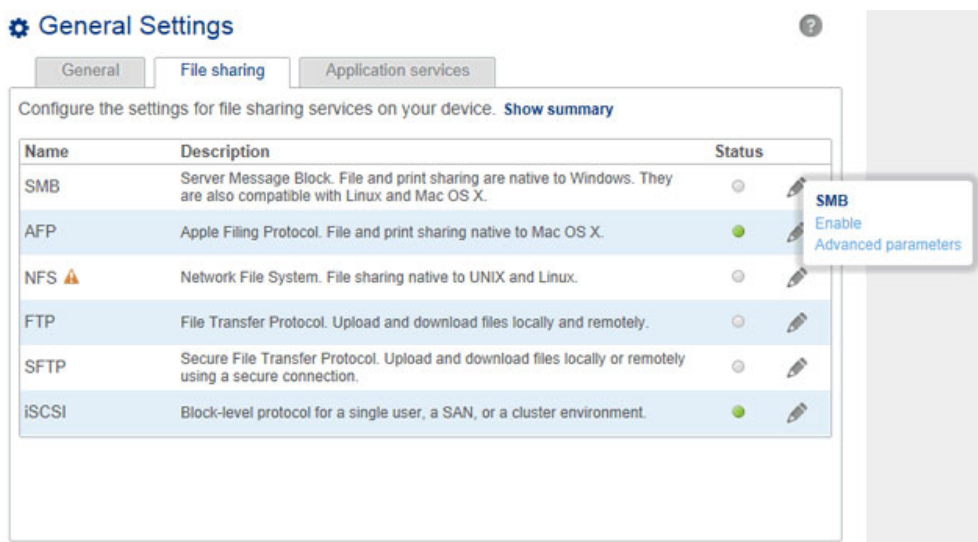

**General Settings** ?

General | **File sharing** | Application services

Configure the settings for file sharing services on your device. [Show summary](#)

Name	Description	Status
SMB	Server Message Block. File and print sharing are native to Windows. They are also compatible with Linux and Mac OS X.	<input type="checkbox"/>
AFP	Apple Filing Protocol. File and print sharing native to Mac OS X.	<input checked="" type="checkbox"/>
NFS	Network File System. File sharing native to UNIX and Linux.	<input type="checkbox"/>
FTP	File Transfer Protocol. Upload and download files locally and remotely.	<input type="checkbox"/>
SFTP	Secure File Transfer Protocol. Upload and download files locally or remotely using a secure connection.	<input type="checkbox"/>
iSCSI	Block-level protocol for a single user, a SAN, or a cluster environment.	<input checked="" type="checkbox"/>

**SMB**  
Enable  
Advanced parameters

To view the **Global service value**, select the configuration icon for **Advanced parameters**. The pulldown menu allows you to deactivate/activate the global service value.

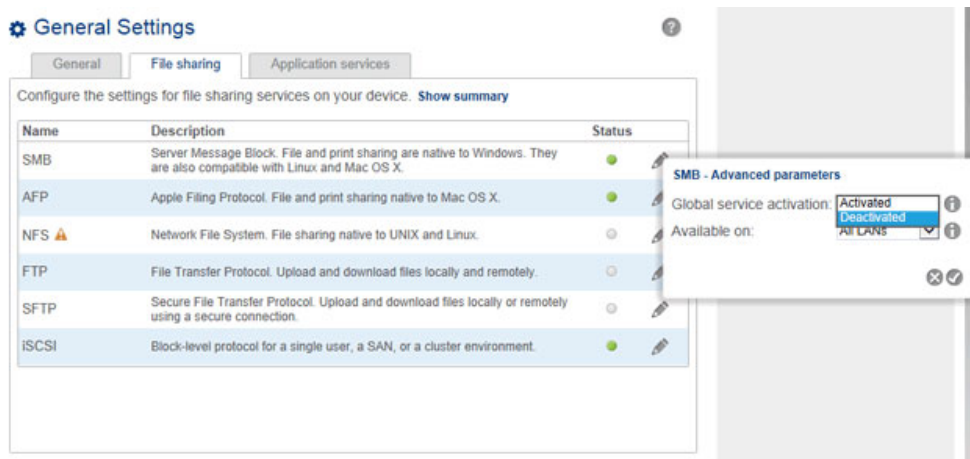
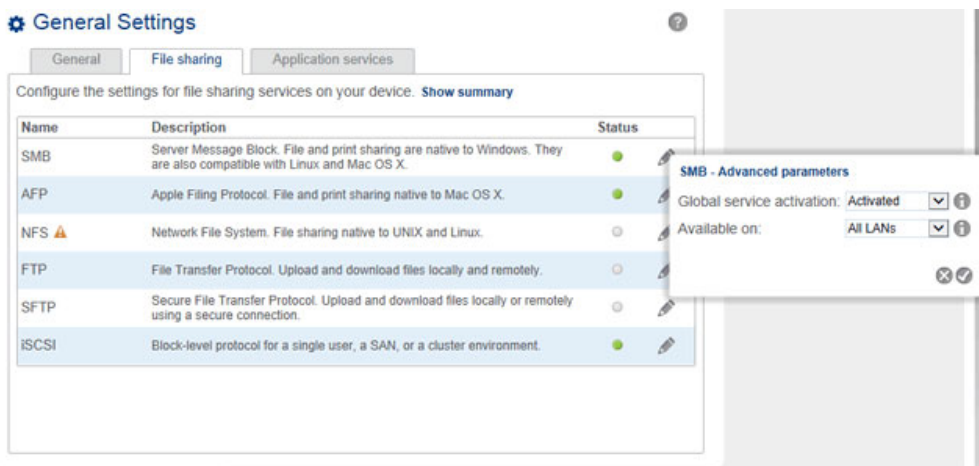

The global service level is, by default, set to **Activated**. This means that the service is ready for use by all shares as long as it is enabled. An administrator can also choose to deactivate a service at the global service activation level while enabling it. Doing so allows the administrator to limit the service to individual shares by adjusting the protocol value in [Shares](#). For example, the administrator may wish to limit the Time Machine service to a single share that is only available to Macintosh computers on the network.

See the table below for examples of service settings:

Enable/Disable	Global Service Value	Share Protocols	Use
Enable	Activated	Set to <i>Global</i> .	The service is ready for use.
Disable	Activated	Set to <i>Global</i> .	The service is not available.
Enable	Deactivated	Set to <i>Activated</i> .	The service is available to the specific share.
Enable	Activated	Set to <i>Deactivated</i> .	The service is not available to the specific share.

See [Shares](#) for instructions on adjusting the settings for share protocols.

## Ethernet ports (LAN) and services (5big NAS Pro only)

The administrator can limit certain services to a LAN port by selecting the configuration icon and then **Advanced parameters**. Use the pulldown menu to select the preferred LAN port for the service.

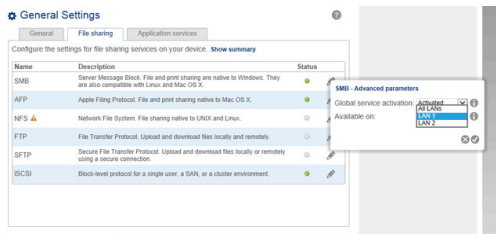

## Services summary

Review the status for all services by choosing **Show summary** in the File sharing or Application services tabs.

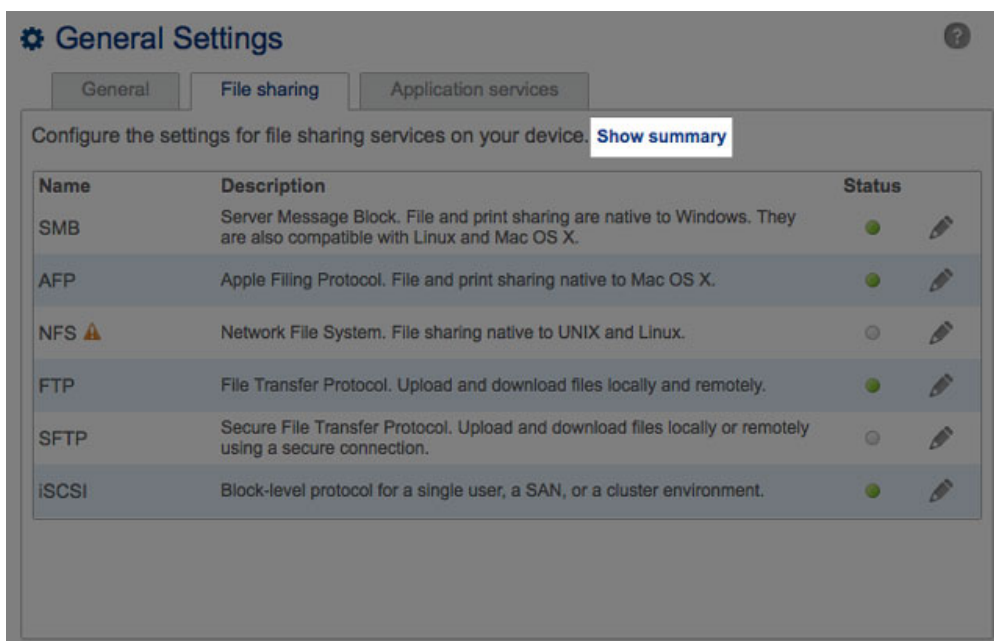

## Service summary



Name	LAN 1	LAN 2
File sharing		
SMB	<input checked="" type="checkbox"/>	<input checked="" type="checkbox"/>
AFP	<input checked="" type="checkbox"/>	<input checked="" type="checkbox"/>
NFS	<input type="checkbox"/>	<input type="checkbox"/>
FTP	<input checked="" type="checkbox"/>	<input checked="" type="checkbox"/>
SFTP	<input type="checkbox"/>	<input type="checkbox"/>
iSCSI	<input checked="" type="checkbox"/>	<input checked="" type="checkbox"/>
Application services		
Wuala Hybrid Cloud	<input checked="" type="checkbox"/>	<input checked="" type="checkbox"/>
Time Machine	<input type="checkbox"/>	<input type="checkbox"/>
UPnP/DLNA	<input type="checkbox"/>	<input type="checkbox"/>
iTunes™	<input type="checkbox"/>	<input type="checkbox"/>
Bonjour	<input checked="" type="checkbox"/>	<input checked="" type="checkbox"/>
Printer server	<input checked="" type="checkbox"/>	<input checked="" type="checkbox"/>
NetBackup	<input checked="" type="checkbox"/>	<input checked="" type="checkbox"/>
Download machine	<input checked="" type="checkbox"/>	<input checked="" type="checkbox"/>

# NETWORK

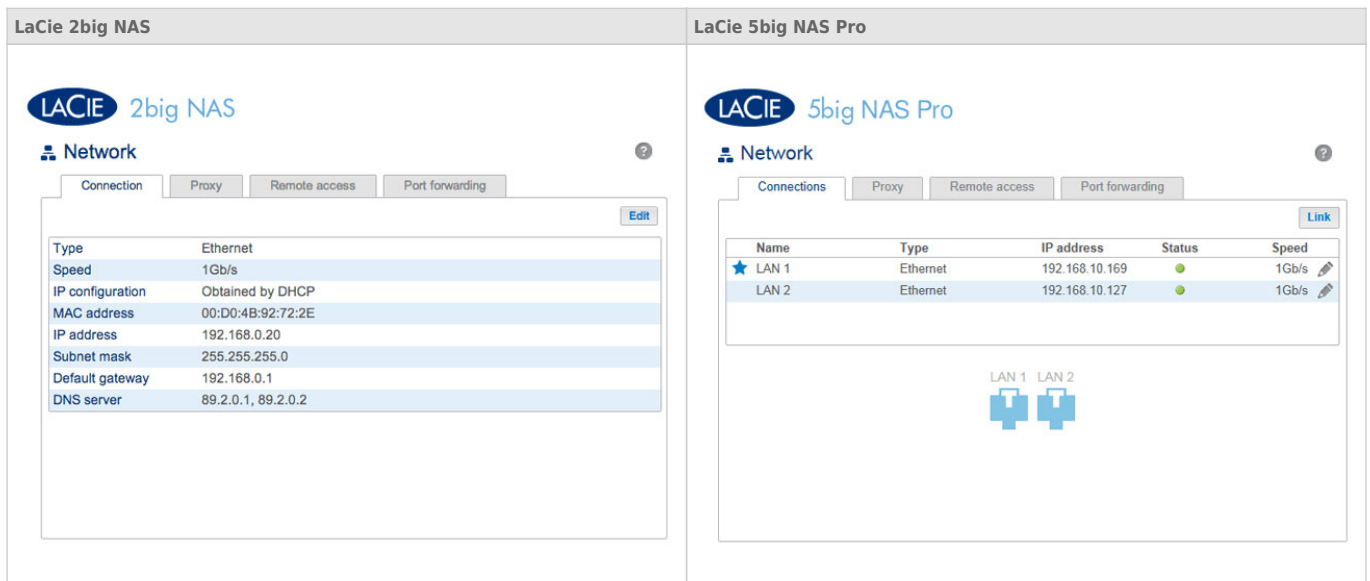

## CONNECTION TAB

If your network is DHCP-enabled, your LaCie NAS will automatically be assigned an IP address and other values. The LaCie 2big NAS has a single LAN port while the LaCie 5big NAS Pro includes two LAN ports (see below). If you wish to review or modify the values of a LAN port:

- LaCie 2big NAS: Choose the **Edit** button.
- LaCie 5big NAS Pro: Select the configuration icon (pencil) then choose **Details** or **Edit**.

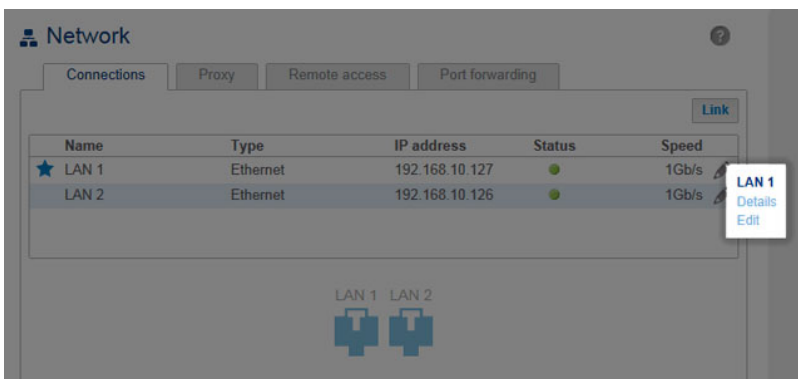

## LAN 1 - Details



Name	LAN 1
Status	Connected
Type	Ethernet
Speed	1Gb/s
IP Configuration	Obtained by DHCP
MAC address	7E:3D:7E:3B:07:D4
IP Address	192.168.10.62
Subnet Mask	255.255.255.0
Default Gateway	192.168.10.2
DNS Server	192.168.10.1

### LAN Details - 5big NAS Pro

Selecting **Edit** allows you to modify certain network parameters. You can manually adjust network values by choosing **Manual configuration** and give the LAN port a unique name (LaCie 5big NAS Pro only). Make certain to check the box next to **Default gateway** to enter or revise a gateway address. For the manual address to take effect, all fields (including Default Gateway and DNS Server) must be completed before selecting **Apply**. The LAN port will revert to automatic if a field is left blank.

## LAN 1 - Edit



### IP Configuration

Automatic network configuration (DHCP)

Manual configuration

IP Address: 192 . 168 . 10 . 135

Subnet Mask: 255 . 255 . 255 . 0

Default Gateway:  192 . 168 . 10 . 254

DNS Server: 192.168.10.10 +  
192.168.10.12 -  
192.168.27.43

Cancel Apply

### LaCie 2big NAS

## LAN 1 - Edit



Name: LAN 1

### IP Configuration

Automatic network configuration (DHCP)

Manual configuration

IP Address: 192 . 168 . 10 . 163

Subnet Mask: 255 . 255 . 255 . 0

Default Gateway:  192 . 168 . 10 . 254

DNS Server: 192.168.10.10 +  
192.168.10.12 -  
192.168.27.43

Cancel Apply

### LaCie 5big NAS Pro

**Important info on network addressing:** Changes to the IP address must be consistent with the values of the router and/or network. You can lose contact with your LaCie NAS by typing addresses that are not available on your network.

**LaCie 2big NAS users:** Skip to [Proxy Tab](#).



## LaCie 5big NAS Pro Ethernet ports

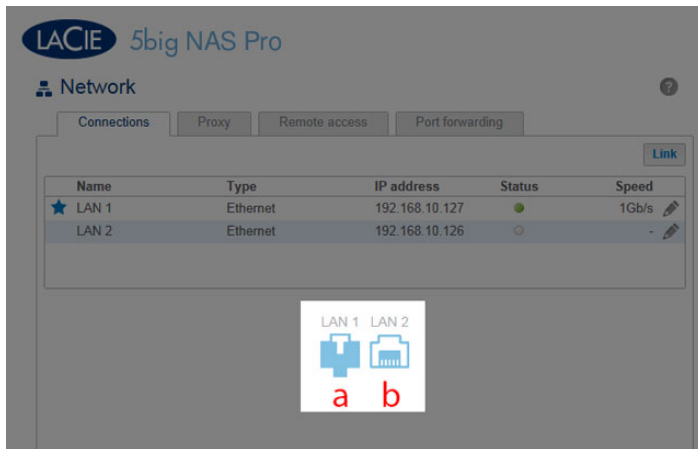

Icons representing the two LAN ports on the *Connections* tab indicate connection to the network:

- Connected: **a**
- Not connected: **b**

## Port aggregation: multiple networks, load balancing, and fault tolerance

The LaCie 5big NAS Pro is equipped with two LAN ports for enhanced network performance. Review the instructions below to learn how to configure the LaCie 5big NAS Pro LAN ports for your network.

Two networks: Bridge the data on your LaCie 5big NAS Pro

The LaCie 5big NAS Pro can be shared by two separate networks.

1. Connect LAN 1 to the first network switch and LAN 2 to the second network switch.
2. Go to **Dashboard > Network** and choose the **Connections** tab.
3. If one or both LANs are not active, select the configuration icon to choose **Enable**.

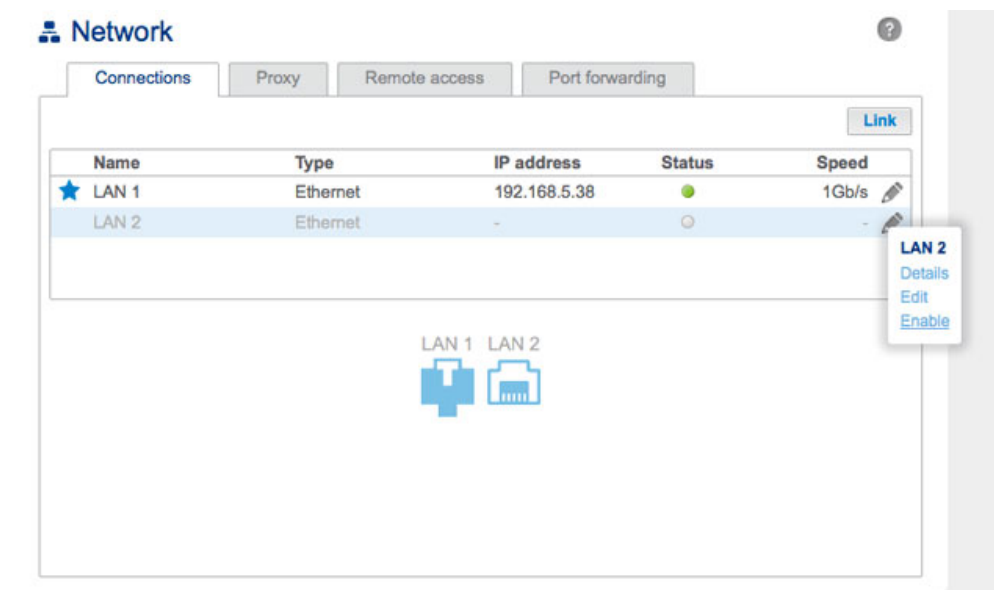

4. Once the LAN is enabled, it can receive a DHCP address from the router. Each LAN should have separate addresses to reflect connection to two separate networks. In the screenshot below, the subnets of the IP addresses (5 for LAN 1 and 1 for LAN 2) demonstrate that each LAN is connected to its own network.

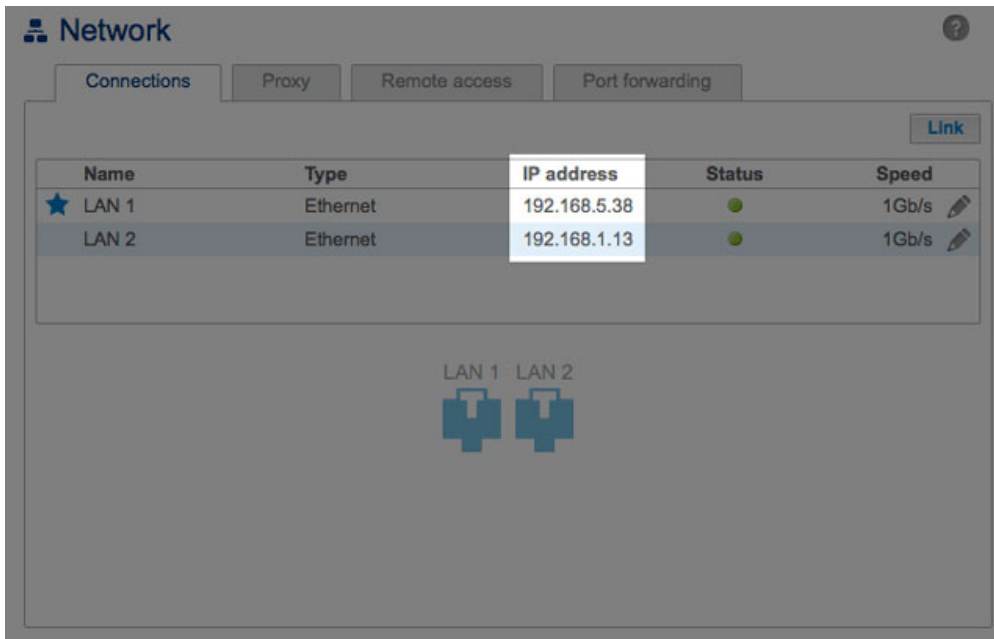

**IP Addressing:** You can manually configure the IP addresses for the LAN connections by selecting their respective configuration icons (pencil) and choosing **Edit**.

Load balancing: enhanced speed

Configure both Ethernet ports to act together for speeds up to 1.5 times faster than a single LAN connection. Additionally, you receive added security should one of the Ethernet cables or ports fail.

Before following the directions below, make certain that your switch or router supports link aggregation:

1. Connect LAN 1 and LAN 2 to the same switch or router.
2. Go to **Dashboard > Network** and choose the **Connections** tab.
3. If one LAN is listed as inactive:
  - Confirm that it is securely connected to the device and to your router.
  - Select its configuration icon (pencil) to choose **Enable**.

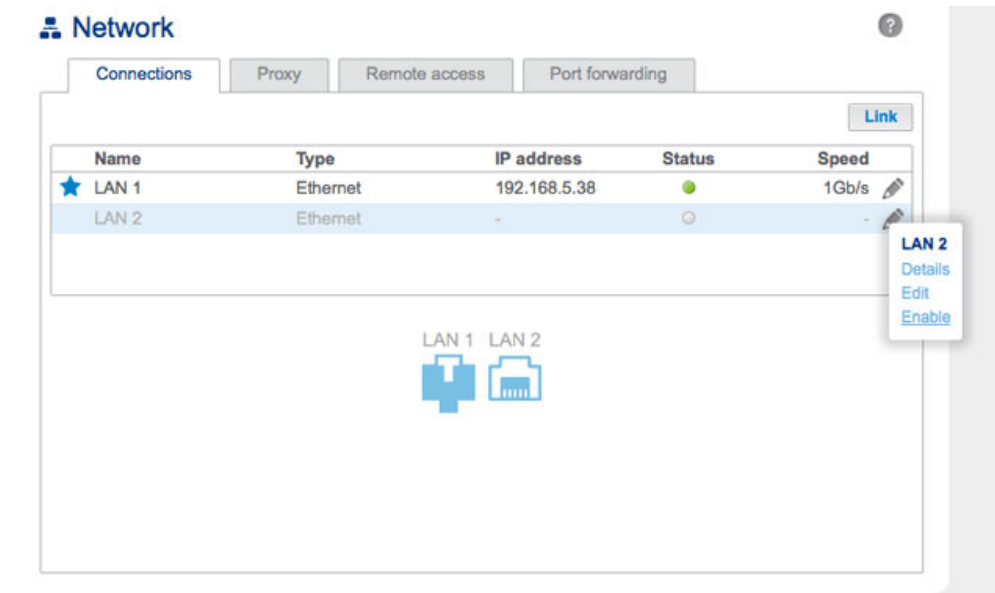

4. With both LANs enabled, choose **Link**.

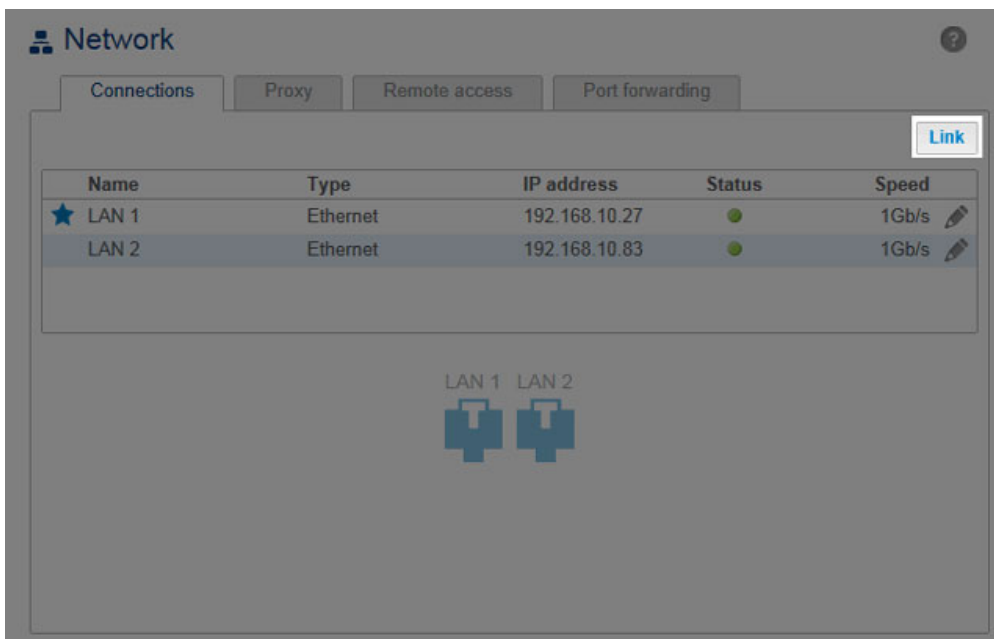

5. Select **Load balancing** then choose **Next**.

## Link aggregation setup



1. Select mode

2. Select interfaces

3. Configure interface

Use Link Aggregation to configure your Ethernet connections for load balancing or fault tolerance.

Select mode:

**Load balancing**

A bond that shares the same speed and duplex settings across the linked connections. Uses the 802.3ad specification.  
Important: LAN cables must be connected to the same switch.

**Fault tolerance**

Active-backup policy: Only one connection in the bond is active. The backup connection becomes active when the active interface fails.

Cancel

Next

6. Check the boxes next to each LAN port then choose **Next**.

## Link aggregation setup



1. Select mode

2. Select interfaces

3. Configure interface

Select the connections to create a link aggregation:

- LAN 1**  
IP address: 192.168.10.27 - Speed: 1Gb/s
- LAN 2**  
IP address: 192.168.10.83 - Speed: 1Gb/s



Cancel

Back

Next

7. You can name the LAN bonding as well as select how the paired Ethernet ports will receive a unified IP address (DHCP or Manual configuration). If you select *Manual configuration*, the IP address must be consistent with the values of your network. Choose **Finish** to complete the bonding.

## Link aggregation setup



1. Select mode

2. Select interfaces

3. Configure interface

Name

IP configuration

Automatic network configuration (DHCP)

Manual

IP address  .  .  .

Subnet mask  .  .  .

Default gateway   .  .  .

DNS server  +  
 -

### *DHCP IP addressing*

## Link aggregation setup



1. Select mode

2. Select interfaces

3. Configure interface

Name

IP configuration

Automatic network configuration (DHCP)

Manual

IP address  .  .  .

Subnet mask  .  .  .

Default gateway   .  .  .

DNS server  +  
 -

### *Manual/Static IP addressing*

8. The two LAN ports are now listed as one.

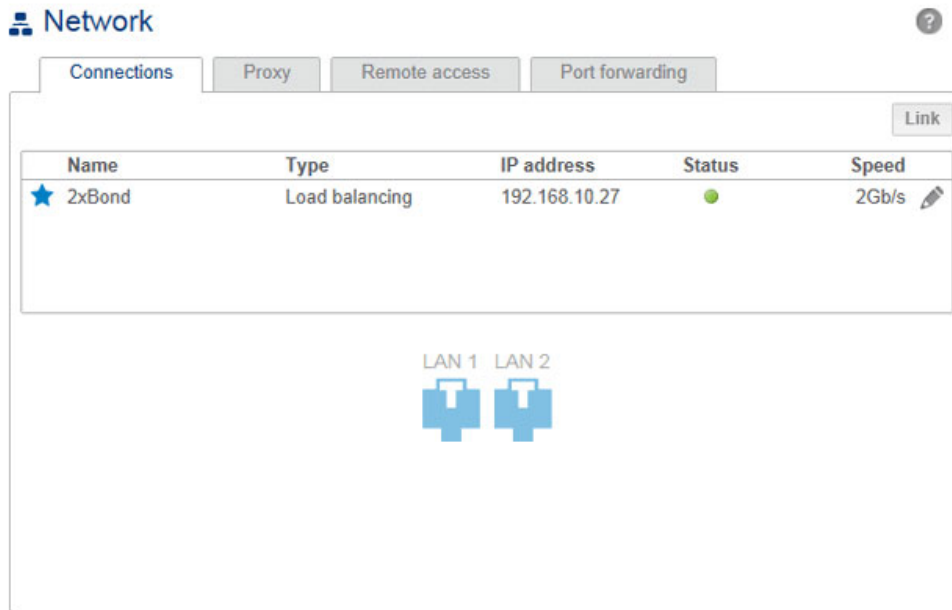

**Break the LAN bond:** If you no longer wish to link the two Ethernet ports, follow the steps below.

1. Choose on the configuration icon (pencil) to select **Remove link**.

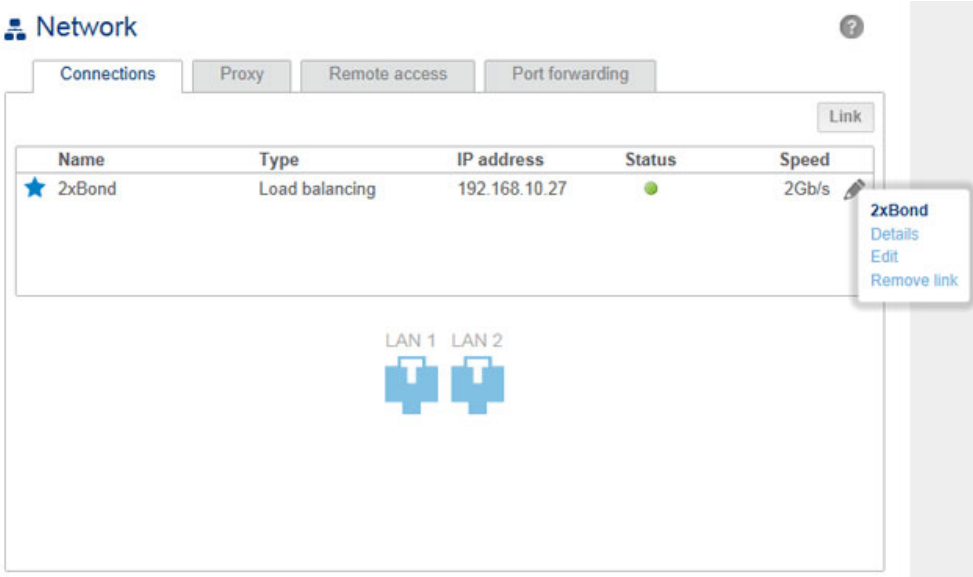

2. Choose **Continue** at the prompt.
3. Removing the link may disable the secondary LAN interface. To reconnect the interface to the network, select the configuration icon for the secondary LAN to choose **Enable**.

Fault tolerance: failover protection

Configure fault tolerance to keep your LaCie 5big NAS Pro connected to the network even if one Ethernet port or cable fails. Before following the directions below, make certain that your network switch or router supports link aggregation.

1. Connect LAN 1 and LAN 2 to the same network switch or router.
2. Go to **Dashboard > Network** and choose the **Connections** tab.
3. If one LAN is not active, select its configuration icon (pencil) to choose **Enable**.

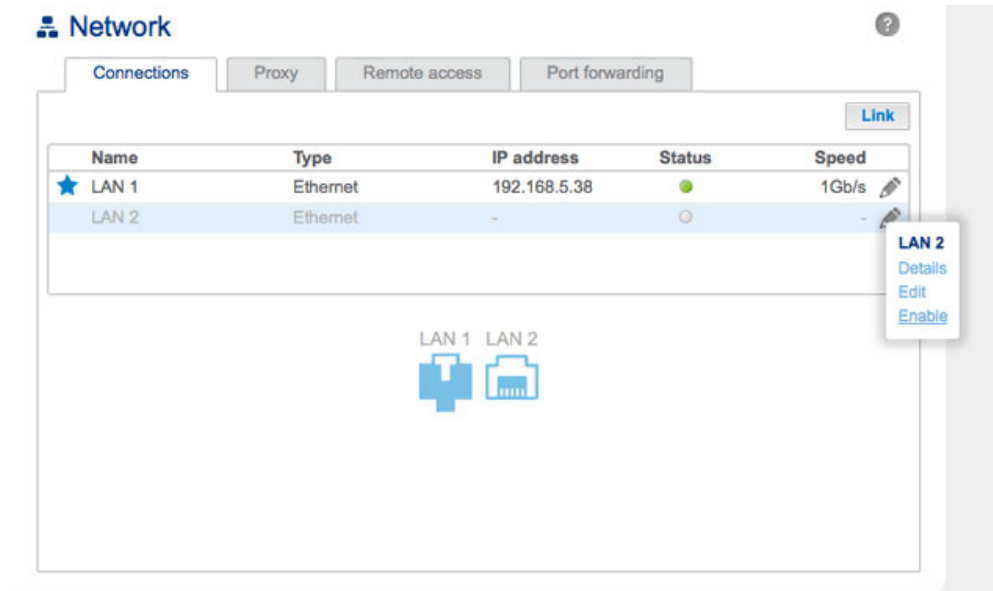

4. With both LANs enabled, choose **Link**.

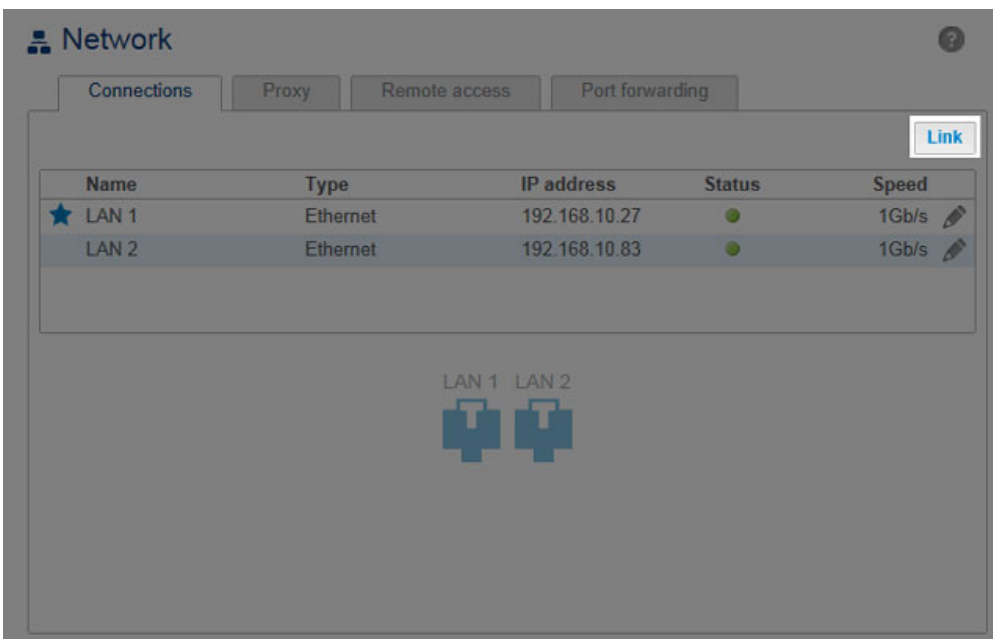

5. Select **Fault tolerance** then choose **Next**.

## Link aggregation setup



1. Select mode

2. Select interfaces

3. Configure interface

Use Link Aggregation to configure your Ethernet connections for load balancing or fault tolerance.

Select mode:

- Load balancing**  
A bond that shares the same speed and duplex settings across the linked connections. Uses the 802.3ad specification.  
Important: LAN cables must be connected to the same switch.
- Fault tolerance**  
Active-backup policy: Only one connection in the bond is active. The backup connection becomes active when the active interface fails.

Cancel

Next

6. Check the boxes next to each LAN port then choose **Next**.

## Link aggregation setup



1. Select mode

2. Select interfaces

3. Configure interface

Select the connections to create a link aggregation:

- LAN 1**  
IP address: 192.168.5.38 - Speed: 1Gb/s
- LAN 2**  
IP address: 192.168.5.39 - Speed: 1Gb/s



Cancel

Back

Next

7. Fault tolerance will switch to the secondary LAN if it cannot detect the primary LAN (see [LAN Priority: Primary LAN Interface](#)). Choose the fault detection for the bond, physical (e.g. a bad Ethernet cable) or logical (e.g. contact with another IP address). For logical fault tolerance, enter the IP address that the LaCie 5big NAS Pro will ping to confirm the stability of the primary LAN and the frequency. The IP address should be for a separate server, a computer on the network, or another device that can manage the task. Choose **Next**.



## Link aggregation setup



1. Select mode

2. Select interfaces

3. Configure interface

Physical detection

Logical detection

Test the IP address  .  .  .

Every (in seconds)

Cancel

Back

Next

8. You can name the fault tolerance configuration as well as select how the Ethernet ports will receive a unified IP address (DHCP or Manual configuration). If you select *Manual configuration*, the IP address must be consistent with the values of your network. Choose **Finish** to complete the bonding.

## Link aggregation setup



1. Select mode

2. Select interfaces

3. Configure interface

Name

IP configuration

Automatic network configuration (DHCP)

Manual

IP address  .  .  .

Subnet mask  .  .  .

Default gateway   .  .  .

DNS server  +  
 -

Cancel

Back

Finish

9. The two LAN ports are now listed as one.

Network

Connections Proxy Remote access Port forwarding

Link

Name	Type	IP address	Status	Speed
★ Bond_Protection	Fault tolerance	192.168.5.38	●	1Gb/s

LAN 1 LAN 2

**Break the Fault Tolerance:** If you no longer wish to keep Fault Tolerance, follow the steps below.

1. Select the configuration icon (pencil) to choose **Remove link**.
2. Choose **Continue** at the prompt.
3. Removing the link may disable the secondary LAN interface. To reconnect the interface to the network, select the configuration icon for the secondary LAN to choose **Enable**.

**Note on failover for bonding versus fault tolerance:** Both bonding and fault tolerance can save you from losing productivity in the event that a single LAN fails (e.g. port, router port, cable, etc.). While the bonded ports can adapt to the loss of one Ethernet signal, it can take a few minutes for the NAS to switch to single LAN mode. Fault tolerance will make the switch instantly, allowing for uninterrupted communication with the NAS.

## LAN priority: primary LAN interface

The primary Ethernet port is marked by a star next to the LAN number. In the example below, LAN 1 is the primary Ethernet port.

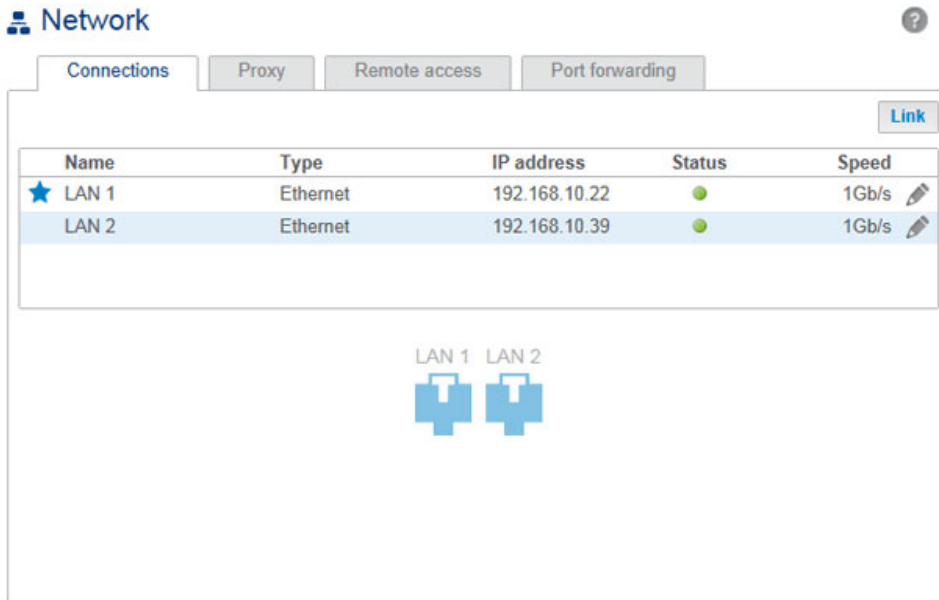

The primary Ethernet port:

- Carries the data when the LaCie 5big NAS Pro is configured in Fault Tolerance
- Acts as the gateway to the internet when the LaCie 5big NAS Pro is connected to two separate networks

**LAN interface and LaCie Network Assistant:** LAN Port 1 must be enabled to use LaCie Network Assistant.

You can change the priority order by reassigning the role of primary port.

1. Select the configuration icon (pencil) for the port you wish to assign as the primary.

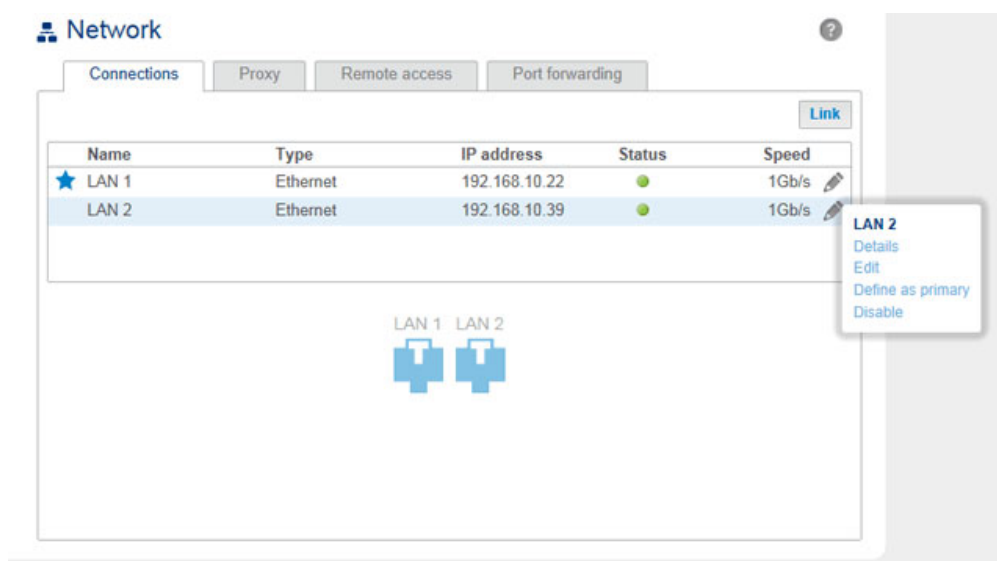



2. Choose **Define as primary**.
3. The star icon will move to the port to reflect the change.

**Network** ?

Connections Proxy Remote access Port forwarding

[Link](#)

Name	Type	IP address	Status	Speed
LAN 1	Ethernet	192.168.10.22	●	1Gb/s 
★ LAN 2	Ethernet	192.168.10.39	●	1Gb/s 

LAN 1 LAN 2



## PROXY TAB

The screenshot shows the 'Network' configuration page with the 'Proxy' tab selected. The page title is 'Network' and it includes a help icon. The main heading is 'Configure how your 5big NAS Pro connects to the Internet \*:'.

Under 'Internet access', there is a green status indicator and a dropdown menu set to 'Proxy server'.

The 'Proxy server' section contains:

- Four input boxes for the IP address, followed by a 'Port' input box containing '3128'.
- An unchecked checkbox for 'Authentication required'.
- A sub-section with 'Name' and 'Password' input fields.
- An 'Apply' button.

A footnote at the bottom states: '\*Internet connectivity is only available on the primary interface (currently: LAN 1)'.

A proxy server may be used to connect compatible network devices to the internet. If necessary, your LaCie NAS can be configured to use a proxy server. First, activate the feature by selecting the **Proxy server** option from the drop-down menu, then fill in the proxy server address, port, and optional authentication information. Choose **Apply** for your changes to take affect.

## REMOTE ACCESS TAB

See [LaCie MyNAS](#).

# PORT FORWARDING TAB

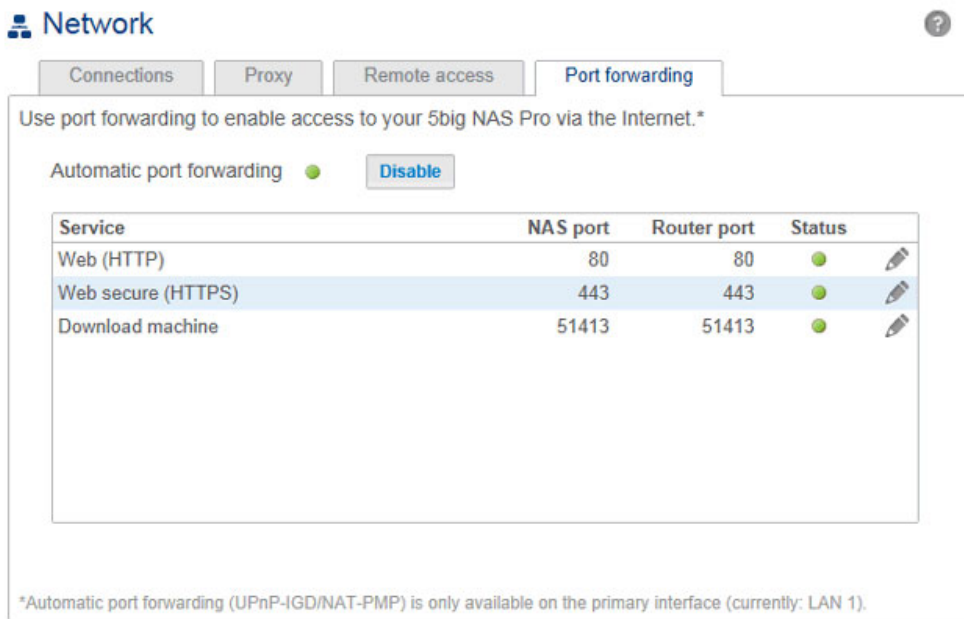

Use this page to manage your LaCie NAS's port forwarding.

To access the internet, file and application services (e.g. HTTP, HTTPS, remote access (see [LaCie MyNAS](#)), download machine, and more) use port numbers on the LaCie NAS and the network router. As seen in the screenshot above, automatic port forwarding is turned on by default and the port numbers are the same for both the *NAS port* and *Router port* columns.

In most instances, automatic port forwarding should help you access services on the NAS. However, enterprise-level network security or port availability on your router can prevent access to ports. Therefore, it may be necessary to change the router port numbers manually for services. Before adjusting numbers in this tab, confirm that the ports you wish to use are available on your router. For example, if you intend to change download machine to router port number 8800, you must make certain that port 8800 is available on your router. Additionally, your router must be compatible with UPnP-IGD/NAT-PMP protocols. See your router's user manual for details.

To change the router port for a service on the NAS, choose its value in the **Router port** column.

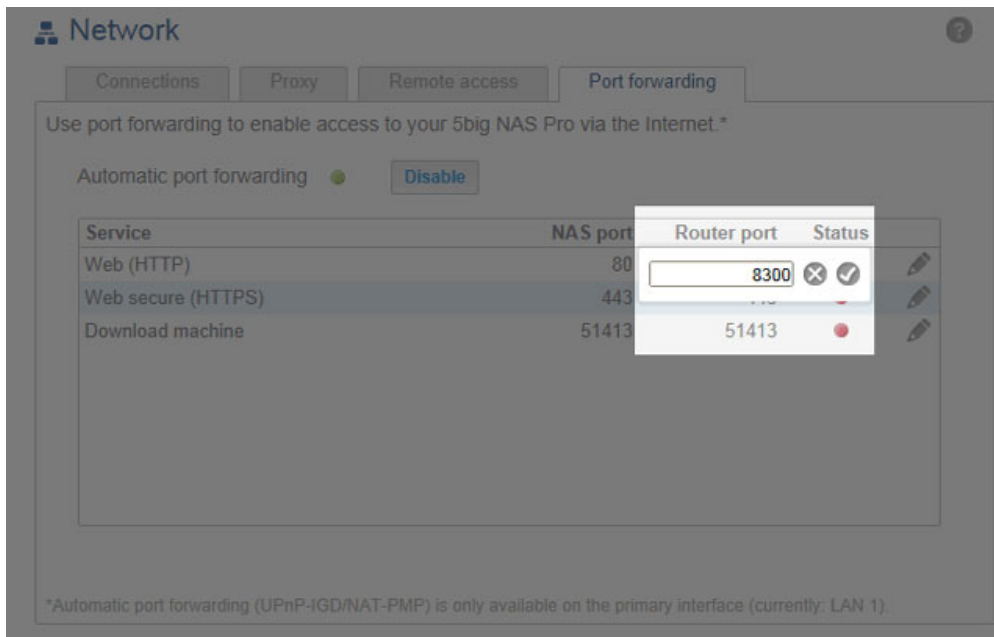

To disable port forwarding for a service, select its configuration icon (pencil) and then choose **Disable**.

**Note on Services in the Port Forwarding tab:** Download machine and other services will appear in this tab once they have been enabled.

# USERS

**Users** Add user ?

Login	Password	Wuala account	Email	Quotas			
Annette	*****		annette@email.com	5	3	○	✎
DJ	*****		dj@email.com	3	2	○	✎
Doug	*****		doug@email.com	3	1	○	✎
Jake	*****	jlashk2	jake@email.com	5	2	○	✎
Jen	*****		jen@email.com	1	0	○	✎
Logan	*****	ljashk2	logan@email.com	2	1	○	✎
Mary	*****		mary@email.com	1	0	○	✎
Mike	*****		mike@email.com	5	1	○	✎
Nancy	*****		nancy@email.com	4	1	○	✎
Paula	*****		paula@email.com	4	2	○	✎
admin	*****	Davidadmin	admin@email.com	6	1	○	✎

This page allows you to manage user accounts.

## ADD A USER

Choose the **Add user** button and fill out the required fields. Your LaCie NAS can have up to 2048 users.

**New user** ×

Login

Password

Confirm password

Email 

Administrator account

Cancel Add user

**Important info:**

The password is case-sensitive.  
In text fields, you may enter from 4 to 20 characters using letters, numbers, symbols, hyphen, and underscores. Do not begin or end with a hyphen or underscore.



## DELETE A USER

Removing a user will delete all the user's settings but not his data.

To delete a user, choose the configuration icon (pencil) at the far-right of the user's row, then choose **Remove**. Confirm in the dialogue window.

## USERS TABLE

User data is organized in a table.

- The icons in the far left of the table indicate a user's rights:
  - Crown: Administrative privileges.
  - Blue user: Standard user privileges.
  - Grey user: Standard user privileges and the user was imported from an active directory.
- Choose the text in the **Login** column to change the user name.
- Choose the text in the **Password** column to change the user's password.
- Choose the text in the **Email** column to change the user's email address.
- The number in the **Shares** (icon) column indicates how many shares the user can access. Choose the number to view the assigned share(s).
- The number in the **Groups** (icon) column shows to how many groups the member belongs. Choose the number to view the group(s).
- Choose on the the configuration icon (pencil) to remove a user or adjust his access rights.

## User rights

A user can access NAS shares that have been assigned to him by the administrator (see [Shares](#)). When accessing the shares, the user will be prompted for the password created by the administrator on the Users page (see [Shares: Access and Transfer Files](#)). In addition, a user can log on to the NAS OS Dashboard using his login and password, which is very helpful with LaCie MyNAS remote access. However, Dashboard rights for a user are limited to:

- The File Browser to upload and download files via the internet (see [File Browser](#))
- Changing his password and preferred language

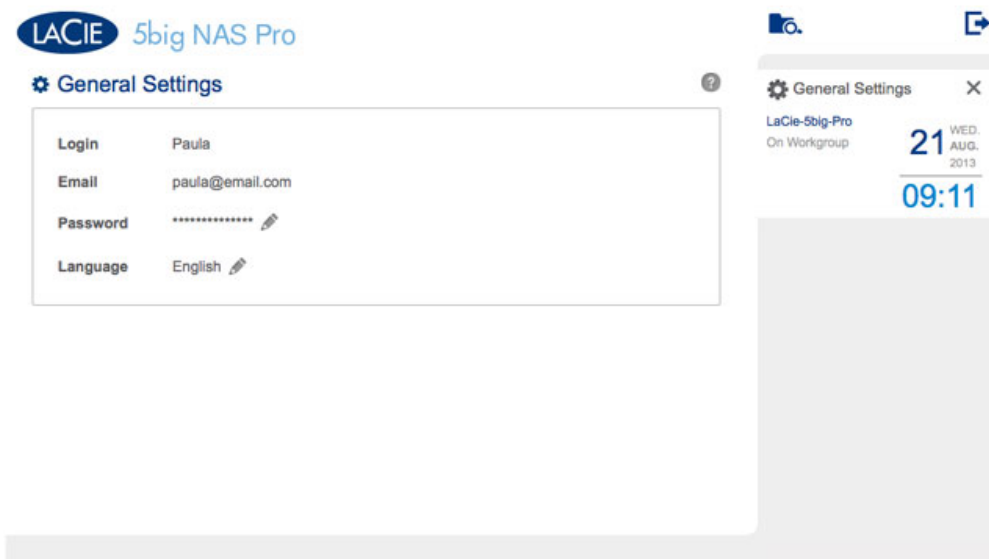

An administrator has access to all Dashboard features, including the ability to revise a password that has been changed by a user.

An administrator can upgrade a user to an administrator. Select the configuration icon (pencil) for the user and choose **Set Administrator**. To revert an administrator to a user, perform the same action and select **Set local user**.

## Importing users from Active Directory

1. If you have successfully connected to an active directory domain (see [General Settings](#)), you will see a button on the **Dashboard > Users** page labelled **Import from domain**. Choose the button.

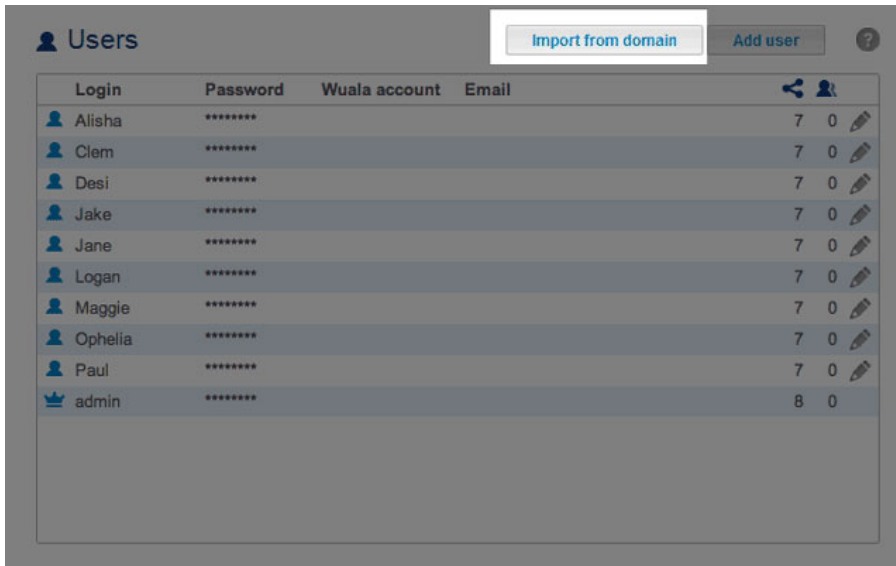

2. At the prompt, type a few characters in the text field to find the user(s) you wish to import.

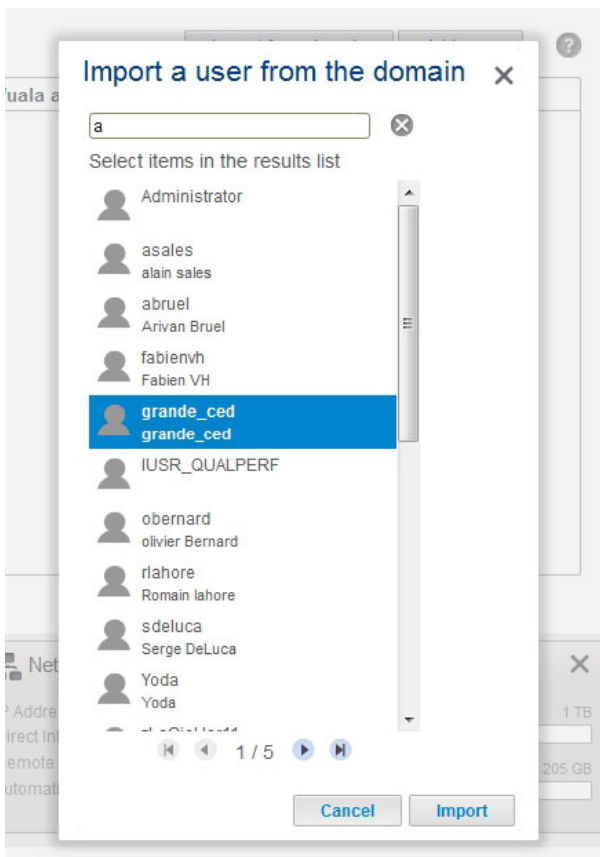

3. Hold down the Ctrl key (Windows users) or Command key (Mac users) to select multiple users.













## Managing users imported from an Active Directory

Users imported from an active directory are managed by the administrator of the original domain. For example, passwords, email accounts, and groups are all determined within the original domain. However, the administrator of the LaCie NAS can remove an imported user from the device by selecting the configuration icon (pencil) at the far-right of the user's row and choosing **Remove**.

Users and groups imported from an active directory may have their rights adjusted by the administrator of the original domain. See [Synchronize Users/Groups](#) for instructions on synchronizing changes from an active directory.

# GROUPS

 **Groups** [Add group](#) 

Group name	Description			Domain	
Accounts	Finance	1	2	<input type="radio"/>	
Design	Creative Group	1	3	<input type="radio"/>	
Documentation	Instructions	3	2	<input type="radio"/>	
Sales-Americas		2	2	<input type="radio"/>	
Sales-Europe		2	2	<input type="radio"/>	
Software	User Interface	2	3	<input type="radio"/>	

Assigning users to groups gives you powerful tools to manage large numbers of users and their privileges. Administrators can set access rights to entire groups rather than individually.

**Important info:** In text fields, you may enter 1 to 20 characters using letters, numbers, hyphen, and underscore. No other symbols, special characters, punctuation, or spaces may be used. Do not begin or end with a hyphen or underscore.

## NEW GROUP

Choose **Add group** and fill out the required fields. Your LaCie NAS can have up to 256 groups.

**New group** ×

Group name

Description

## DELETE A GROUP

To delete a group, choose the configuration icon (pencil), then select **Delete**. Confirm in the dialogue window. Deleting a group will not affect the data created by users in the group.

## EXISTING GROUP

Group data is organized in a table.

- Choose the text in the **Group name** column to change the group name.
- Choose the empty space or text in the **Description** column to add or revise details for the group (optional).
- The number in the **Shares** column (connected dots icon) shows how many shares the group has access to. Choose the number to view the share(s).
- The number in the **Users** column (user icon) shows how many users belong to the group. Choose the number to view the user(s).
- A green light in the **Domain** column indicates that the group has been imported from a domain.
- Select the configuration icon (pencil) and choose:
  - **Users** to modify group members. In the resulting window, highlight a user, then choose the arrows to join/disjoin a user from the group.

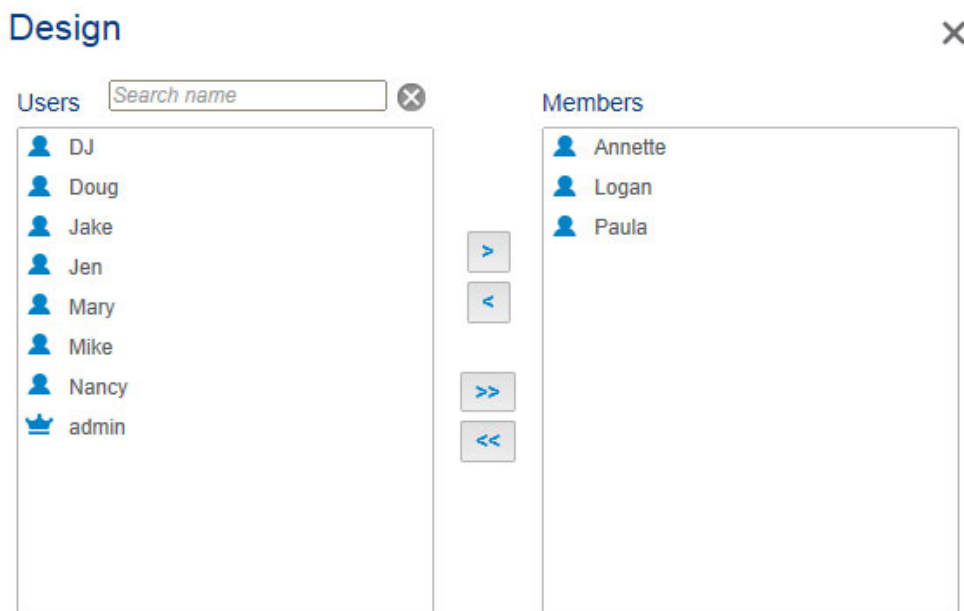

- **Delete** to remove the group.



## IMPORTING GROUPS FROM ACTIVE DIRECTORY

1. If you have successfully connected to an active directory domain (see [General Settings](#)), you will see a button labelled **Import from domain**. Choose the button.

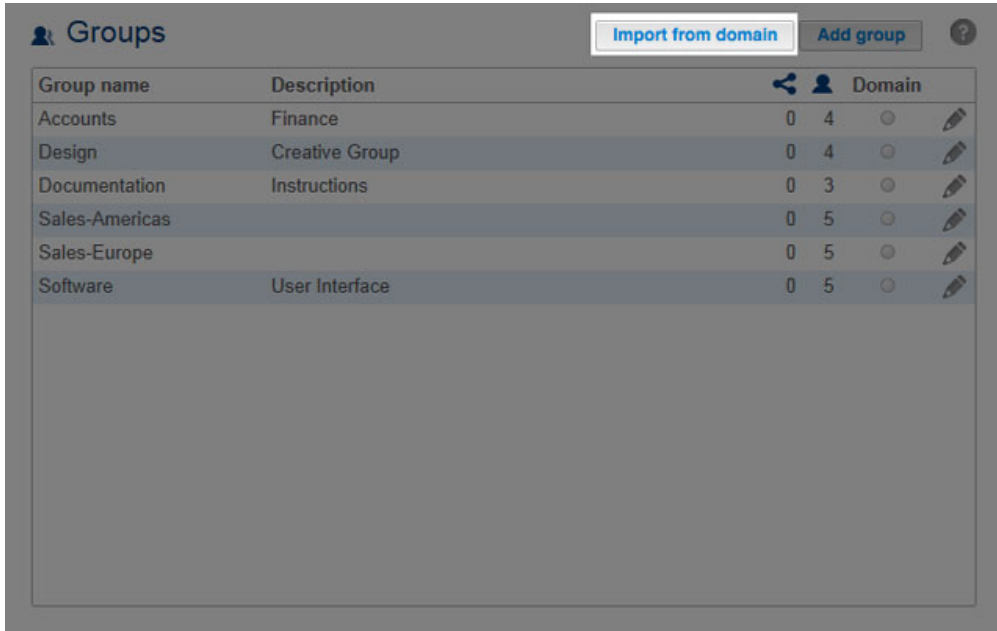

2. A prompt allows you to search for groups on the domain. Begin by entering a the first letter of the group.

## Import the group from the domain ✕

A ✕

Select items in the results list

- Account Operators
- Administrators
- Allowed RODC Password Replication Group
- Backup Operators
- Certificate Service DCOM Access
- Cryptographic Operators
- Denied RODC Password Replication Group
- DnsAdmins
- DnsUpdateProxy
- Domain Admins
- Domain Computers
- Domain Controllers
- Domain Guests
- Domain Users

1 / 5

Cancel Import

3. To select multiple groups, hold down the Command key (Mac users) or Control key (Windows users).
4. Choose the **Import** button.
5. The imported groups will appear in the table with a green circle in the **Domain** column.

### Groups

Import from domain Add group ?

Group name	Description			Domain	
Accounts	Finance	0	4	<input type="radio"/>	
Design	Creative Group	0	4	<input type="radio"/>	
Documentation	Instructions	0	3	<input type="radio"/>	
Sales-Americas		0	5	<input type="radio"/>	
Sales-Europe		0	5	<input type="radio"/>	
Software	User Interface	0	5	<input type="radio"/>	
Account Operators	Members can administer domain user and group accounts	0		<input checked="" type="radio"/>	
Administrators	Administrators have complete and unrestricted access to th	0		<input checked="" type="radio"/>	
Backup Operators	Backup Operators can override security restrictions for the	0		<input checked="" type="radio"/>	
Cryptographic Operators	Members are authorized to perform cryptographic operator	0		<input checked="" type="radio"/>	

## MANAGING GROUPS IMPORTED FROM AN ACTIVE DIRECTORY

Groups imported from an active directory are managed by the administrator of the original domain. However, the administrator of the LaCie NAS can delete an imported group from the device by selecting the configuration icon (pencil) and **Delete**.

Users and groups imported from an active directory may have their rights adjusted by the administrator of the original domain. See [Synchronize Users/Groups](#) for instructions on synchronizing changes from an active directory.

# SHARES

Shares Add share ?

Name	Description	Volume			Protocols	
Corporate-Calendar		RAID 0	0	0		
Creative	Design and packaging	SimplyRAID	0	0		
Customer-Queries		RAID 0	0	0		
Mac-TM	Time Machine backups	SimplyRAID	0	0		
Marketing		SimplyRAID	0	0		
Project-Planning		RAID 0	0	0		
Public		SimplyRAID	Public	Public		
admin		SimplyRAID	0	1		

Your LaCie NAS's storage is divided into shares, also known as network folders. This page allows you to create new shares, assign access rights to users and groups, and to adjust share protocols. By default, your LaCie NAS has two shares, *admin* and *Public*. You can begin working with these shares immediately or create new shares.

**Note on the admin share name:** The name of the share *admin* will update automatically if the administrator changes the login name from the default **admin** (see [Connect to the Network](#)).

**Important info:** In text fields, you can enter 1 to 20 characters using letters, numbers, hyphen, and underscore. No other symbols, special characters, punctuation, or spaces may be used. Do not begin or end with a hyphen or underscore.

# PUBLIC AND PRIVATE SHARES

The following table shows the differences between public and private shares:

Name	Accessibility	Login	Availability
Private	Accessible only to assigned users	Password-protected (user password)	Computers on the network and remote access (must be enabled)
Public	Public, accessible to any user on the network	None	Computers on the network and remote access (must be enabled)

## NEW SHARE

Choose **Add share** and fill out the required fields. If you have more than one volume, a pulldown menu allows you to select the volume for the share. Your LaCie NAS can have up to 256 shares.

**New share** ✕

Name

Description

Public

### Single volume

**New share** ✕

Name

Description

Public

Location

### Multiple volumes

## EXISTING SHARES

Shares are organized in a table.

- Click on the text in the **Name** column to change the share name.
- Click on the empty space or text in the **Description** column to add or revise details for the share (optional).
- The number in the **Groups** column (two silhouettes) shows how many groups have access to the share. Click on the number to view and edit the group. *Public* indicates that the share is available to everyone on the network.
- The number in the **Users** column (one silhouette) shows how many users have access to the share. Click on the number to view and edit the user. *Public* indicates that the share is available to everyone on the network.
- Click on the blue circle in the **Protocols** column to open the **Access protocols** dialogue window. See [Share Protocols](#).
- Click on the configuration icon (pencil) for the share's settings menu. Most of the options in this menu are explained above, except for the ability to make the share public/private or to delete the share.

## SHARE PROTOCOLS: SPECIFIC VALUES FOR SERVICES

For a full description of services, please see [Service Priority](#).

The blue circle in the *Status* column indicates that a service follows the global service value. The circle will become white if the service for the share does not adhere to the global service value. A red circle means that the service has not been turned on in [General Settings](#).

### Access protocols for Public ✕

Service	Status	Activated	Deactivated	Global <span style="font-size: 0.8em;">i</span>
SMB	<input type="radio"/>	<input type="radio"/>	<input checked="" type="radio"/>	<input type="radio"/>
AFP	<input checked="" type="radio"/>	<input type="radio"/>	<input type="radio"/>	<input checked="" type="radio"/>
NFS <span style="color: orange;">⚠</span>	<input checked="" type="radio"/>	<input type="radio"/>	<input type="radio"/>	<input checked="" type="radio"/>
FTP	<input checked="" type="radio"/>	<input type="radio"/>	<input type="radio"/>	<input checked="" type="radio"/>
SFTP	<input checked="" type="radio"/>	<input type="radio"/>	<input type="radio"/>	<input checked="" type="radio"/>
Time Machine	<input checked="" type="radio"/>	<input type="radio"/>	<input type="radio"/>	<input checked="" type="radio"/>
UPnP/DLNA	<input checked="" type="radio"/>	<input type="radio"/>	<input type="radio"/>	<input checked="" type="radio"/>
iTunes™	<input checked="" type="radio"/>	<input type="radio"/>	<input type="radio"/>	<input checked="" type="radio"/>

- The service is available for this share.
- The service is not available for this share.
- The service is off. You can turn services on in [General settings](#).

Cancel
Apply

An administrator will change the share protocol when the:

- Global service value is deactivated.
- Enable/Disable is set to **Enable**.

Both settings are available in [General Settings](#). To change a protocol for a specific share:

1. From **Dashboard > Shares**, locate the share you want to change and then select one of the following:
  - Click on the circle (blue/yellow)
  - Select the configuration icon (pencil) to choose **Access protocols**.
2. Select the radio button in the **Activated** or **Deactivated** columns to turn the service on or off for the share.

# MANAGE SHARE ACCESS

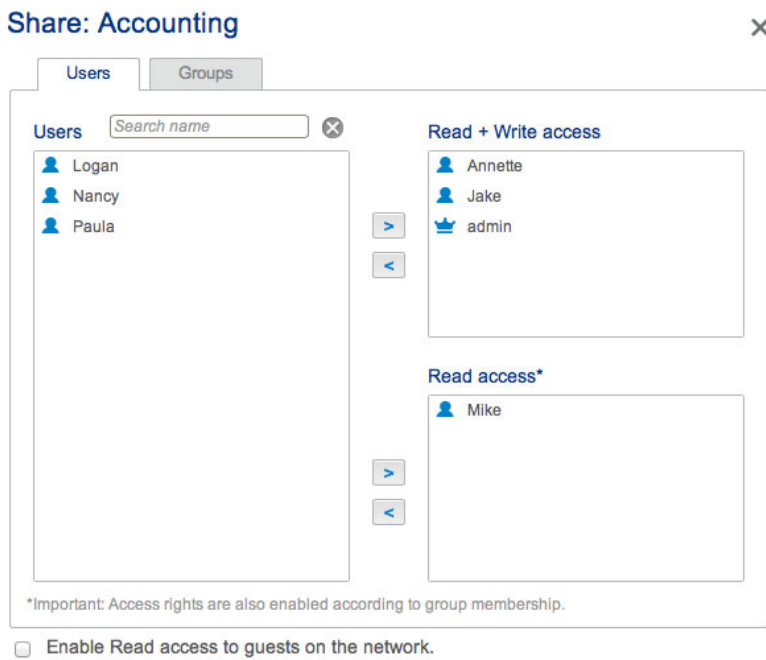

1. Choose the configuration icon (pencil) in the right-hand column and select either the **Users** or **Groups** tab. You can also click on the numbers in the Users or Groups columns associated with the share.
2. In the left-hand column of the resulting window, the users or groups without access to the share are listed. Select the user or group to be granted access, then choose the add arrow (pointing right) either to the **Read + Write access** cell or to the **Read access** cell.

To withdraw access, select a user or group in the **Read + Write access** or **Read access** cell and choose the remove arrow (pointing left).

Check the box next to **Enable Read access to guests on the network** to give read-only access to anyone on the network, including non-users.



## DELETE A SHARE

**Deleting a share and data:** Note that deleting a share also deletes all files on the share and will cause any associated backup jobs to fail.

1. Select the configuration icon (pencil) to choose **Delete**.
2. Confirm in the dialogue window.

# HARDWARE MONITORING

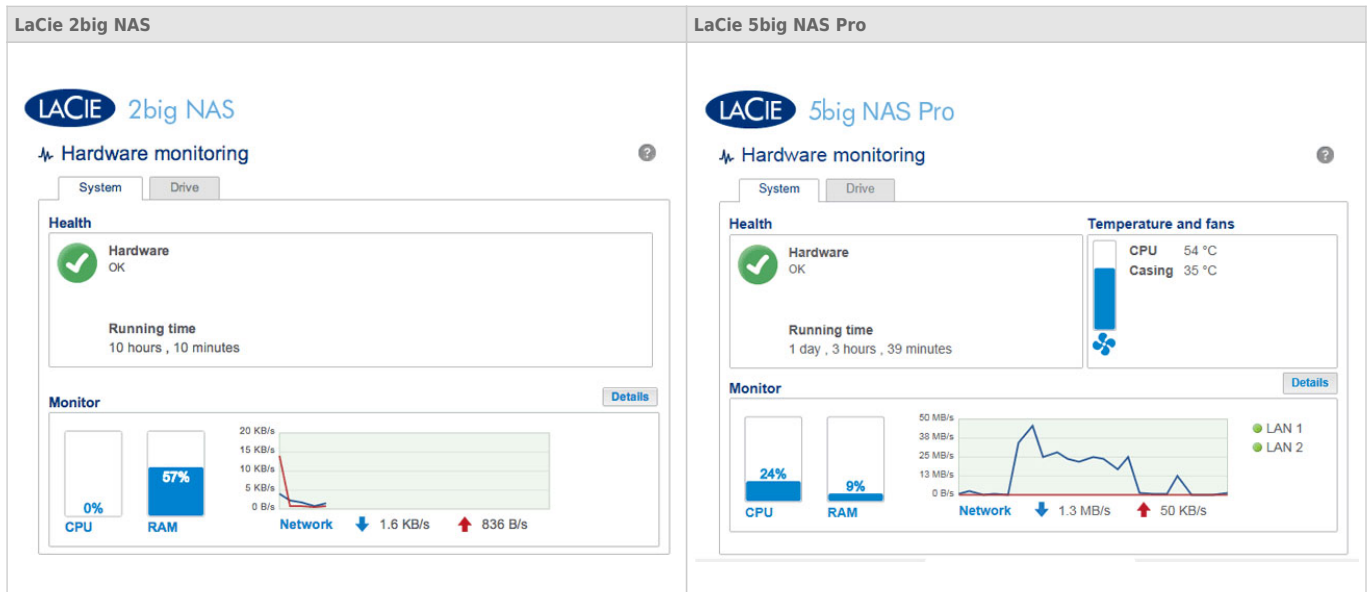

Hardware monitoring provides a summary of the LaCie NAS's hardware and the health of its components.

# SYSTEM TAB

2big NAS

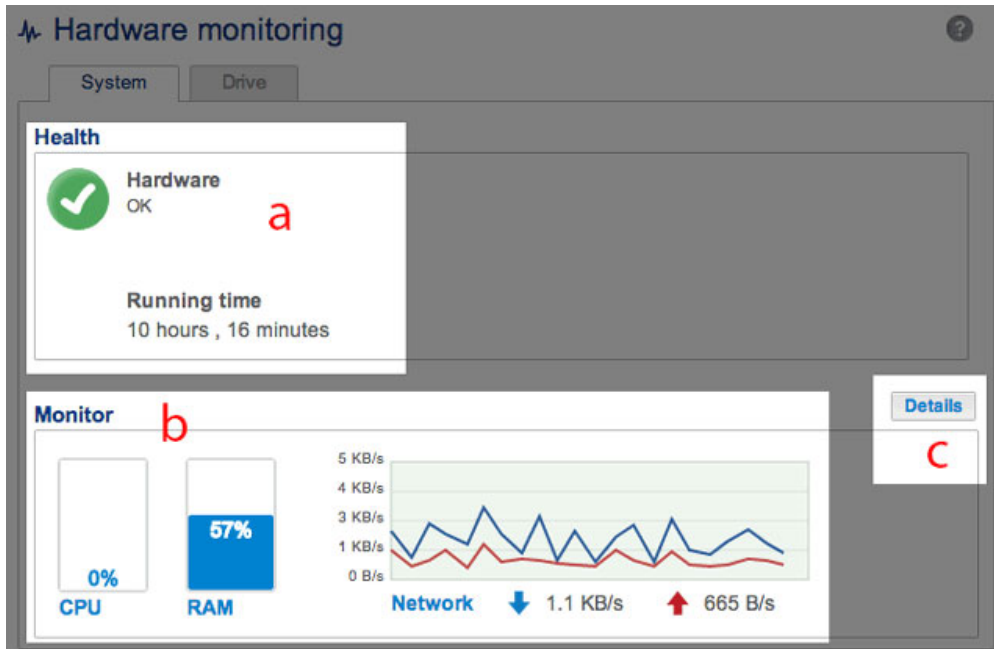

- a: A white check mark within a green circle indicates that your hardware is operational and there are no problems.  
A red circle with a white “X” alerts you to potential problems with the hardware. The red circle is accompanied by an error message, such as the device has reached a critical temperature (see note below).  
The running time indicates consecutive hours and minutes of operation. The clock will restart each time the device is powered on, restarted, or wakes up from deep sleep mode.
- b: Review the performance meters for the CPU, RAM, and Network.
- c: Choose **Details** to view expanded graphs of the CPU, RAM, and Network meters.

## Monitor details

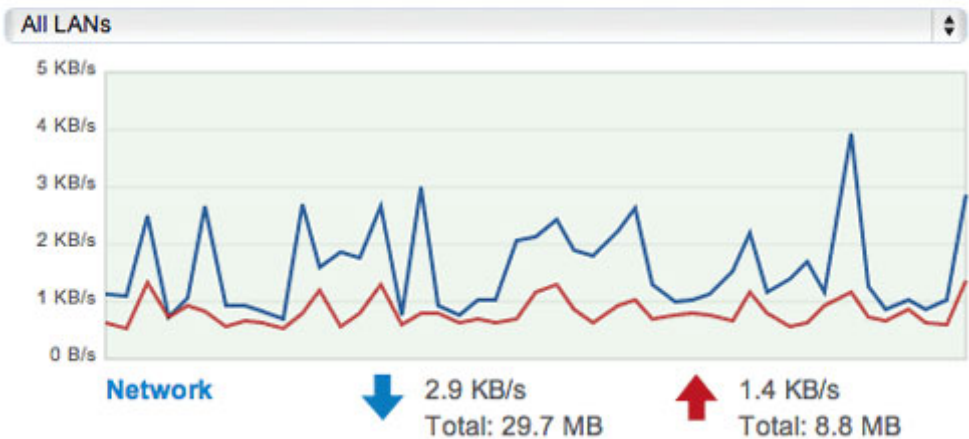
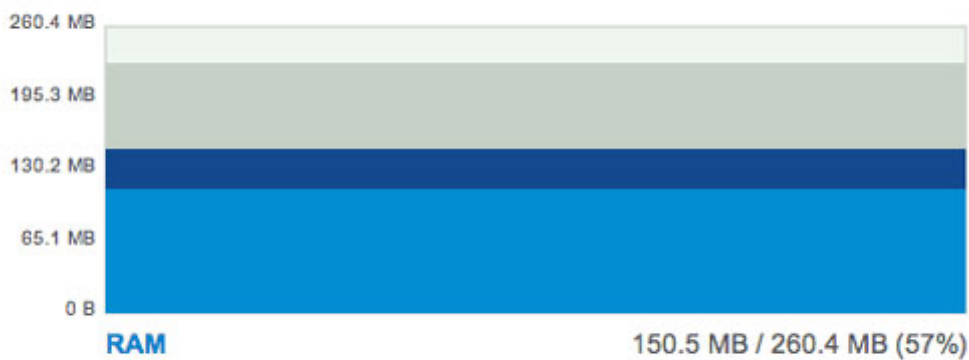
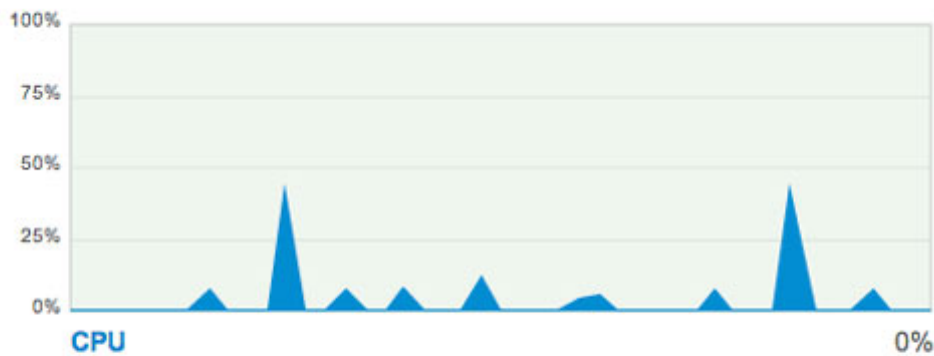

### Temperature and fans:

- Temperature error: Check the placement of your LaCie NAS to make certain that it is not receiving an abnormal amount of heat from external sources (e.g. sun from a window, heating duct, exhaust from other electronics, etc.).  
If the problem persists, see [Getting Help](#) for links to contact customer support.
- Drive error: Select the **Drive** tab to review the status for the LaCie NAS disks. See [Drive tab](#) for instructions on running tests on the disks.

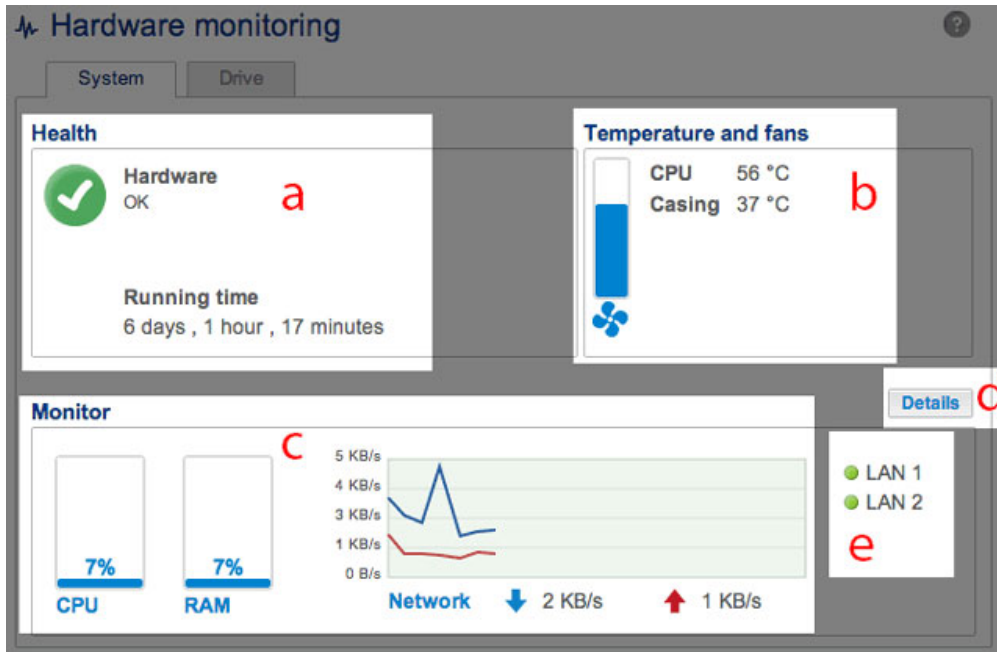

- a: A white check mark within a green circle indicates that your hardware is operational and there are no problems.  
A red circle with a white “X” alerts you to potential problems with the hardware. The red circle is accompanied by an error message, such as the device has reached a critical temperature (see note below).  
The running time indicates consecutive hours and minutes of operation. The clock will restart each time the device is powered on, restarted, or wakes up from deep sleep mode.
- b: Check the temperature of the device's CPU and casing. The line graph measures the average speed of the device's built-in fans. The highest point on the line graph is the fan's greatest speed.
- c: Review the performance meters for the CPU, RAM, and Network.
- d: Choose **Details** to view expanded graphs of the CPU, RAM, and Network meters. Select the pull-down menu to see the performance for each LAN port.

## Monitor details

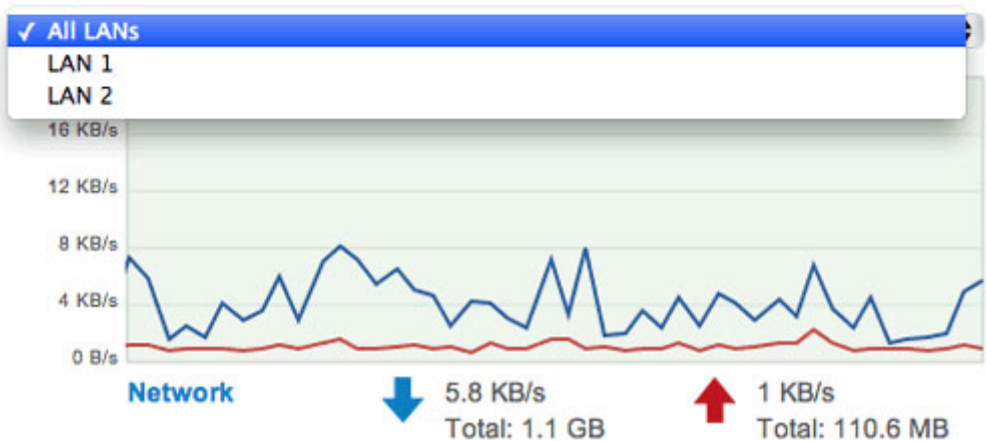
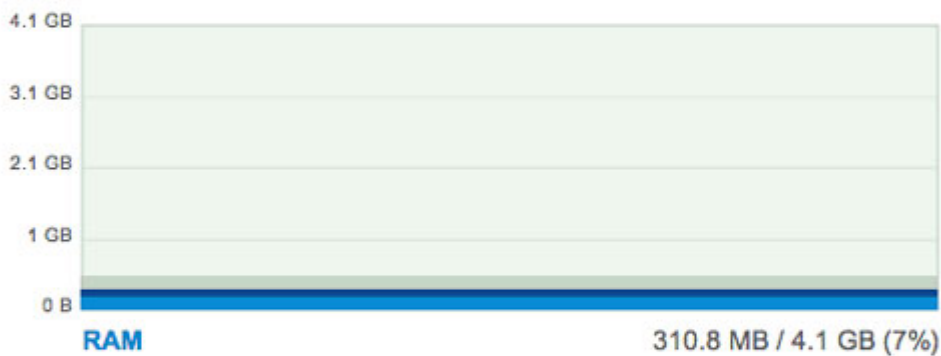
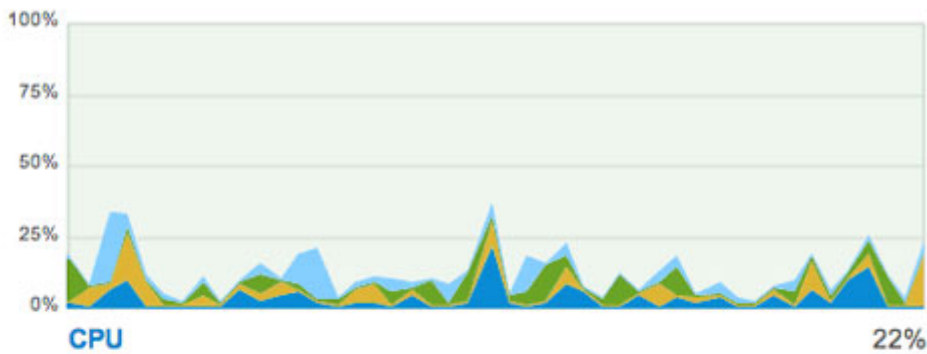

- e: A green circle next to the LAN means that it is connected to the network. A grey circle means that the LAN is not connected to the network.

### Temperature and fans:

- Temperature error: Check the placement of your LaCie to make certain that it is not receiving an abnormal amount of heat from external sources (e.g. sun from a window, heating duct, exhaust from other electronics, etc.).  
If the problem persists, see [Getting Help](#) for links to contact customer support.
- Fan error: Check the fan performance line graph to determine if the fans are running too high or not at all. If the device is overheated as well, follow the directions listed above for a temperature error. Otherwise, see [Getting Help](#) for links to contact customer support.
- Drive error: Select the **Drive** tab to review the status for the LaCie NAS disks. See [Drive tab](#) for instructions on running tests on the disks.

# DRIVE TAB

2big NAS

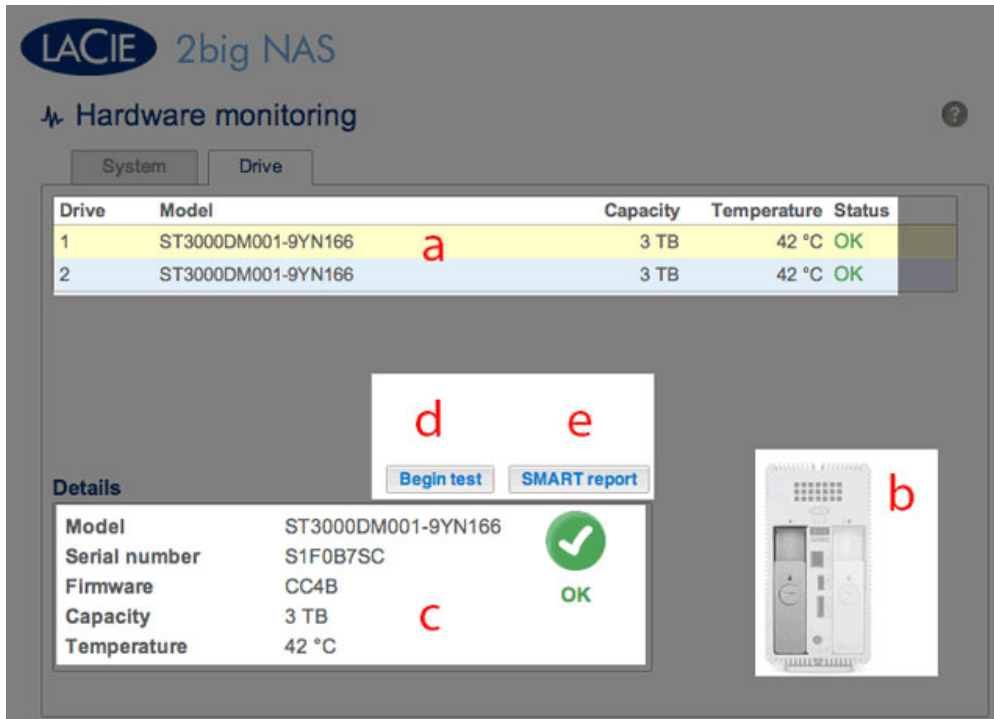

SMART stands for Self-Monitoring, Analysis and Reporting Technology. SMART status should be used for informational purposes only, specifically when diagnosing hard drives.

- a: Review basic information for each disk in the enclosure, including the model number, capacity, temperature, and status.
  - Acceptable **Temperature** values may differ based upon the make and model of the hard disk.
  - **SMART Status** lets you know if the disk is operational or experiencing errors. If the disk has an error, run a SMART test by selecting **Autotest**.
- b: The dynamic photo of your LaCie NAS's backplate will highlight the drive select in the disk pane.
- c: See specific details of the hard disk selected in the disk pane. If the disk has an error, run a SMART test by selecting **Autotest**.
- d: To determine the SMART status, select a hard drive in the disk pane then choose **Autotest**.
- e: Choose **SMART status** to review the details of the selected.

**Hardware monitoring**

System Drive

Drive	Model	Capacity	Temperature	Status
1	ST2000DM001-9YN164	2 TB	42 °C	OK
2	ST2000DM001-9YN164	2 TB	43 °C	OK
3	ST2000DM001-9YN164	2 TB	41 °C	OK
4	ST2000DL001-9VT156	2 TB	39 °C	OK
5	ST2000DM001-9YN164	2 TB	41 °C	OK

**Details**

Model	ST2000DM001-9YN164	 OK
Serial number	W2F0AHR0	
Firmware	CC4B	
Capacity	2 TB	
Temperature	42 °C	

Buttons: **Begin test** (d), **SMART report** (e)

Photo of NAS backplate (b)

SMART stands for Self-Monitoring, Analysis and Reporting Technology. SMART status should be used for informational purposes only, specifically when diagnosing hard drives.

- a: Review basic information for each disk in the enclosure, including the model number, capacity, temperature, and status.
  - Acceptable **Temperature** values may differ based upon the make and model of the hard disk.
  - **Status** lets you know if the disk is reporting or experiencing errors. If the disk has an error, run a SMART test by selecting **Autotest** button.
- b: The dynamic photo of your LaCie NAS's backplate will highlight the drive select in the disk pane.
- c: See specific details of the hard disk selected in the disk pane. If the disk has an error, run a SMART test by selecting the **Autotest** button.
- d: To determine the SMART status, select a hard drive in the disk pane then choose **Autotest**.
- e: Choose **SMART status** to review the details of the selected disk.



# BACKUP

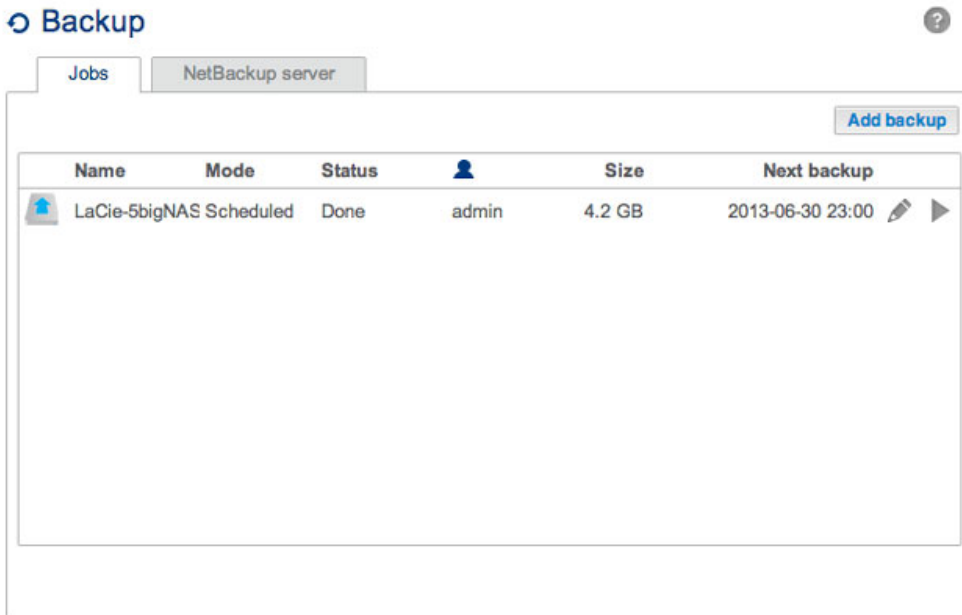

The Backup page helps the administrator configure *Backup and Restore Jobs* of data stored on the LaCie NAS. A job configured on the Backup page can be:

- One-time and/or manual backups.
- An automated backup that runs daily, weekly, or monthly.
- A restore of all or select files from a backup.

For further information on backing up your NAS and instructions on how to create a backup job, go to [Backup Jobs](#).

**Important info on NAS backup:** It is recommended that all users back up data to DAS or another NAS as further protection against disk failure or secondary points of failure (e.g. hardware, network, etc.) See [Backup Jobs](#) for details.

# EXTERNAL PORTS



## External ports

### USB printer

Activate the printer server

Printer name                      Printer cannot be found

### External drives

External drives	Size	Used storage	Mounted on	Bus	
LaCie_4big	4 TB	<input type="text" value="0%"/>	LaCie_4big (esa...	eSATA	<input type="button" value="Eject"/>

This page provides you with information on devices connected to one of the LaCie NAS's USB or eSATA expansion ports.

Port	LaCie 2big NAS	LaCie 5big NAS Pro
eSATA	1	-
USB 2.0	1	2
USB 3.0	-	2

## USB PRINTER

## External ports

### USB printer

Activate the printer server

Printer name Deskjet-6980-se...

Deskjet-6980-series

### External drives

External drives	Size	Used storage	Mounted on	Bus	
LaCie_Hard_Drive	2 TB	<input type="text" value="0%"/>	LaCie_Hard_Driv...	USB	<input type="button" value="Eject"/>
LaCie_4big	4 TB	<input type="text" value="0%"/>	LaCie_4big (usb...	USB	<input type="button" value="Eject"/>

Your LaCie NAS features a printer server. Follow the directions below to connect your printer to the network via the LaCie NAS:

1. In **Dashboard > External ports**, confirm that the box next to **Activate the printer server** is checked.
2. Power on the printer and connect it to a USB expansion port on the rear of your LaCie NAS.
3. Once connected, the printer will be listed and available throughout your network.

Please note that computer(s) on your network may require specific drivers to use the printer. See the user manual for your printer for details.

**Important info:** For multi-function printers, only the print feature is supported. If your printer has a scan feature, for example, it will not work when connected to the LaCie NAS.

In addition, only PostScript printers are supported. If your printer does not display on **Dashboard > External Ports**, it is likely that the printer does not support PostScript printing. This is frequently the case with multi-function and photo printers. LaCie cannot guarantee that your printer supports the proper protocols to make it a networked printer.

## EXTERNAL DRIVES

### Connect

Connect an external hard drive to the LaCie NAS via either USB or eSATA, and it will be listed on this page. Once connected, an external hard drive acts as a share on your LaCie NAS. It will be listed at **Dashboard > Shares** and can be accessed using your operating system's file system (Explorer Window for Windows users, and Finder for Mac users). Please note that connected external hard drives are public shares on the network and their names cannot be changed.

**Technical note:** External USB or eSATA hard disks must be formatted in one of the supported systems to be compatible with your LaCie NAS: MS-DOS (FAT32), NTFS, HFS+ (non-journaled only), EXT3, or XFS.

## Disconnect

To avoid damaging your external hard drive's file system, click the **Eject** button before disconnecting it from your LaCie NAS.

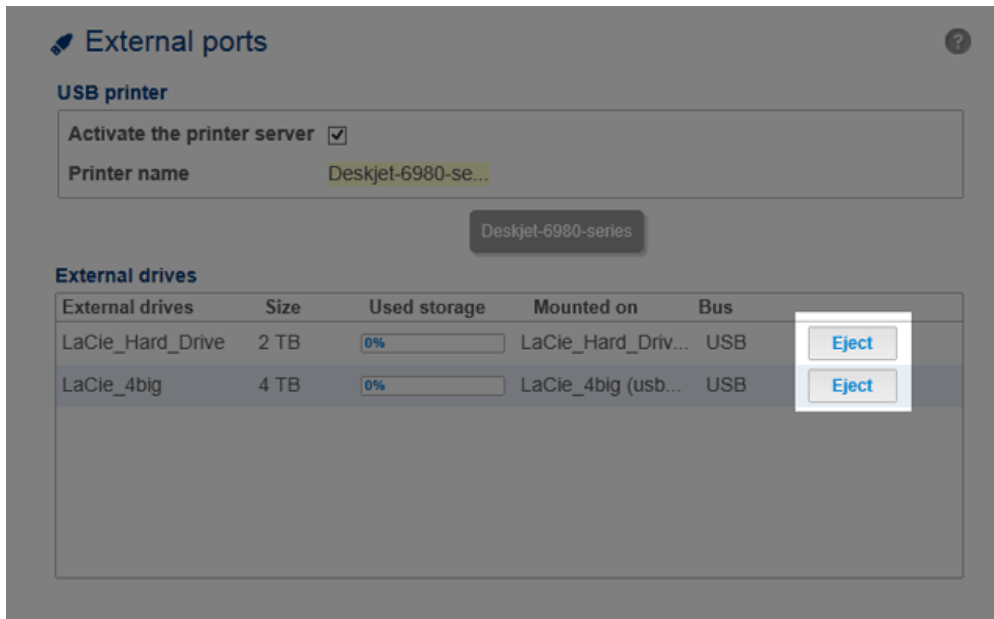



## MULTIMEDIA INDEXING

You can take an inventory of available multimedia files on your LaCie NAS and all connected external hard drives. See [Reindex the Media Server](#) for details.

# DOWNLOAD MACHINE

↓ Download Add download Start  

The download machine is not running. No further information is available.

TCP Listening port 51413   Unlimited   Unlimited   5 

The LaCie NAS Dashboard features a download server that allows you to download files from the internet or the local disk (e.g. PDF, torrent, binary, etc). For more information on torrents, see [http://en.wikipedia.org/wiki/BitTorrent\\_protocol](http://en.wikipedia.org/wiki/BitTorrent_protocol).

## CREATE A DOWNLOAD

1. If the download service has not been turned on, choose the **Start** button.
2. To initiate a download, choose the **Add download** button.

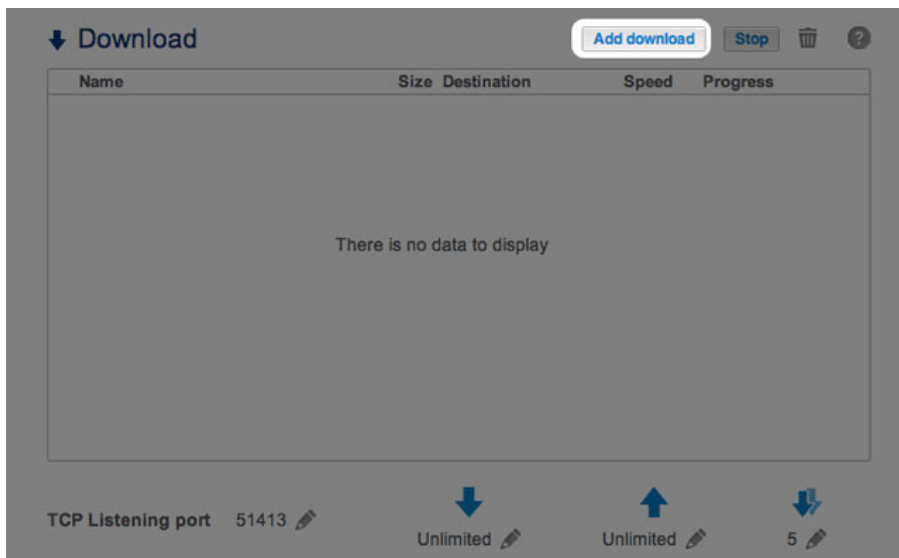

3. At the prompt, choose whether the file source can be found at a **URL** (web address) or if it is a **Local File**.
  - URL: Type or paste the web address.

### Add download

Source :

URL  Local file

Destination : 

**Download: URL radio button**

### Add download

Source :

URL  Local file

Destination : 

**Paste the URL address**

- Local File: Select **Browse** to search for the file.

### Add download

Source :

URL  Local file

Destination : 

#### **Download: Local File radio button**

- Select the **Destination** share by clicking on the configuration icon (pencil).
- To better organize your downloads, you can choose **Create folder** at the prompt to add a folder to the share.

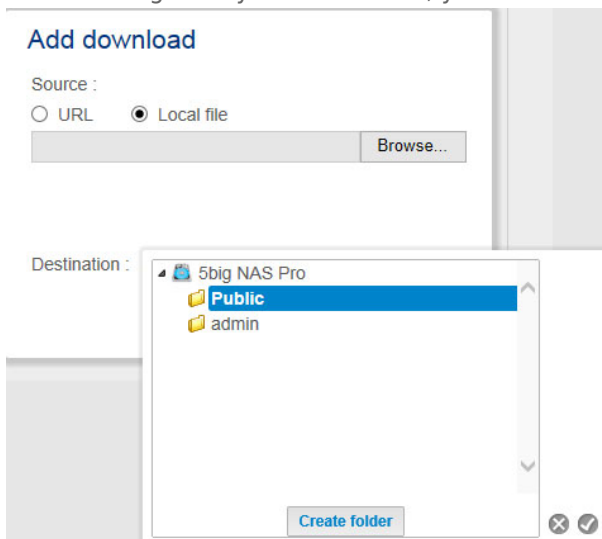

#### **Create a folder to organize your downloads**

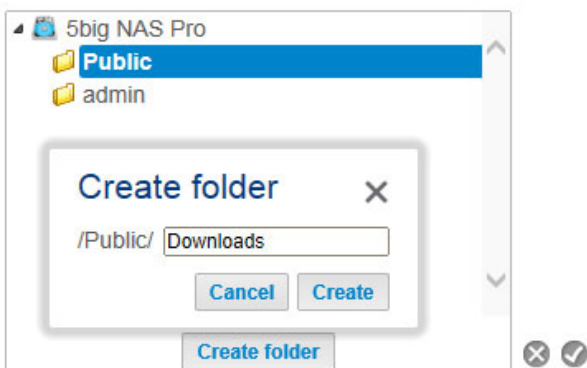

#### **Name the folder for your downloads**

- Choose **Apply** to begin the download.

## Add download

Source :

URL     Local file

C:\Users\David\Desktop\pg books - sense a Browse...

Destination : /Public/Downloads/Local 

Cancel Apply



## DOWNLOAD PAGE SETTINGS

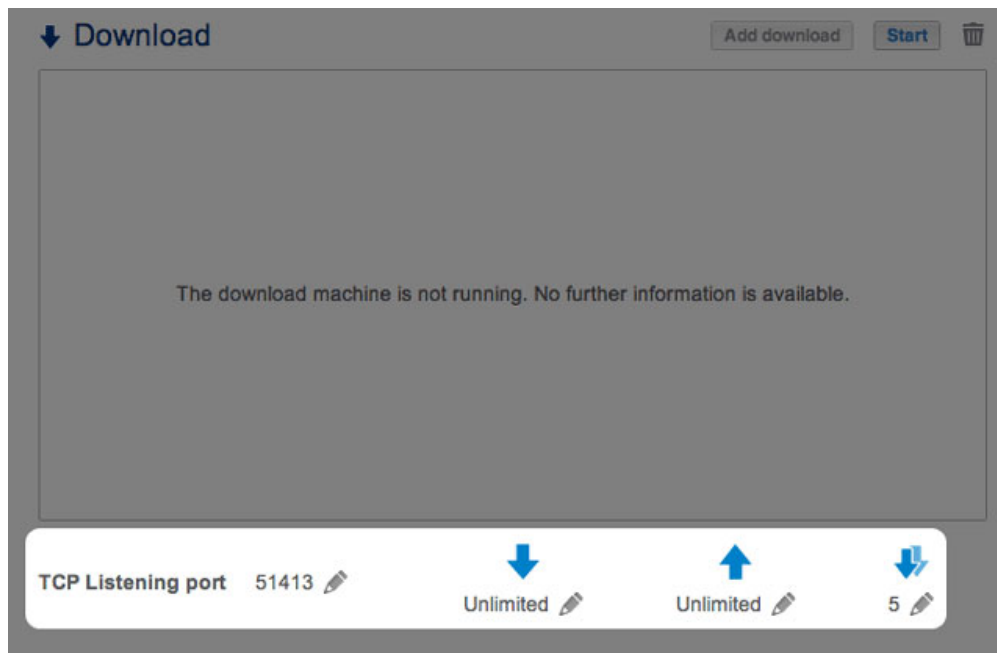

Below the list of downloads are several settings.

- **TCP Listening port:** Choose the configuration icon (pencil) to enter a router port number through which the download service will operate.
- **Download rate limit (down arrow):** Choose the configuration icon (pencil) to type a maximum download speed.
- **Upload limit rate (up arrow):** Choose the configuration icon (pencil) to type a maximum upload speed.
- **Max. active downloads (two down arrows):** Choose the configuration icon (pencil) to limit the number of downloads that can download/upload simultaneously. Type zero for no limit.

**Technical note:** Multiple simultaneous downloads can impact your LaCie NAS's performance. In some instances, even after a download has completed, the download service may continue to use system resources if it is uploading.

# STORAGE

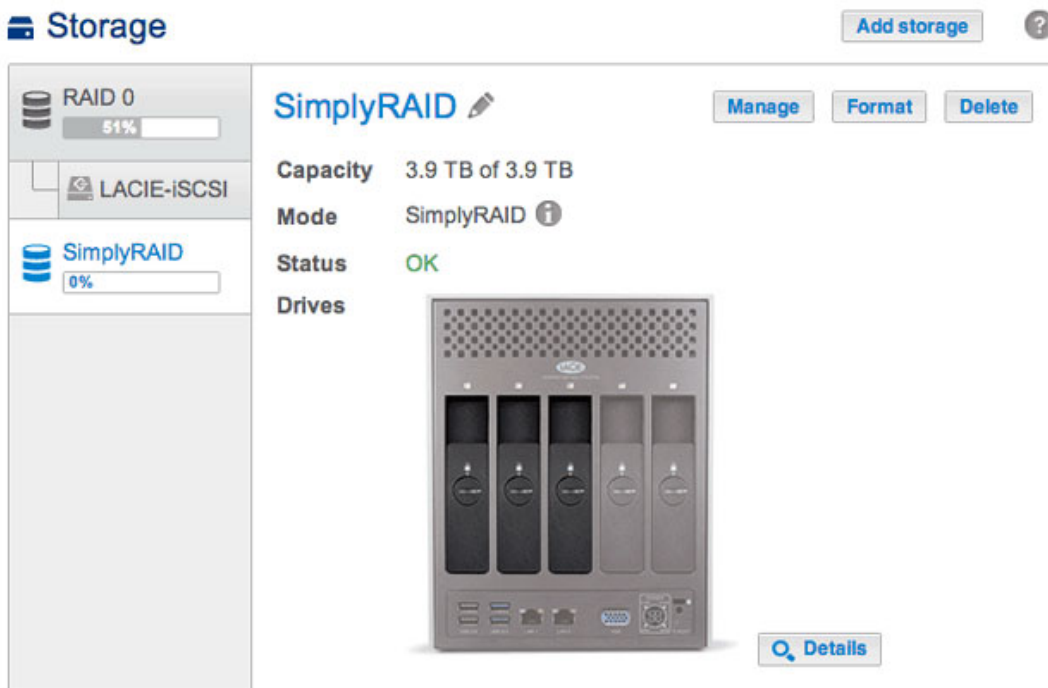

The information below identifies and explains the functions on the Storage page. For directions on how to configure RAID for your LaCie NAS, select product below:

- [LaCie 2big NAS](#)
- [LaCie 5big NAS Pro](#)

**Manual note:** Certain features and functions listed below apply only to the LaCie 5big NAS Pro, such as LaCie SimplyRAID, RAID 5, RAID 6, spare disks, and double-disk security.

# LACIE NAS VOLUME AND RAID MANAGEMENT

Your LaCie NAS can have up to five volumes, each with its own level of RAID.

## Enhanced data protection: LaCie SimplyRAID

No matter the capacity of your disks, LaCie SimplyRAID will prepare the storage for immediate use as well as future expansion. LaCie SimplyRAID allows you to:

- Install disks of varying capacities (1TB, 2TB, and 3TB)
- Replace smaller capacity disks with larger capacity disks
- Upgrade storage capacity without deleting or moving data
- Protect data without compromising performance

When using disks of varying capacities, LaCie SimplyRAID will attempt to optimize available storage for your data.

## Standard disk configuration: Manual RAID

While the benefits of LaCie SimplyRAID are highly recommended, the Storage page also gives you the option to manually configure your hard disks as:

- JBOD
- RAID 0 (minimum two disks)
- RAID 1 (minimum two disks for data protection)
- RAID 5 (minimum three disks)
- RAID 5 plus spare (minimum four disks)
- RAID 6 (minimum four disks)
- RAID 6 plus spare (minimum five disks)

## REVIEW AND REVISE THE STORAGE SETTINGS

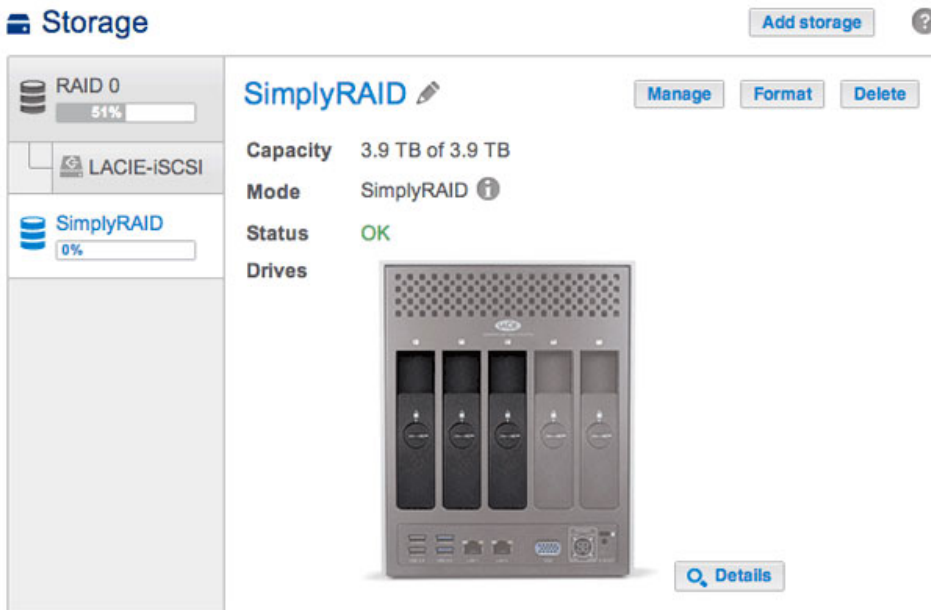

The initial view for the Storage page displays the volume(s) and current RAID scheme(s) for your LaCie NAS. Use this page to add, manage, and configure the NAS storage.

### Select a volume

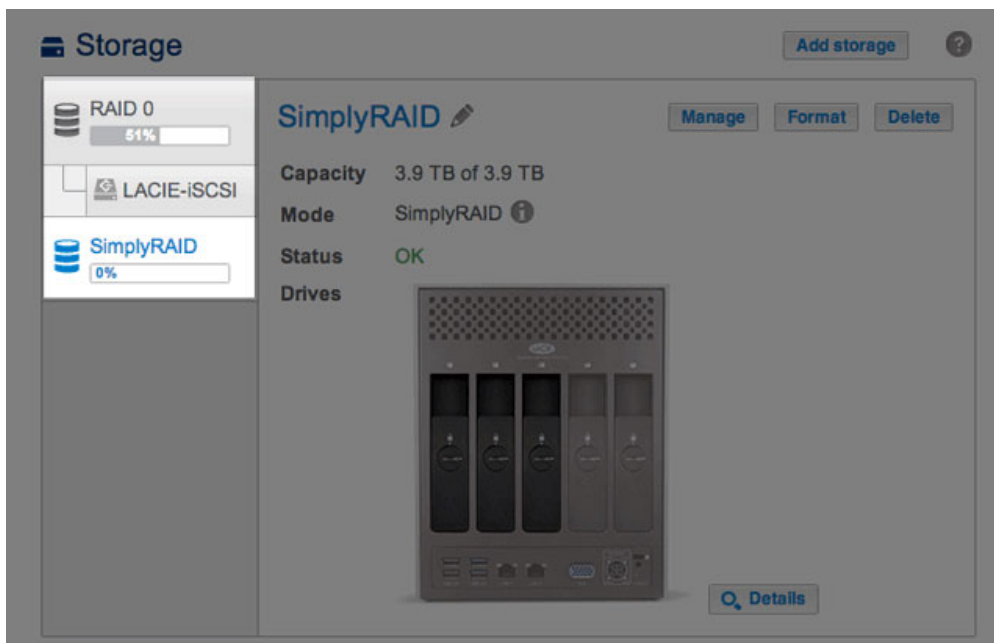

Choose a volume within the left-hand column. The selected volume will appear in white while the other volumes are grey.

## Volume tools



Tools to manage the selected volume are available in the center of the Storage page.

Name

The default name for the first new volume is *Volume 1*. The number will rise incrementally when adding new volumes, *Volume 2*, *Volume 3*, etc. To change the name:

1. Choose the configuration icon (pencil) next to the name.

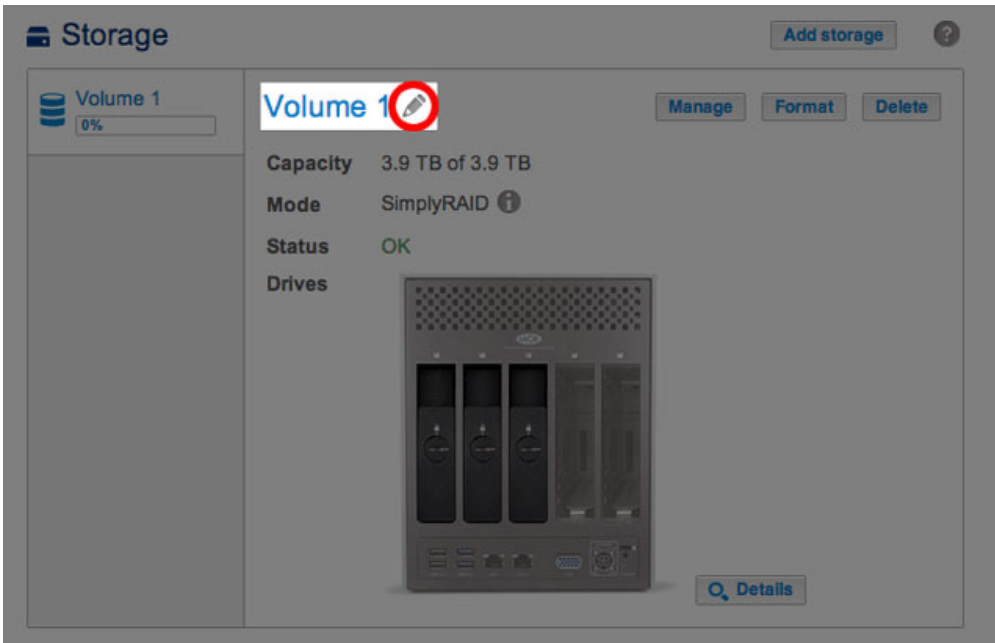

2. Select the default name to type the new name.

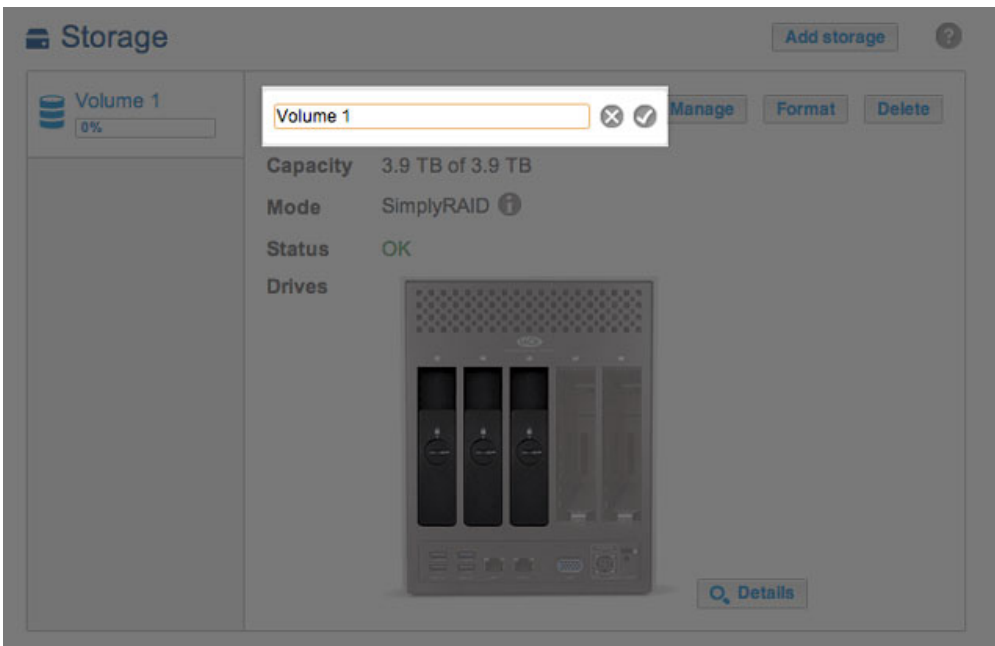

3. Once the new name is entered, choose the check mark.

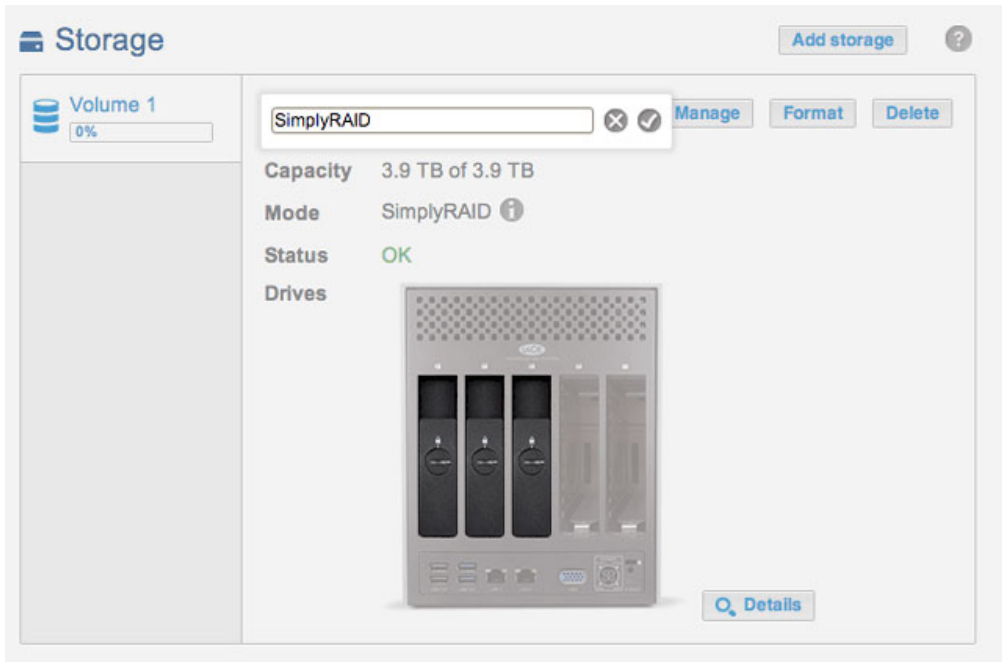

## Capacity

A quick reference of the volume's:

- Total storage capacity.
- Available storage capacity.

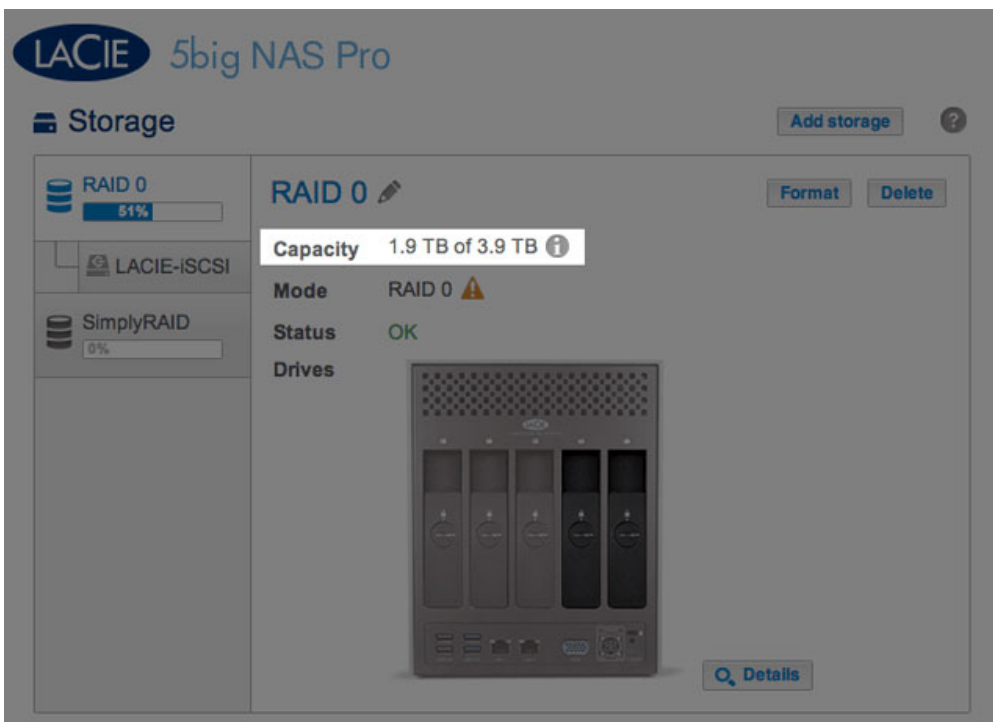

The *i* tooltip will appear in the row for capacity following the creation of an iSCSI target. In the example below, passing the cursor over the tooltip indicates the amount of storage assigned to the volume's iSCSI target.



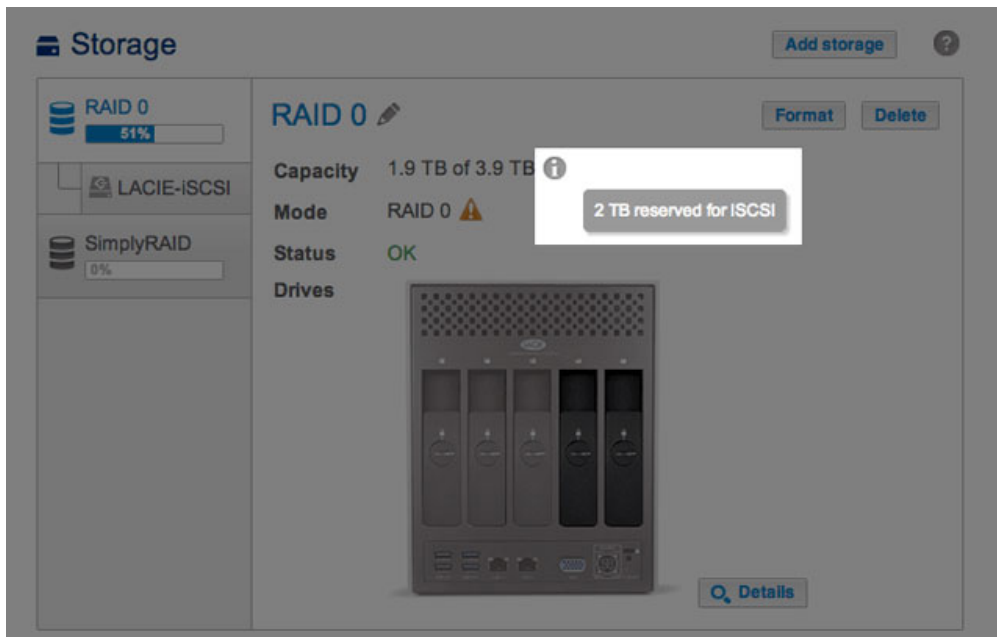

Mode

**Mode** lists the level of RAID configured for the volume. A tooltip is available next to the volume's RAID level:

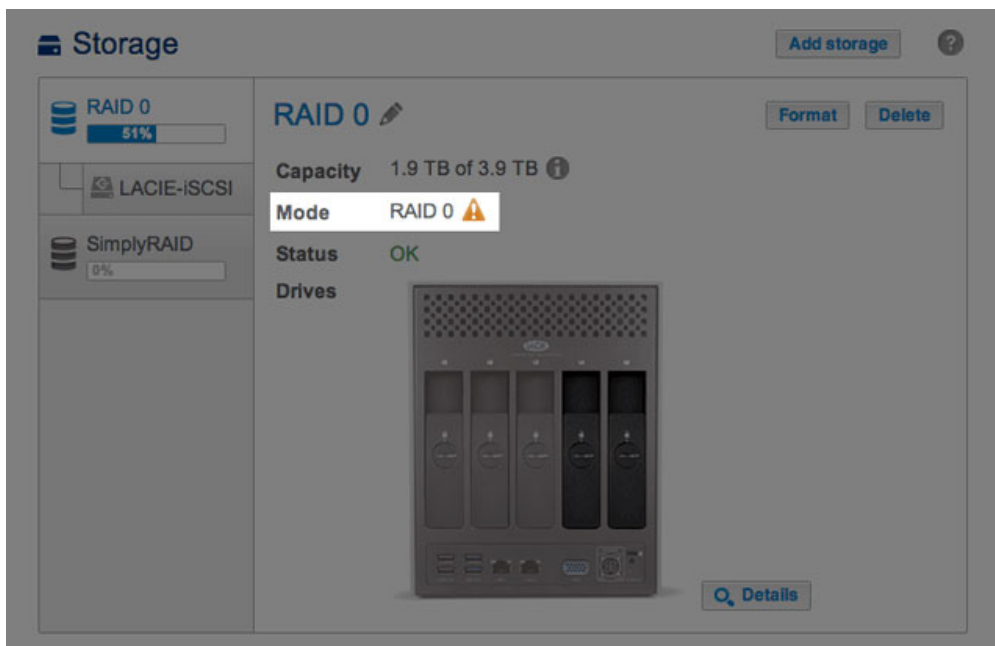
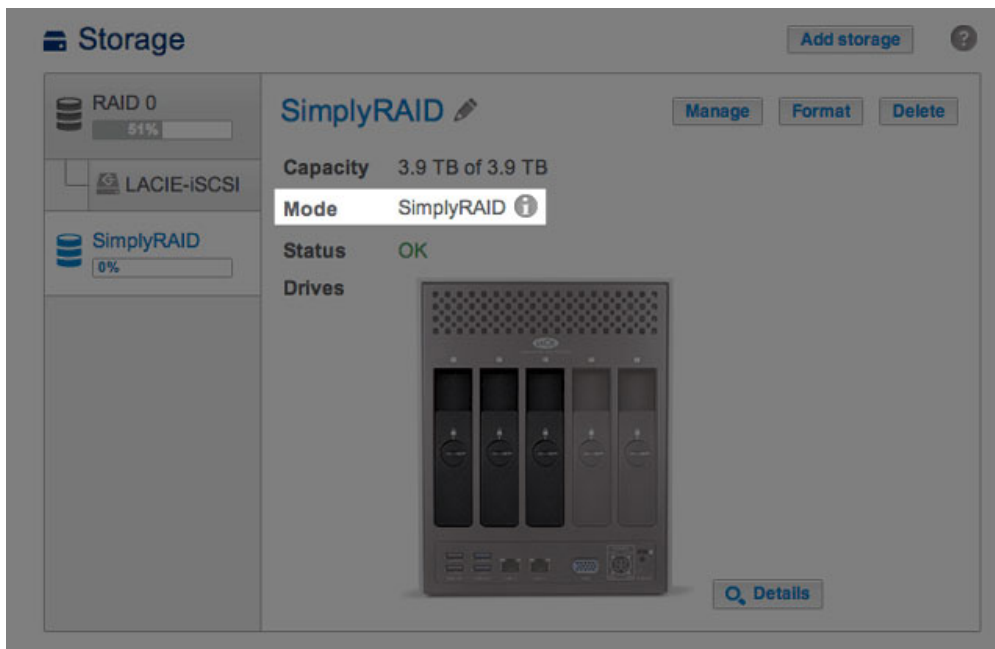

Pass the cursor over the tooltip for important information about the RAID's level of data protection.

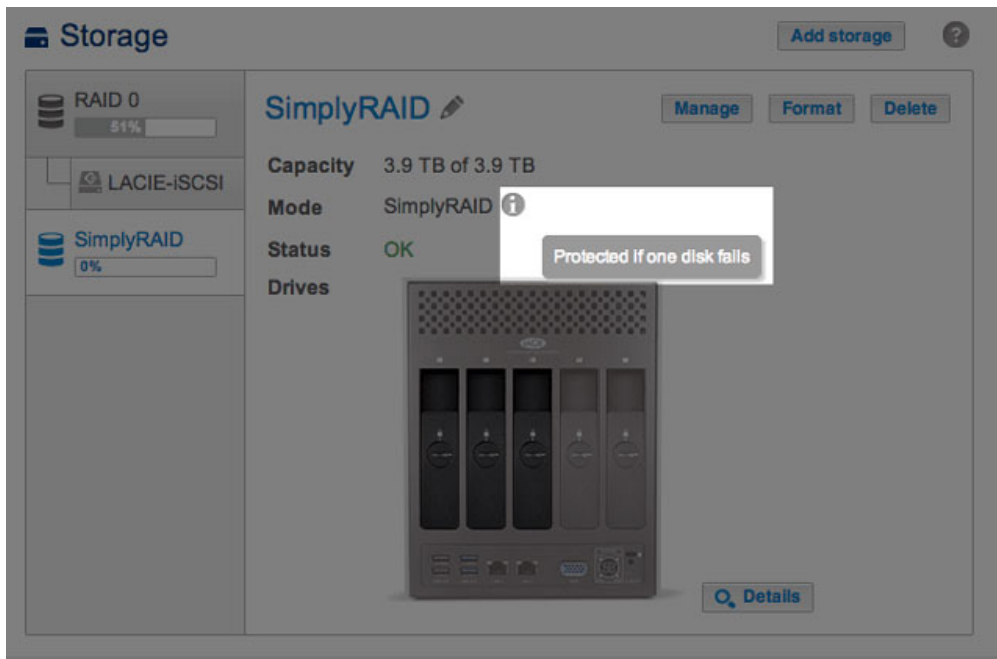

Status

**Status** gives you immediate feedback on the health of the volume's RAID configuration:

- **OK.** The standard message in most instances, indicating that the RAID is operational and that no problems have been detected.

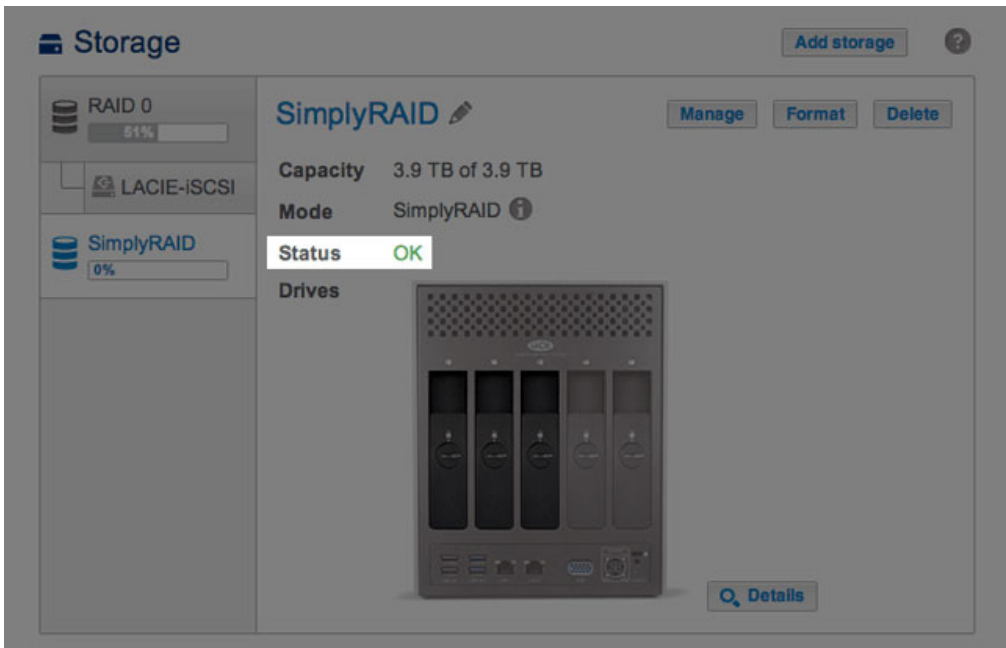

- **No data protection.** Data on the volume is intact but the RAID is in danger of breaking since one or more disk(s) are missing or reporting errors. The amount of disks that can fail before this message appears is contingent upon the level of RAID (see [5big\\_NAS\\_Pro: About RAID Modes](#) for further information.)

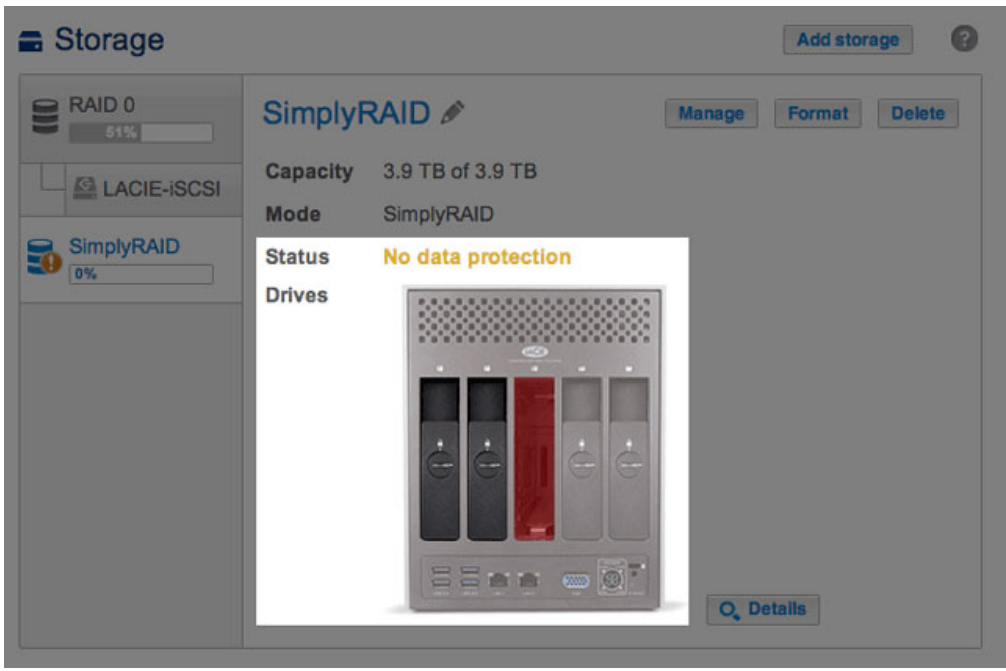

- **Protected if one disk fails.** RAID configurations with double-disk security will see this message if a single disk is missing or reporting errors.

Storage

Add storage ?

RAID\_6 0%

RAID\_6

Manage Format Delete

Capacity 2.9 TB of 2.9 TB

Mode RAID 6

Status Protected if one disk falls

Drives

Details

- **Broken.** The RAID is broken resulting in a loss of data.

Storage Add storage ?

RAID 0 51%

LACIE-iSCSI

SimplyRAID 0%

RAID 0

Format Delete

Capacity 1.9 TB of 3.9 TB ⓘ

Mode RAID 0

Status Broken RAID

Drives

Details

**Broken RAID 0: One is disk missing**

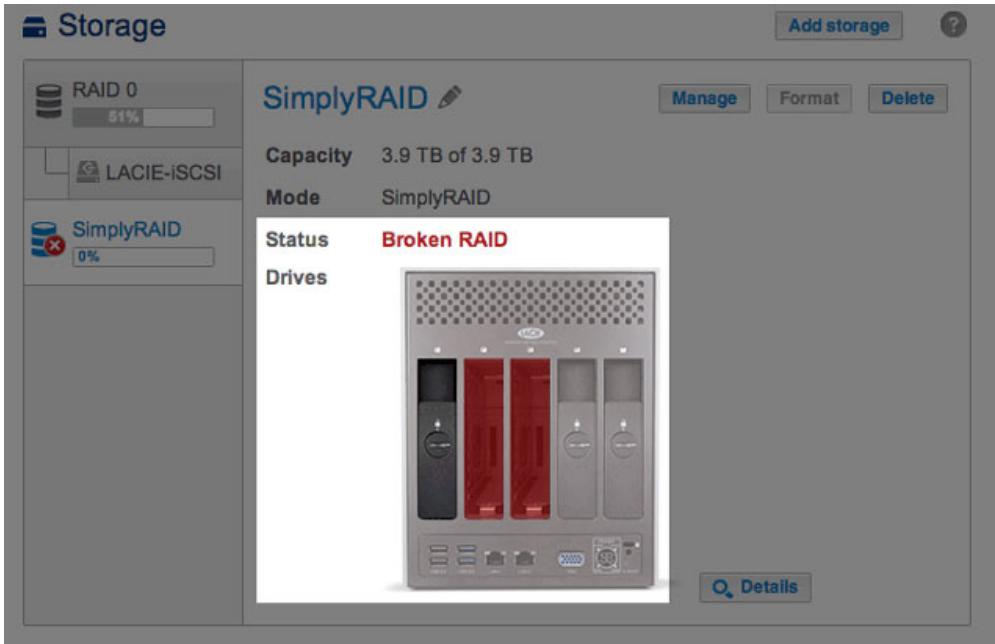

**Broken SimplyRAID: Two disks are missing**

- **Synchronizing.** The system is synchronizing data across all the disks selected for the RAID configuration. The volume is available for use while the RAID is synchronizing.

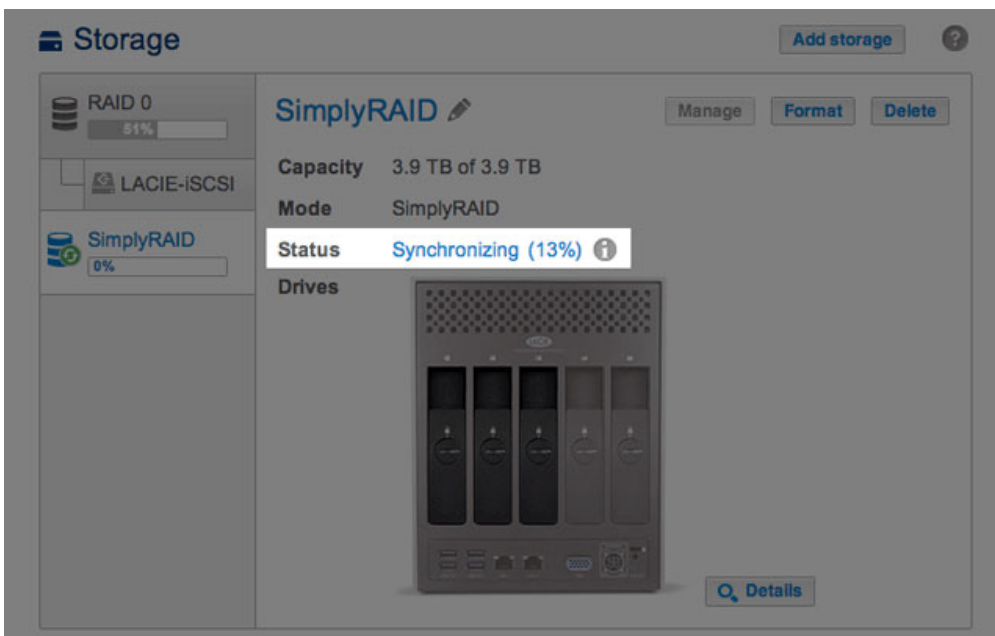

Choose **Details** for further information.

Details

Choosing **Details** opens a popup window with information that complements the message within **Status**. When the **Status** is *OK*, a multicolor bar shows how LaCie SimplyRAID or standard RAID distributes the volume's storage.

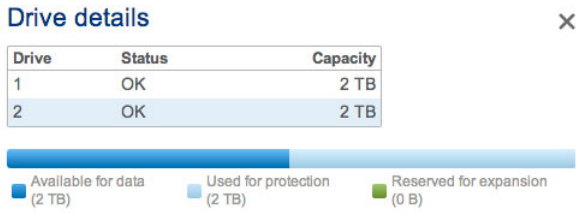

**RAID Status: *SimplyRAID***

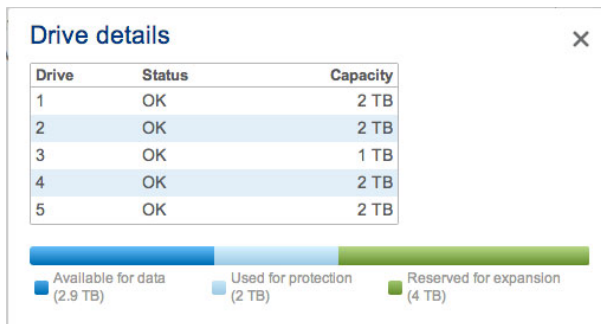

**RAID Status: *RAID 6***

- Dark blue: Storage capacity for your data.
- Light blue: Protection in case one or two disks fail. The light blue indicator will vary in size depending upon single or double disk protection.
- Green: Disk capacity that spans beyond the level of RAID. This space is reserved for expansion should you add new or, larger capacity disks.

**Status** messages *Broken*, *Protected if one disk fails*, and *Synchronizing* are also listed in the Details popup window.

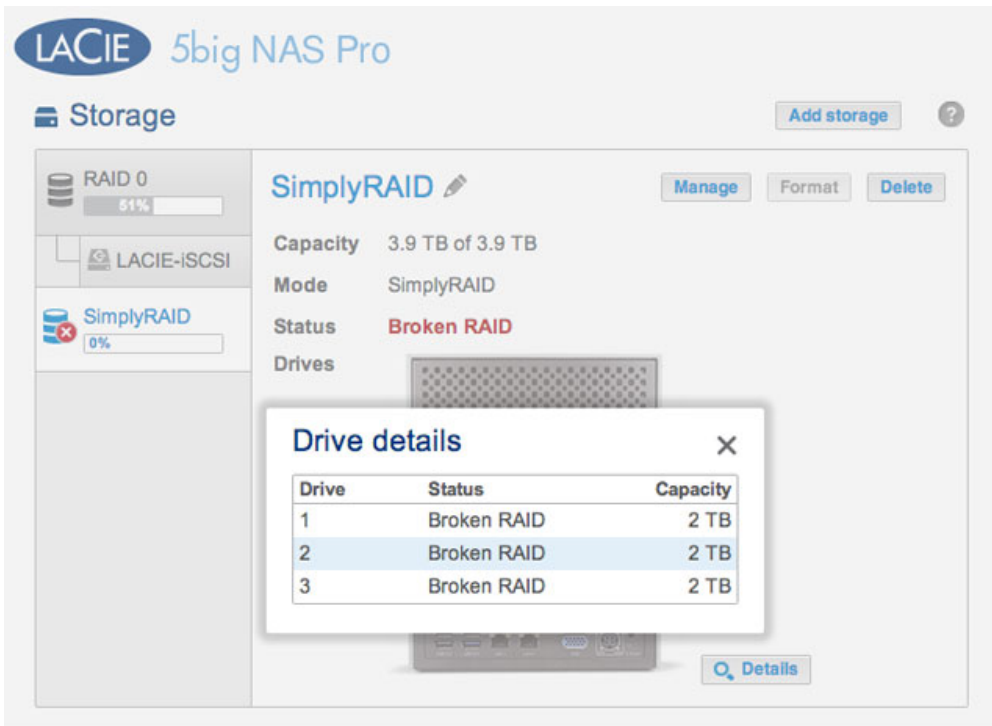

**RAID Status: SimplyRAID Broken**

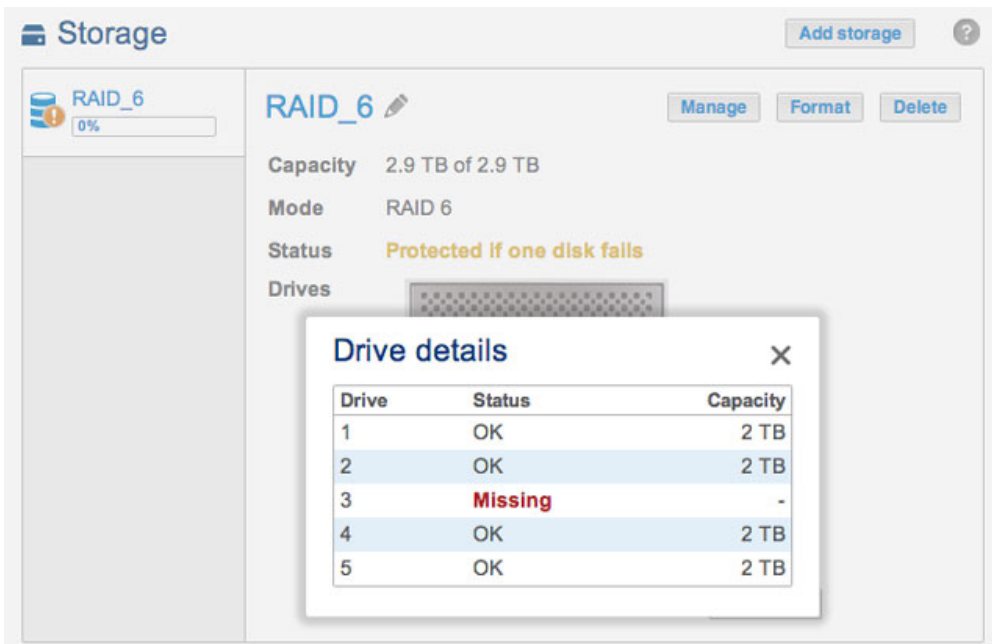

**RAID Status: RAID 6 Single-disk protection**



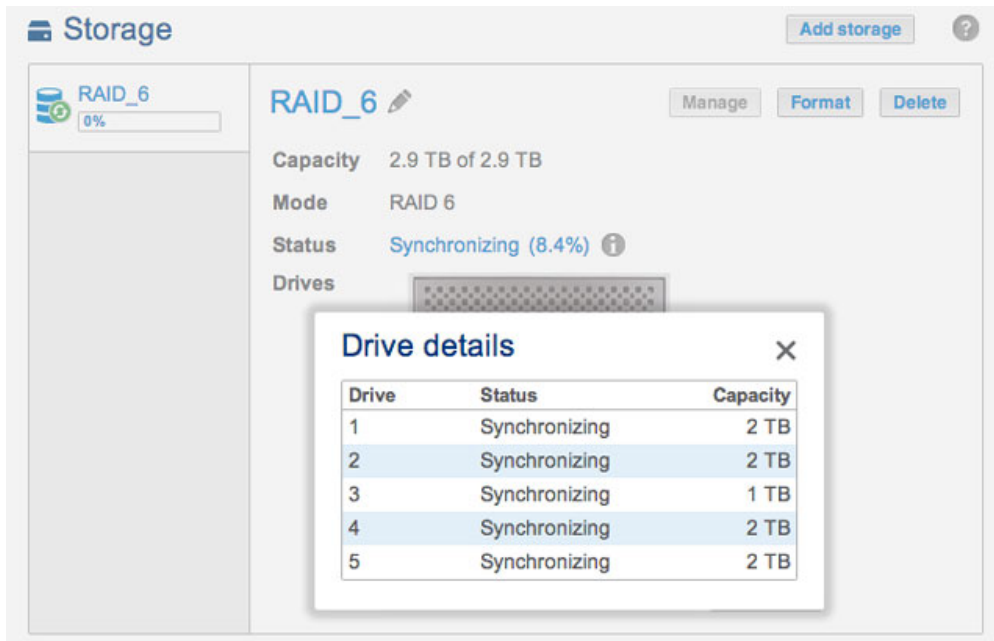

**RAID Status: Synchronizing RAID 6**

## Add storage

Choose **Add storage** to create new volumes and iSCSI targets. For further information, see:

- [New volume wizard: 2big NAS](#)
- [New volume wizard: 5big NAS Pro](#)
- [iSCSI Target](#)

## Manage

You can perform the following on a volume using **Manage**:

- Add disks
- Repair
- Expand storage capacity
- Upgrade from single-disk security to double-disk security

## Format

Select **Format** to **delete all shares and data on a volume**. Make certain to back up your data before choosing **Format**.

Though data is deleted, the RAID configuration for the volume will remain intact. Since you do not have to rebuild the RAID, this is a good alternative to **Delete** when you want a simple option to deleting all data on the volume.

## Delete

Choosing **Delete** will **DELETE THE VOLUME AND ALL OF ITS ASSOCIATED SHARES AND DATA**. Use the **Delete** button only if you intend to recreate the RAID from scratch and/or add disk(s) to another volume.

## Drive

The dynamic photo of the LaCie NAS backplate highlights:

- The disks associated with the volume selected on the left-hand column.

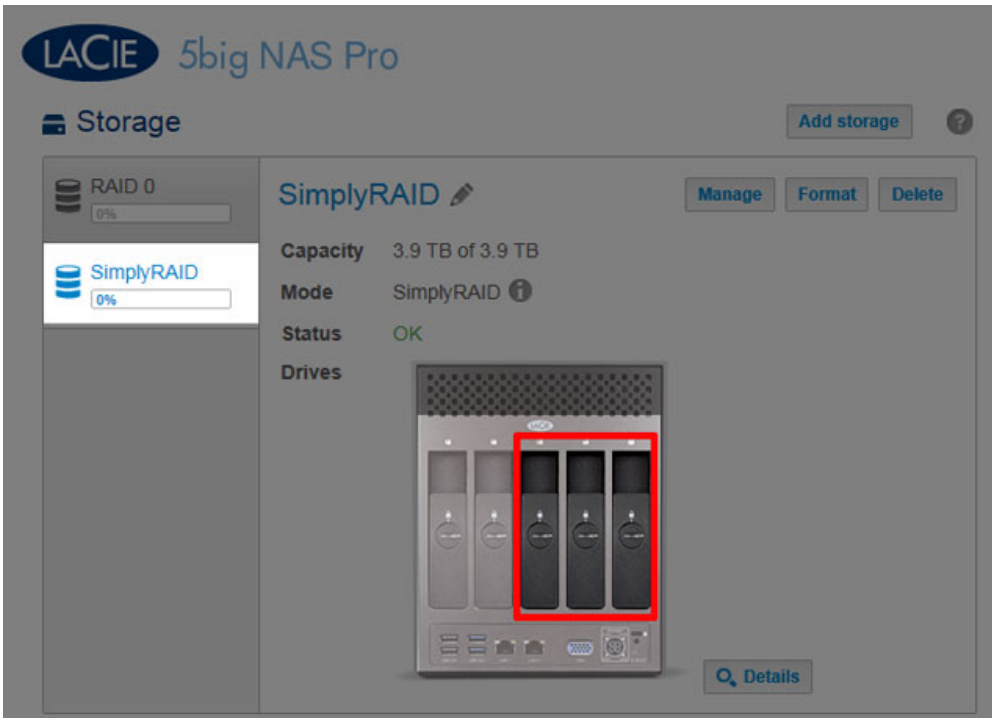

**Disks in the volume**

- New disks available for a new or existing volume.

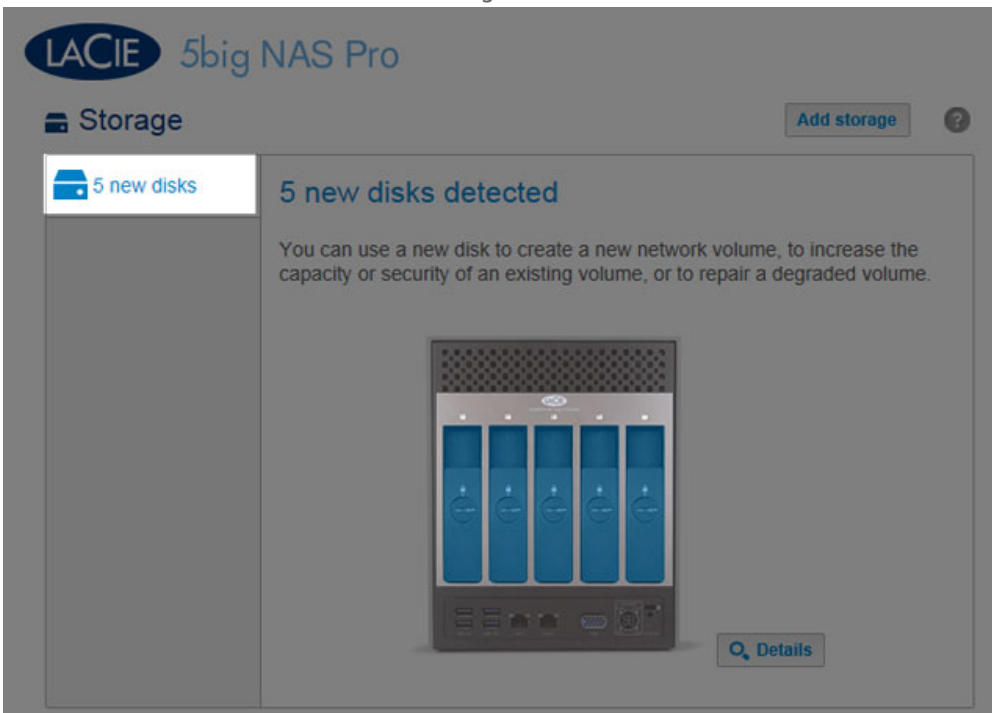

**New disks**

- Empty slots available for expansion.

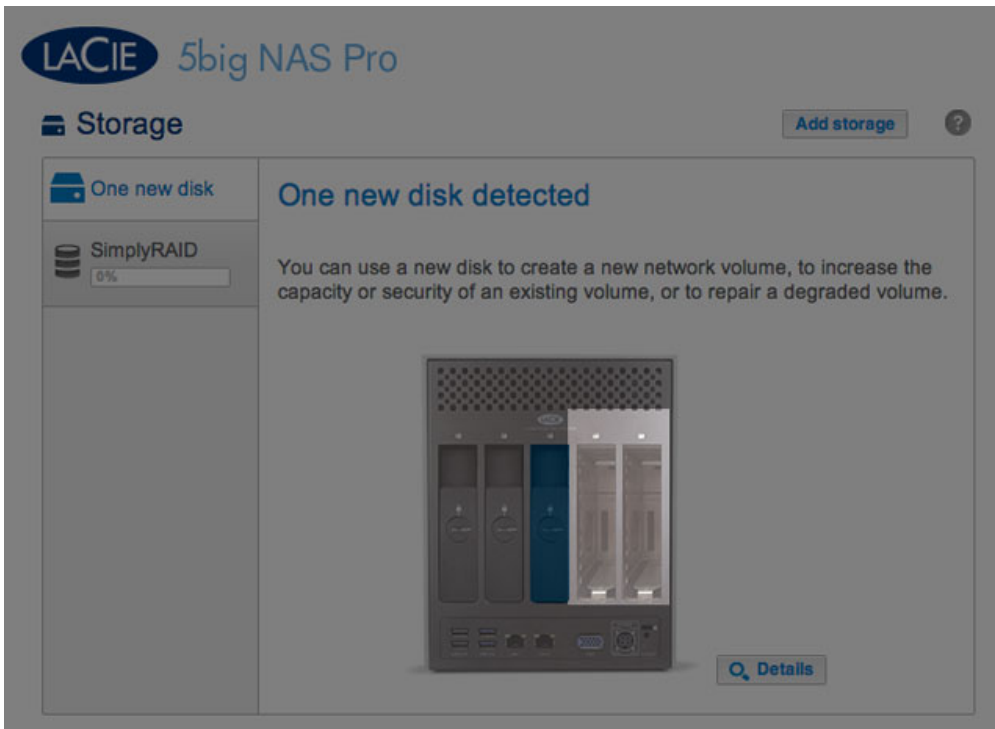

**Empty slots**

- Failed or missing disks.

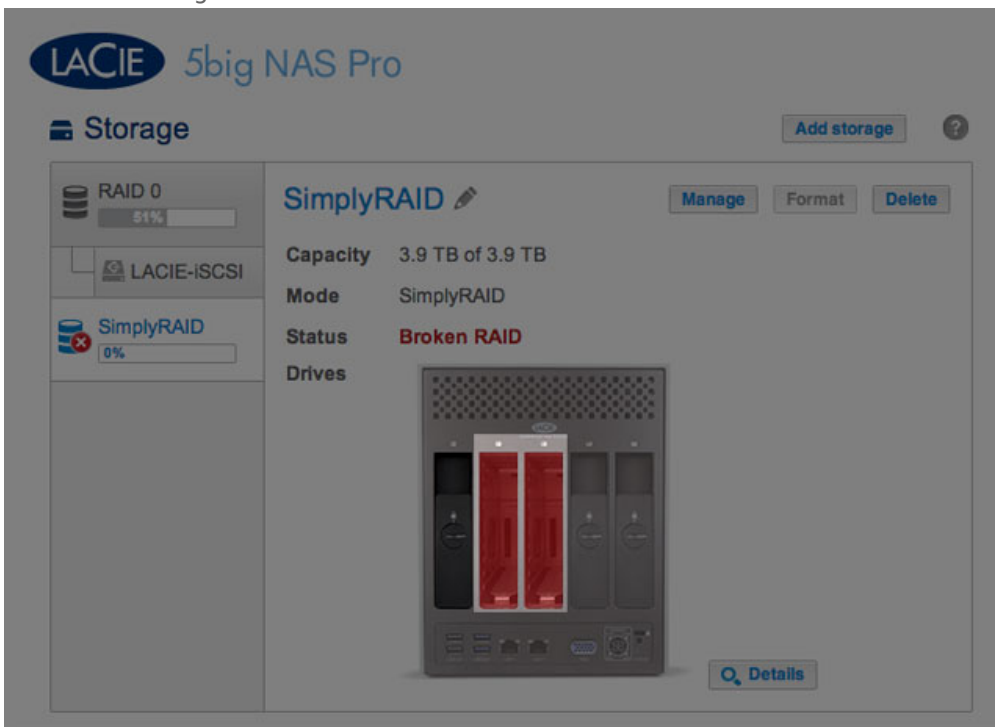

**Missing disks**

## Storage capacity and distribution

Factors that determine the storage capacities for data, protection, and expansion:

- The amount of disks in the enclosure
- The storage capacity of each disk (see note below on mixed capacities)
- RAID mode
- Single-disk or double-disk security

Examples:

- **RAID 0 configuration with five disks.** The only color is dark blue for data capacity since RAID 0 has no protection.

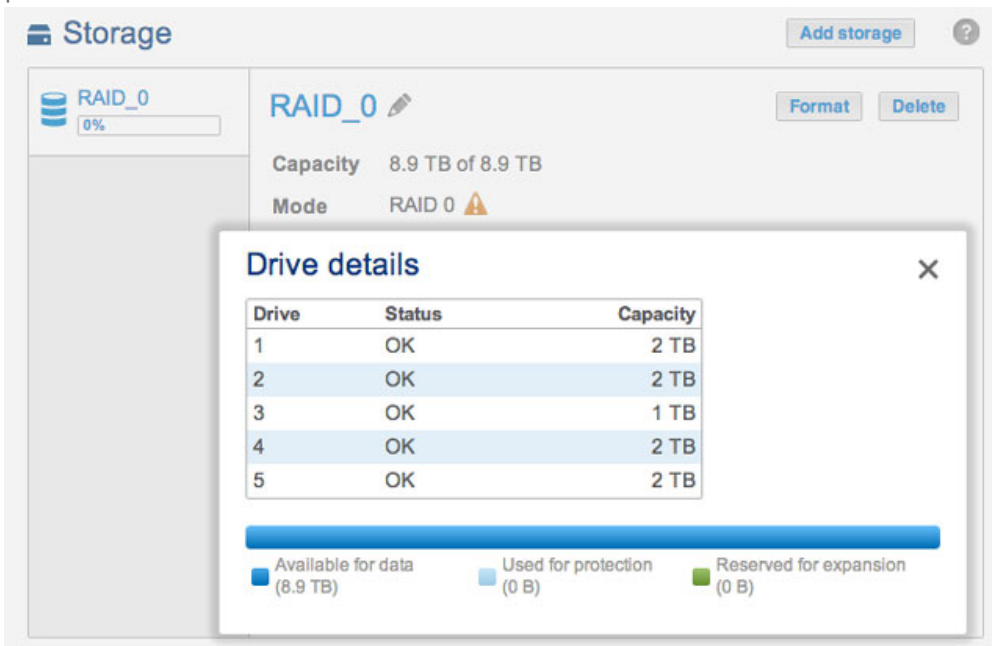

### **RAID 0: Five disks**

- **LaCie SimplyRAID configuration with two disks.** Dark and light blue for data and protection, respectively. Both disks are the same capacity.

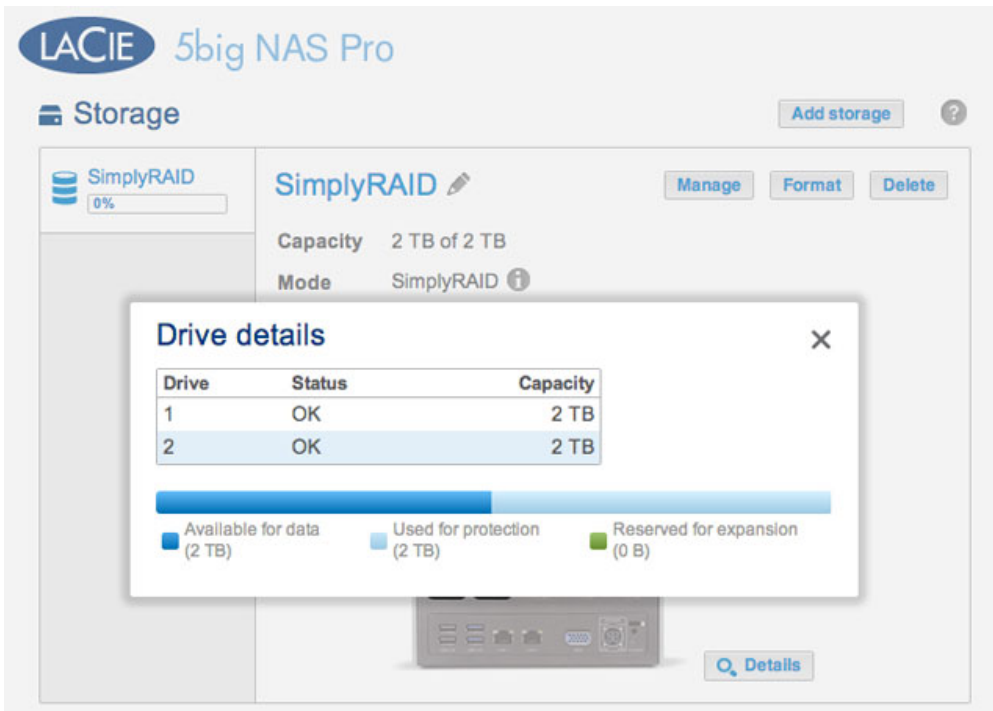

**SimplyRAID: Five disks**

- **RAID 6 configuration with five disks.** All colors are represented since the RAID 6 uses double-disk security and the disks are of mixed capacities.

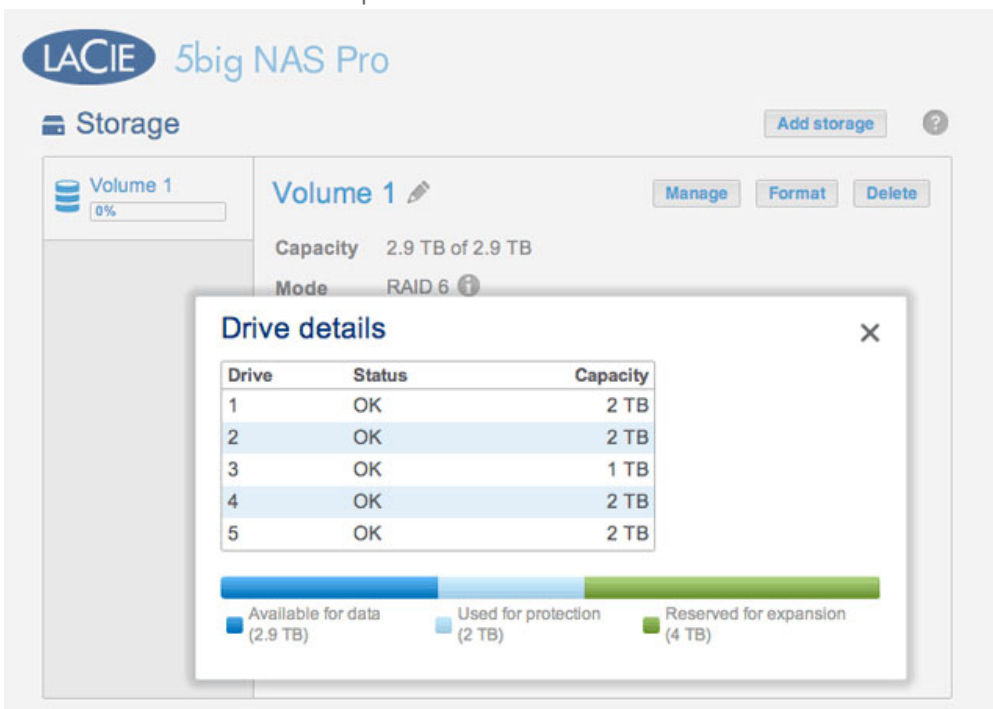

**RAID 6: Five disks**

# DRIVE INFORMATION & ISCSI SETUP

**Drive Information**

Drive size 3 TB

Formatted size 3 TB

	Capacity	Used	Available	Used storage
Network drive	3 TB	211.8 MB	3 TB	<input type="text" value="0%"/>
iSCSI Drive	0 B	0 B	0 B	<input type="text" value="0%"/>

This page shows you information about disk usage and will allow you to reformat your disk(s).

When you click the top **Format** button, ALL data on the disk(s) (including an iSCSIshare) will be erased and the disk(s) will be formatted for LaCie NAS OS. Data on any hard drive connected to the expansion ports will not be affected.

To reformat:

1. Click the **Format** button.
2. In the window that opens, confirm by clicking the **Format** button.

## Format Drive



Formatting the device will erase all data stored on the hard drive (iSCSI included).

Choose Cancel if you do not wish to format the device.



Cancel

Format

**Caution:** Formatting will erase all the data on your drive (but will not remove users or settings). Make sure to back up all your data onto another volume before proceeding. LaCie cannot be held responsible for the loss of data.

# CONFIGURE ISCSI

You can configure your LaCie NAS share as an iSCSI target client, which allows you to mount a network share as a local volume. You can then format this volume in a non-network file system such as NTFS, HFS+, or FAT32.

Please note that **the maximum capacity for an iSCSI volume is 8TB.**

Follow the directions below to allocate a portion of the LaCie NAS's storage to **iSCSIShare**:

1. Click the configuration icon (pencil) in the iSCSIShare row and then select **Resize iSCSI**.

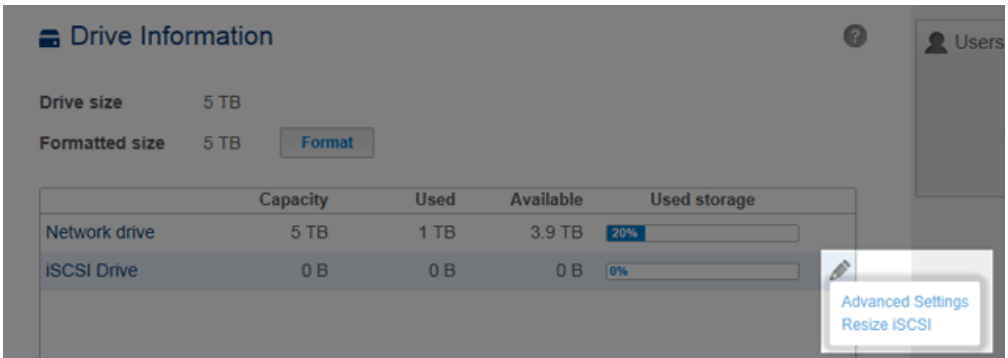

2. Drag the slider to change the amount of space allocated to the iSCSI Drive. After you click the slider, press the right and left arrow keys on your keyboard to fine tune.

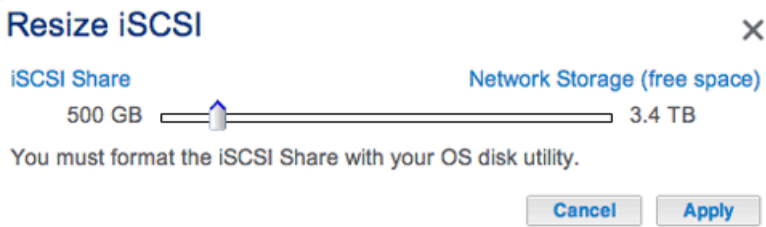

3. Click the **Apply** button, then confirm in the popup window.
4. You will need to format the share using your operating system's disk management utility (Disk Utility for Mac and Disk Management for Windows).
5. Install and configure an iSCSI client initiator from Microsoft (Windows users) or a third party vendor. Refer to the vendor's documentation for details.



**Important info on resizing error:** At times, **Dashboard > Drive** may display a resizing error with iSCSI volumes equal to or greater than 1.5TB. The error can appear when the administrator creates/expands an iSCSI volume or reduces an existing iSCSI volume to 0TB. Please note that, in almost all instances, the error is not correct and that the changes to the iSCSI volume have been applied.

The screenshot shows the 'Drive Information' page for a LaCie 2big NAS. At the top left is the 'LACIE 2big NAS' logo. At the top right, there is a warning message: '2013-01-17 11:58 Error resizing iSCSI'. Below the logo, the page title is 'Drive Information'. Underneath, it shows 'Drive size 3 TB' and 'Formatted size 3 TB' with a 'Format' button. A table lists the drives with columns for Capacity, Used, Available, and Used storage. The table has two rows: 'Network drive' and 'iSCSI Drive'. The 'iSCSI Drive' row is highlighted in blue and has a pencil icon on the right. The 'Used storage' column for the 'iSCSI Drive' shows '0%'.

	Capacity	Used	Available	Used storage
Network drive	1.2 TB	30.2 GB	1.2 TB	2%
iSCSI Drive	1.8 TB	0 B	1.8 TB	0%

## Advanced Parameters: iSCSI and CHAP

Click the configuration icon (pencil) and select **Advanced Settings** to modify parameters related to the iSCSI Drive. You can also configure CHAP (Challenge-Handshake Authentication Protocol) to limit access to the iSCSI volume.

**Important Info:** If you are using a Microsoft initiator, the CHAP password should be greater than or equal to 12 bytes and less than or equal to 16 bytes.

### Advanced Settings ×

CheckSum       Header Digest

**Chap:**

User name

Password

**Mutual CHAP:**

Initiator Name

Password

After modifying the above values, click **Apply**.

# ECO MANAGEMENT

## Eco management

Status light	<input checked="" type="checkbox"/>	
Turn off the hard drives	After 5 min <input type="button" value="v"/>	
Deep sleep enabled	<input checked="" type="checkbox"/>	
Power on/off schedule		
	Power on	Power off
Monday	08:00 <input type="button" value="pencil"/>	<input type="button" value="pencil"/>
Tuesday	<input type="button" value="pencil"/>	<input type="button" value="pencil"/>
Wednesday	<input type="button" value="pencil"/>	<input type="button" value="pencil"/>
Thursday	<input type="button" value="pencil"/>	<input type="button" value="pencil"/>
Friday	<input type="button" value="pencil"/>	22:00 <input type="button" value="pencil"/>
Saturday	<input type="button" value="pencil"/>	<input type="button" value="pencil"/>
Sunday	<input type="button" value="pencil"/>	<input type="button" value="pencil"/>

## UPS management

Connect a UPS to the device.

- **Status light:** Uncheck this box to turn off the front blue light. Note that this will not disable warning indicators or rear disk LEDs (see [LED Behavior and Button Functions](#) for details on LED status).
- **Turn off the hard drives (Eco mode):** Set the duration of inactivity after which the disks will revert to Eco mode. In Eco mode, the disks will spin down to reduce power consumption. The LaCie NAS will leave Eco mode automatically when a request is sent to the device.
- **Deep sleep enabled:** Check this box to allow your LaCie NAS to enter deep sleep mode. *Deep sleep* means that the drive will enter a very low energy consumption mode.
  - Manual: Once enabled, you will have the option to choose deep sleep mode in the **Shutdown Options** button on the Dashboard (upper right power icon). You can also apply a short press to the front blue LED button. The front LED will begin to blink, indicating that the device is preparing to enter deep sleep mode. To wake the drive from deep sleep mode, apply a short press to the front blue LED button or use the Wake on LAN function in LaCie Network Assistant (see [Wake on LAN \(WOL\)](#)).
  - Automatic: Set a schedule for the device to enter and exit deep sleep mode using **Power on/off schedule**.
- **Power on/off schedule:** Set the drive to activate/deactivate deep sleep mode to save energy. Deep sleep mode should be used when no one is accessing the NAS's data. For example, between 12:00 AM and 5:00 AM. Choose the configuration icon (pencil) under the **Power on** (wake from deep sleep) and **Power off** (enter deep sleep) columns to choose the times of day.

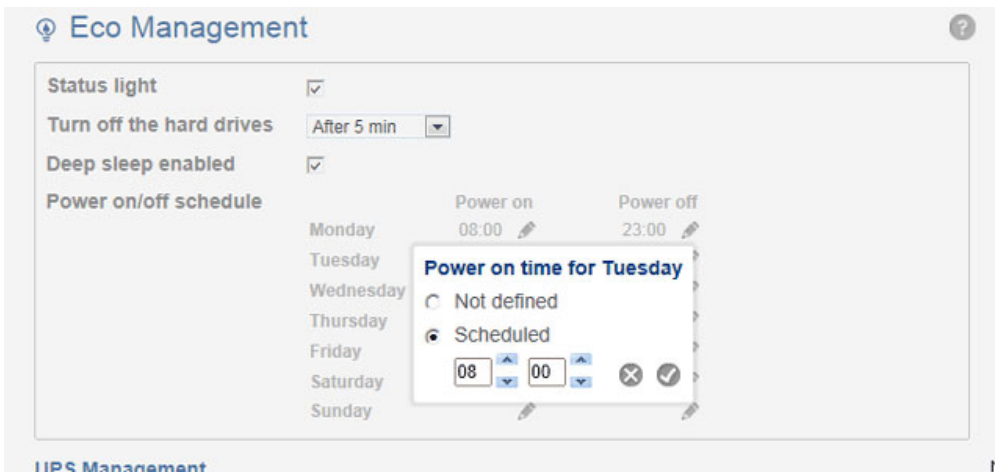

**Important info:** When deep sleep mode is activated, all processes, including downloads and backups, will be terminated. The shares are not accessible and the device cannot be managed via the Dashboard during deep sleep mode.

- **UPS Management:** Your LaCie NAS supports UPS (uninterrupted power supply) management. Connect a supported UPS device to a USB port on your LaCie NAS, then choose **Advanced** to set the battery threshold level (%). Upon reaching the threshold level, the LaCie NAS will automatically enter stand-by mode.

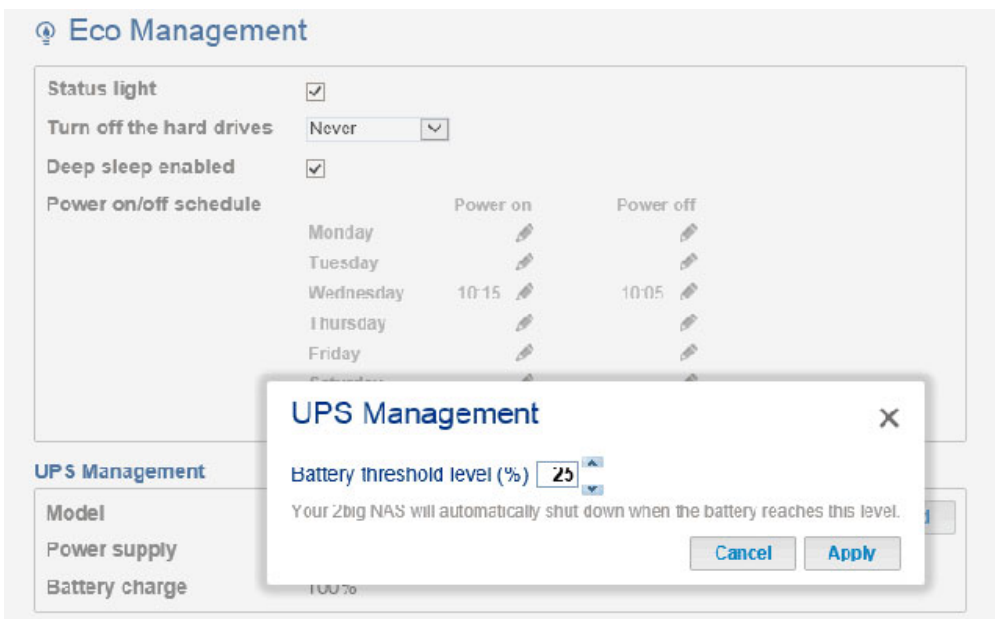

- UPS Management LED indications:
  - Green - power is being supplied through the power cable.
  - Gray - power is not being supplied through the power cable.
- For a list of supported UPS devices, choose this [link](#).

# MANAGE RAID - LACIE 2BIG NAS

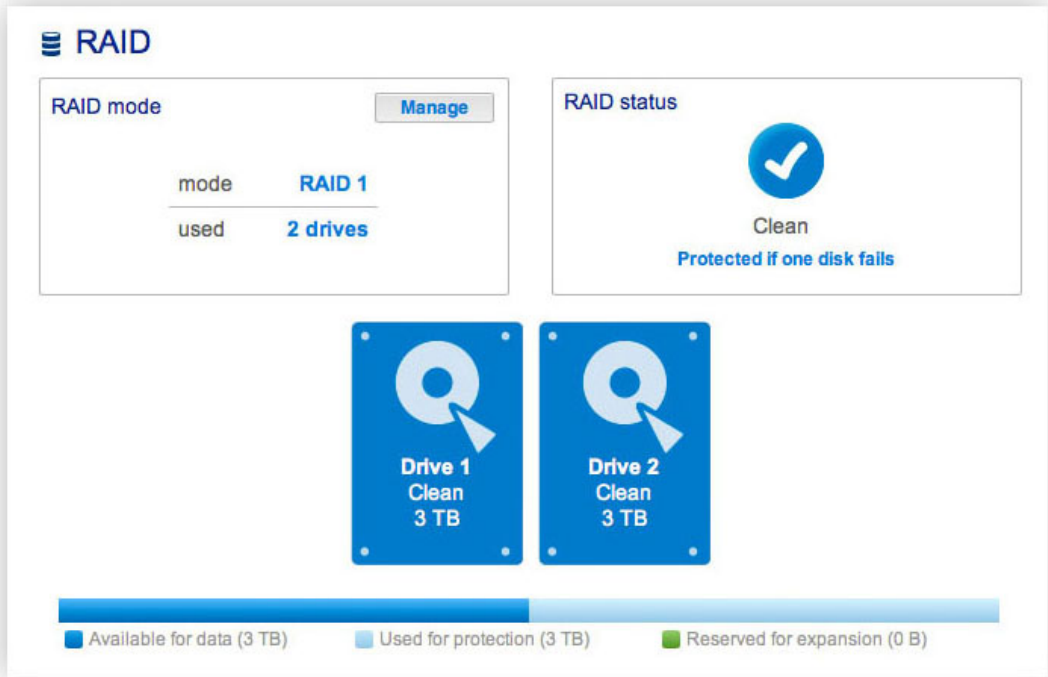

Your LaCie 2big NAS features a robust RAID management system that will allow you to choose and manage the RAID mode most optimized for your data.

## MODIFY RAID MODE

- **RAID mode:** This box shows you the current RAID scheme for your LaCie NAS, as well as the number of disks involved in the scheme.
- **RAID status:** This box lets you know whether the array is healthy, degraded, or synchronizing. A yellow warning icon will inform you if your array is unprotected in the case of a single disk failure. This may be due to a degraded protected RAID array or if you have chosen RAID 0.
- **Hard Drive map:** Click the illustration of the disk to see which slot in the LaCie NAS the disk occupies.

## RAID Setup Wizard

1. Click the **Manage** button to launch the RAID Setup Wizard. Choose which of the disks to include in the array. Click **Next**.

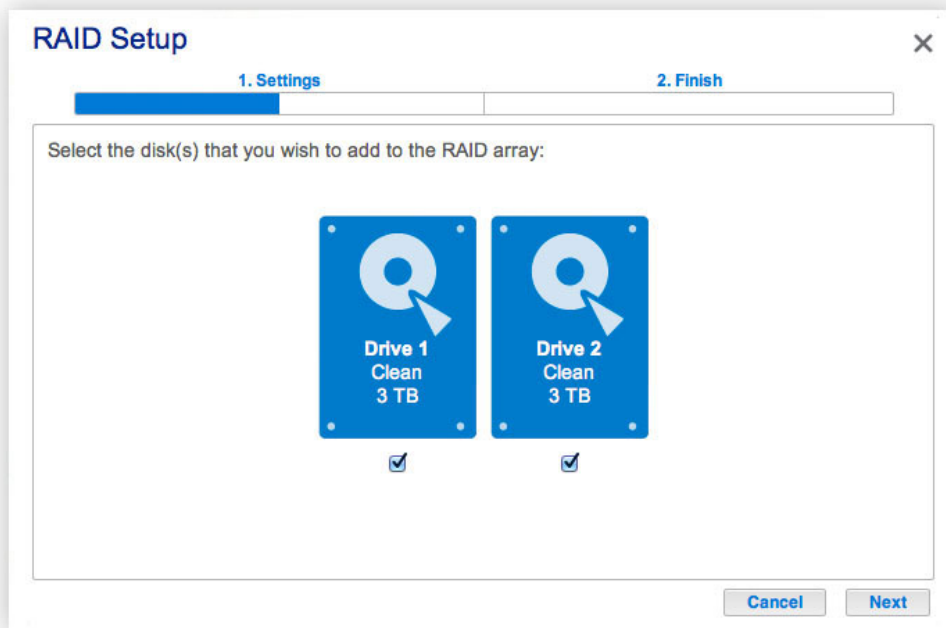

2. In the next screen, choose a RAID level. Clicking the RAID mode's button will give you an explanation of its strengths and weaknesses.

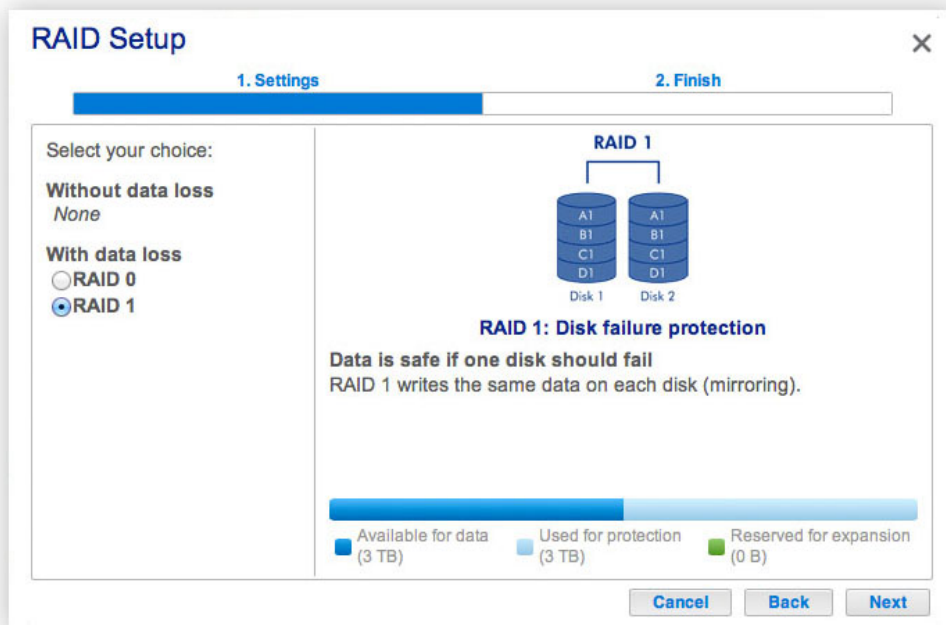

Note that converting to a new level of RAID (e.g. from RAID 1 to RAID 0 or RAID 0 to RAID 1) will erase files on the shares (but the Dashboard configuration will not be affected).

3. Click **Next**.
4. Review the information then click **Finish**. Confirm the RAID in the popup window.

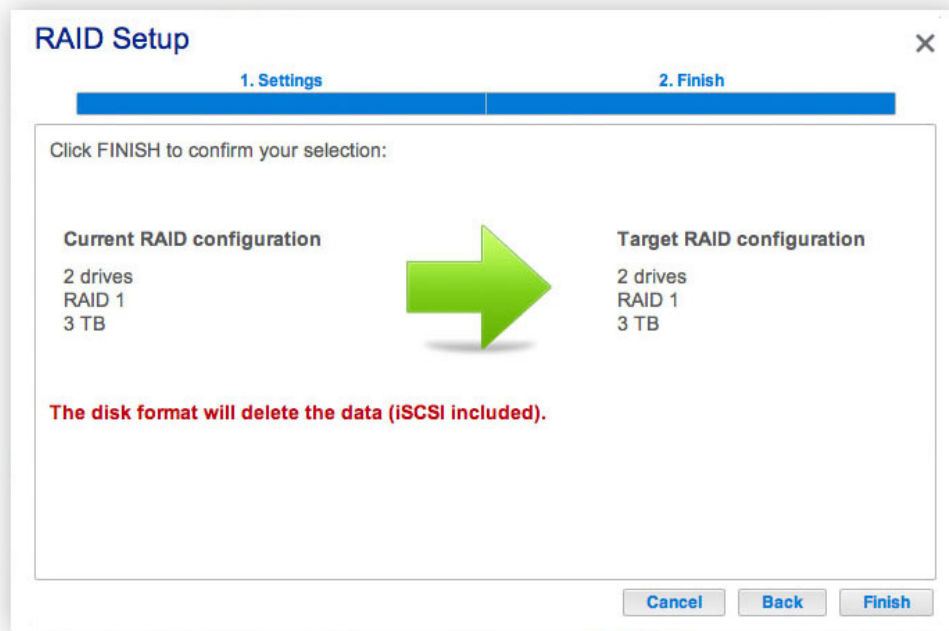

The Dashboard will become unavailable as the system configures the RAID.

## Rebuilding Times

Rebuilding a protected RAID array takes many hours, depending on the capacity of the disks and your LaCie NAS's available resources (concurrent tasks such as backups or torrent downloads will slow rebuilding). Changing to an unprotected RAID mode (ie RAID 0) takes less than five minutes. Note that data is accessible during rebuilding.

## ABOUT RAID MODES

Refer to the table below for an overview of the different RAID modes, and see the descriptions for details. Note that this information is also explained in the **RAID Setup Wizard** on the Dashboard (see above for details).

RAID Mode	Capacity	Protection	Factory Default
RAID 0	100%	★★★★★	-
RAID 1	50%	★★★★★	YES

**RAID 0:** RAID 0 gives users the total capacity of both hard disks as well as excellent performance. However, RAID 0 offers no protection if a hard disk fails.

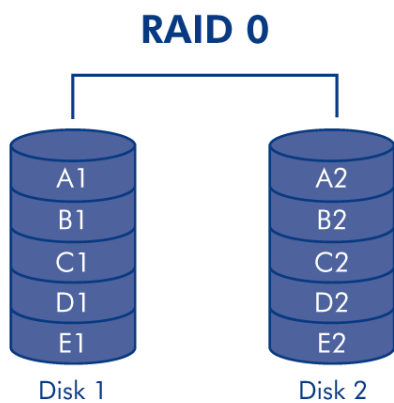



**Caution:** If one physical hard disk in a RAID 0 array fails, the data of all hard disks becomes inaccessible because parts of the data have been written to all hard disks.

**RAID 1:** RAID 1 provides data safety since all data is written to each hard disk at the same time. In the event of a single hard disk failure, data remains available on the other hard disk. Due to the time it takes to write the data twice, performance is slightly reduced. RAID 1 is a good choice when safety is more important than speed. However, RAID 1 also reduces the available hard disk space by 50% due to the need to write each bit of data on each hard drive.

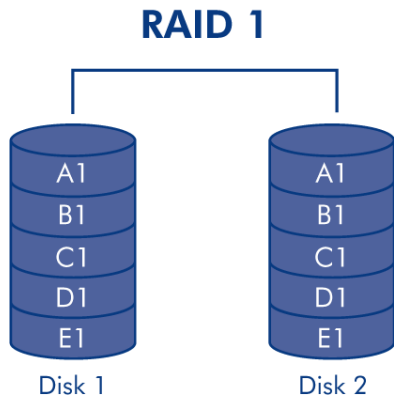

# REPLACING A HARD DISK

## Disk Removal

### **Unprotected RAID Arrays and Swapping/Expanding Hard Disks:**

- Removing a hard disk from a RAID 0 array while the device is powered on may cause you to lose data. To avoid problems, shut down the LaCie NAS before removing healthy disks. Return the hard drive to its proper bay before powering on the LaCie NAS.
- In cases where a hard drive has failed or you wish to expand storage capacity, data will be lost when replacing/swapping hard disks.

**Protected RAID Arrays and Swapping/Expanding Hard Disks:** If your array is protected (e.g. RAID 1), you can remove a hard disk while the product is turned on without damaging the array and losing data, a process also referred to as “hot-swapping”. In most instances, LaCie recommends hot-swapping when replacing or expanding hard disks in the LaCie NAS. For example, if you swap or insert unclean hard drives (with data) from another LaCie NAS (e.g. a LaCie 2big NAS to a LaCie 5big NAS Pro), you may experience problems when first booting your current LaCie NAS.

When replacing or expanding hard drives in a protected RAID array:

- Perform the operation while the LaCie NAS is powered on (hot-swapping).
- Use clean hard drives (without data).

**Caution:** After continuous use of the LaCie NAS, the hard drives may be hot. Use caution when removing.

1. The hard drive tray may be locked. To unlock it, use the included hard disk drawer key to turn the lock until the slot is vertical.

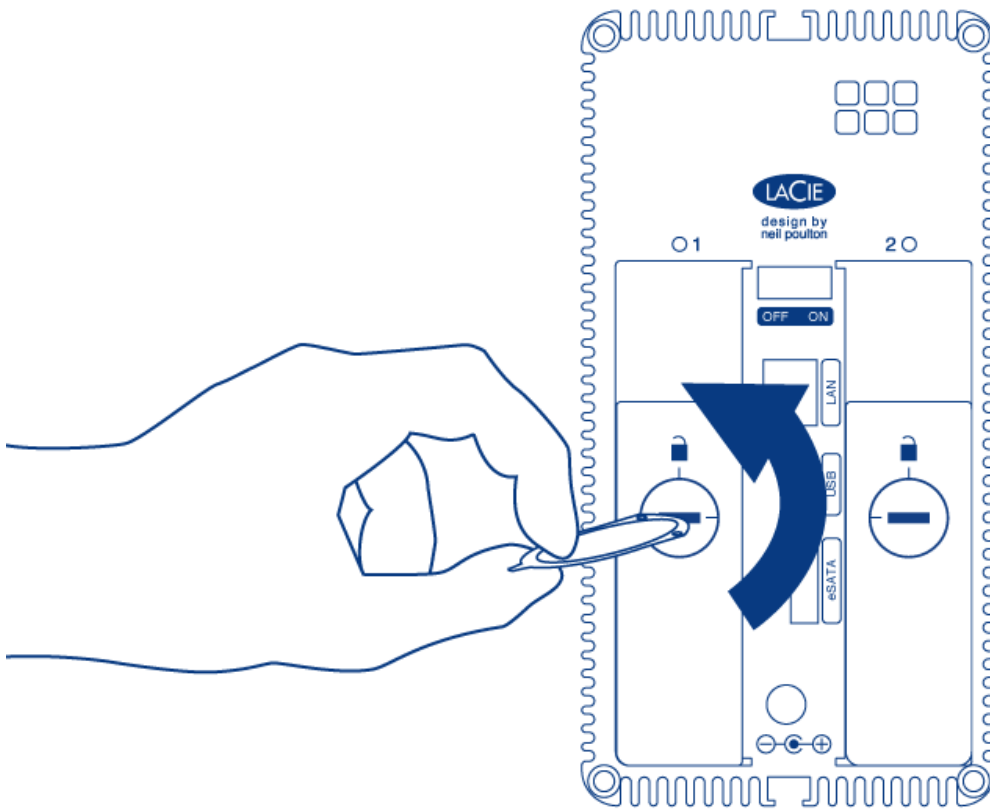

2. Draw out the hard drive tray by inserting your finger into the space behind the hard drive tray handle and pulling to disengage the hard drive.

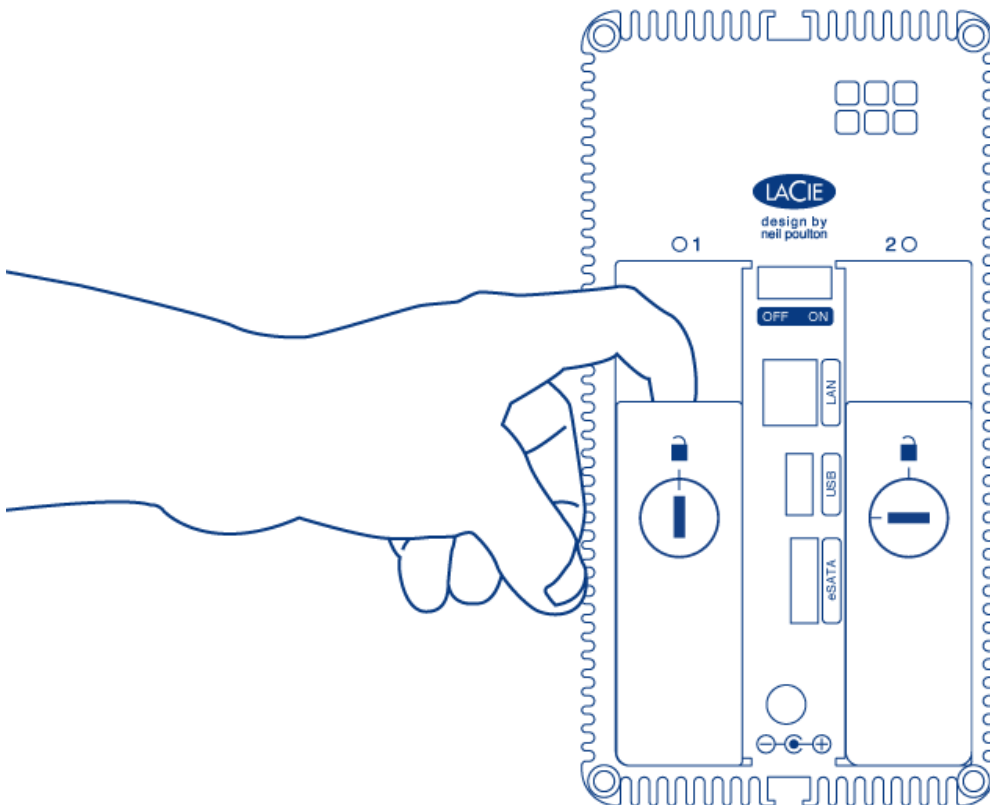

3. Grasp the hard drive tray handle and carefully extract the hard drive.

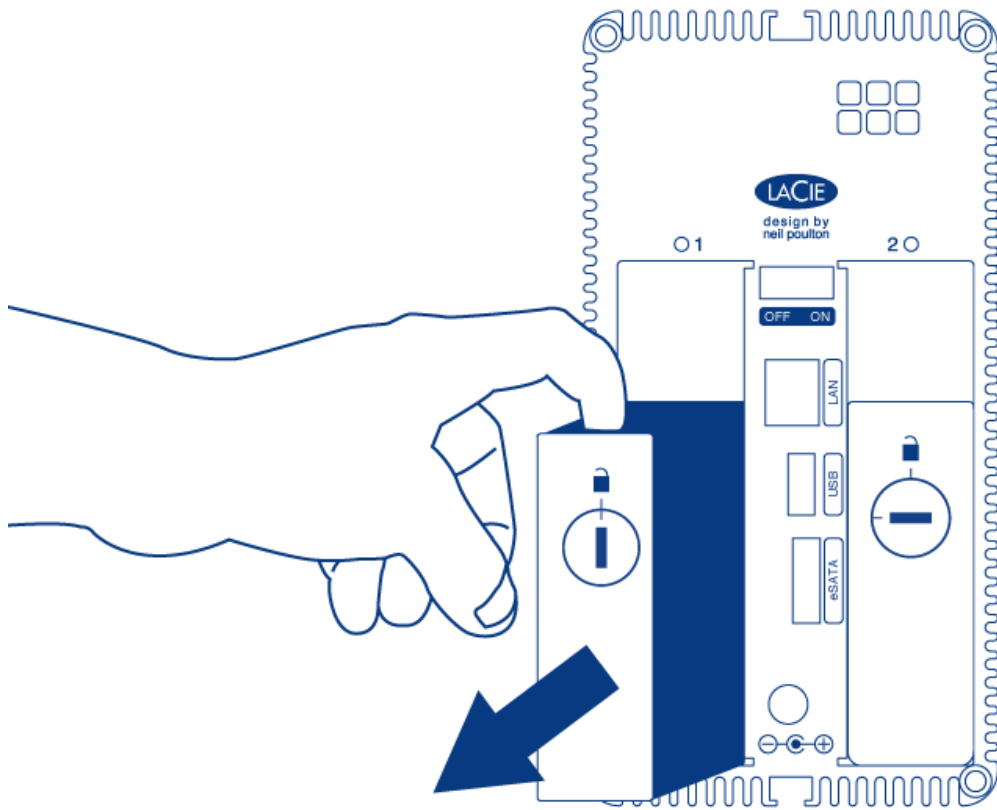

## Disk Insertion

**Important info:** If a hard disk that you have purchased from LaCie fails, please contact your LaCie reseller or LaCie Customer Support.

Replacing a hard drive involves two main steps, installing the new hard drive and claiming the new hard disk at **Dashboard > RAID** (see below). Note that the new hard disk must have equal or greater capacity than the hard disk it is replacing.

1. Carefully insert the tray into an empty hard drive bay. When the tray is most of the way in and you feel resistance, press the handle firmly until you feel the it snap into place and the handle is flush with the back of the LaCie NAS.
2. Use the disk drawer key to lock the hard drive.

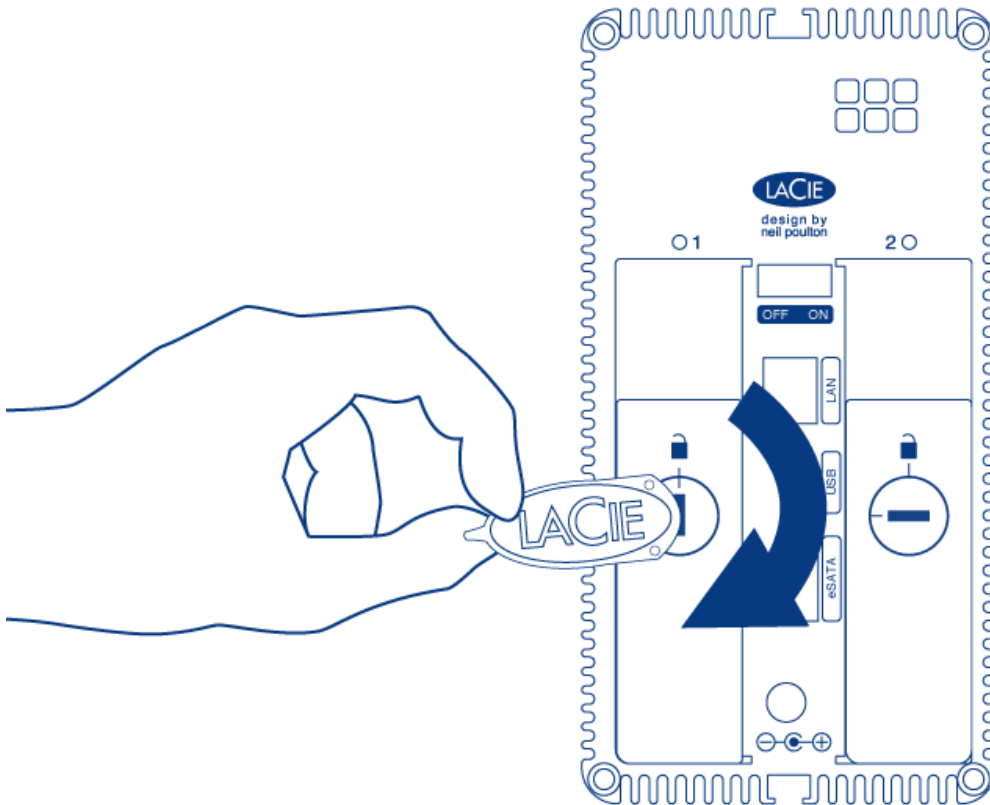

3. Navigate in the Dashboard to the **RAID Management** page. In the hard drive map, the new hard disk will be represented by a lighter grey color than the already-claimed disk and will be labelled **New** (see screenshot below, which shows a RAID 1 array).
4. If the LaCie 2big NAS is in RAID 1:
  1. Click the **Replace** button under the disk marked **New**.

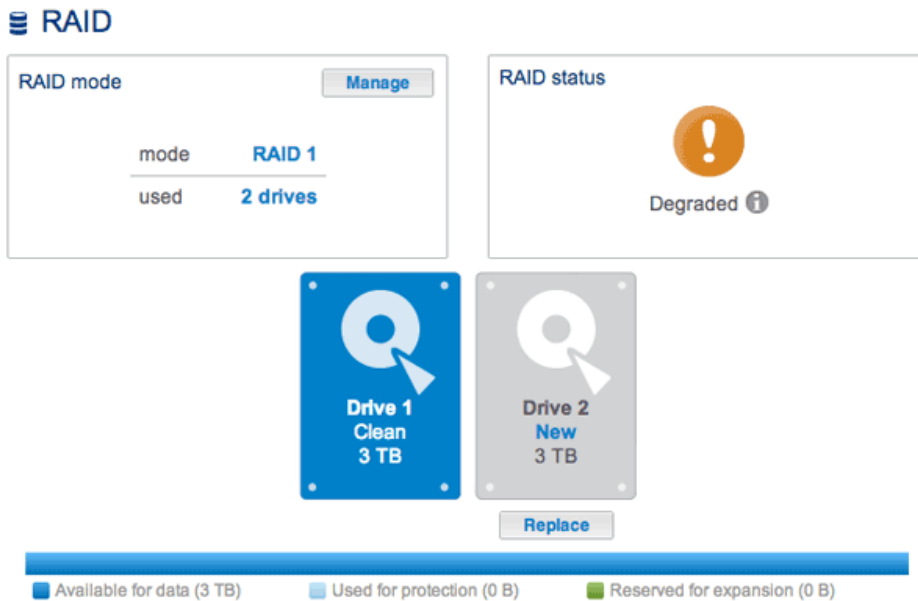

2. In the next screen, confirm the addition and complete the RAID Setup wizard.
3. You may use your LaCie 2big NAS as it rebuilds the data across both hard drives. Please note that performance may be affected during a rebuild.
5. If the LaCie 2big NAS is in RAID 0:
  1. Click the **Manage** button and complete the RAID Setup wizard.

The Dashboard will become unavailable while the RAID mode is changed.

## EXPAND DISK CAPACITY

RAID 1 configurations allow you to expand the capacity of your LaCie 2big NAS without losing data. Please note that RAID 1 configurations optimize storage with two hard drives of the same capacity.

**Example:** A RAID 1 array with data is comprised of two 1TB hard drives. The administrator wants to upgrade both hard drives to 3TB. To begin, the administrator removes the 1TB hard drive from Drive Tray 2. There is no need to power off the 2big NAS since RAID 1 supports hot-swapping. Per the instructions in [Disk Removal](#), the administrator removes the 1TB hard drive from the disk tray and screws in the new 3TB hard drive. Once the the disk tray with the new 3TB hard drive is reinserted into the 2big NAS chassis, the administrator synchronizes the RAID 1 array. The process is repeated for the second hard disk.

**Note on RAID 0 arrays:** If you are updating a RAID 0 array, please follow the steps in [Disk Removal](#) and [Disk Insertion](#).

1. LaCie recommends backing up all data before continuing with the next steps.
2. Go to **Dashboard > RAID**. Per the example above, the screenshot shows a RAID 1 array with two 1TB hard drives.

## LACIE 2big NAS

### RAID

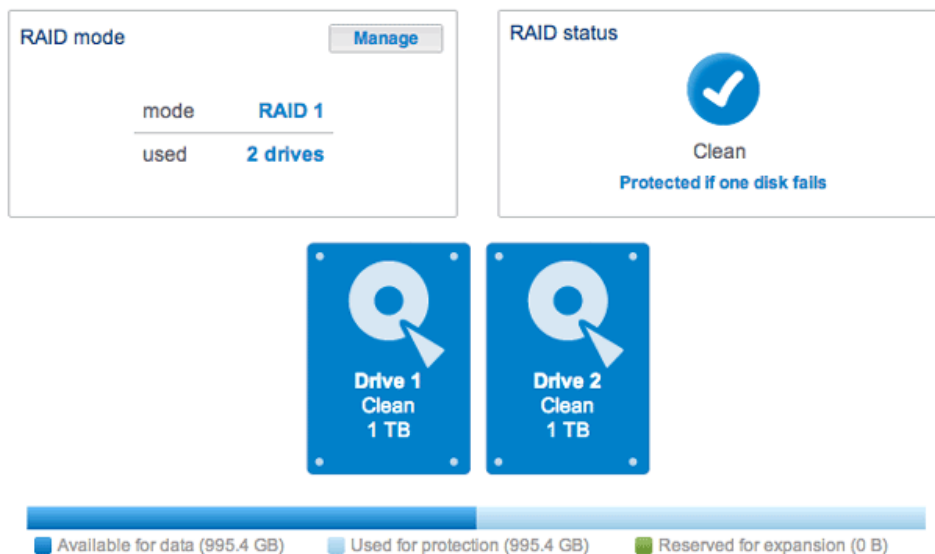

3. Remove Disk Tray 2 (the hard drive on the right when facing the rear of the LaCie 2big NAS). See [Disk Removal](#) for more information, if necessary. The Dashboard will show that the disk is missing.

## LACIE 2big NAS

### RAID

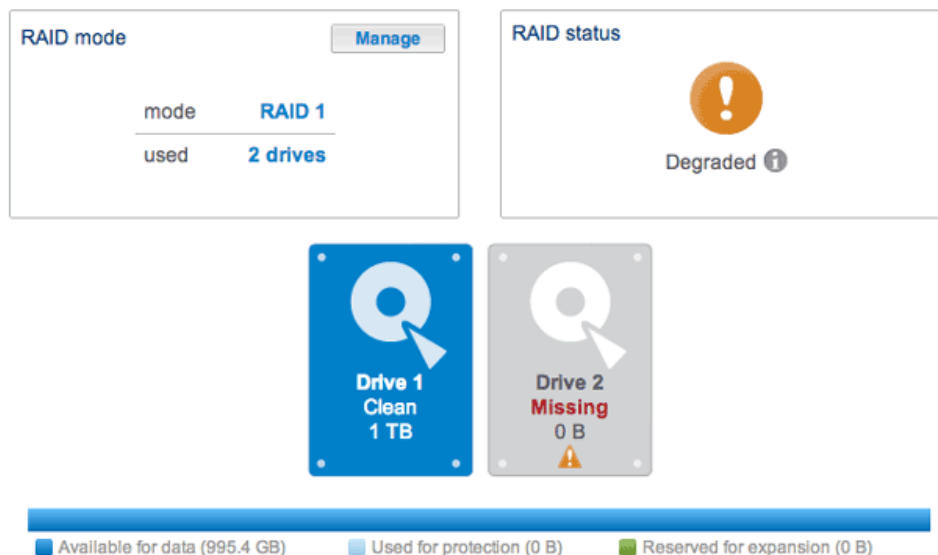

4. Remove the drive currently screwed into the Disk Tray and screw in the new hard drive. For instructions on how to fix a hard disk into the drive tray, please see [Connect to the Network: Diskless LaCie 2big NAS](#).
5. Carefully insert the tray with the new hard disk into the empty bay. When the tray is most of the way in and you feel resistance, press the handle firmly until you feel the it snap into place and the handle is flush with the back of the LaCie NAS. Use the disk drawer key to lock the hard drive.
6. The Dashboard will show the *New disk*. Click on **Replace** below the *New disk*. **DO NOT click Manage**.

Following the instructions in **Manage** will create a new RAID array and delete all media.

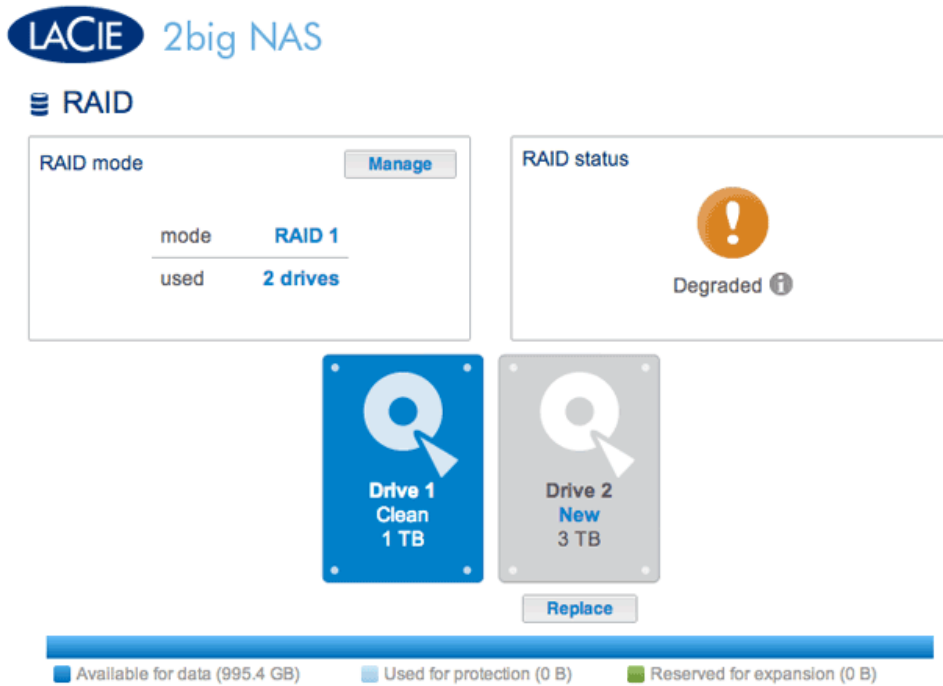

7. At the prompt, confirm the synchronization. While the Dashboard is not available during the initial phase of the synchronization, you may access data stored on your LaCie 2big NAS throughout the process.
8. Depending upon the capacity of your hard drives and the amount of data, the synchronization may take several hours.

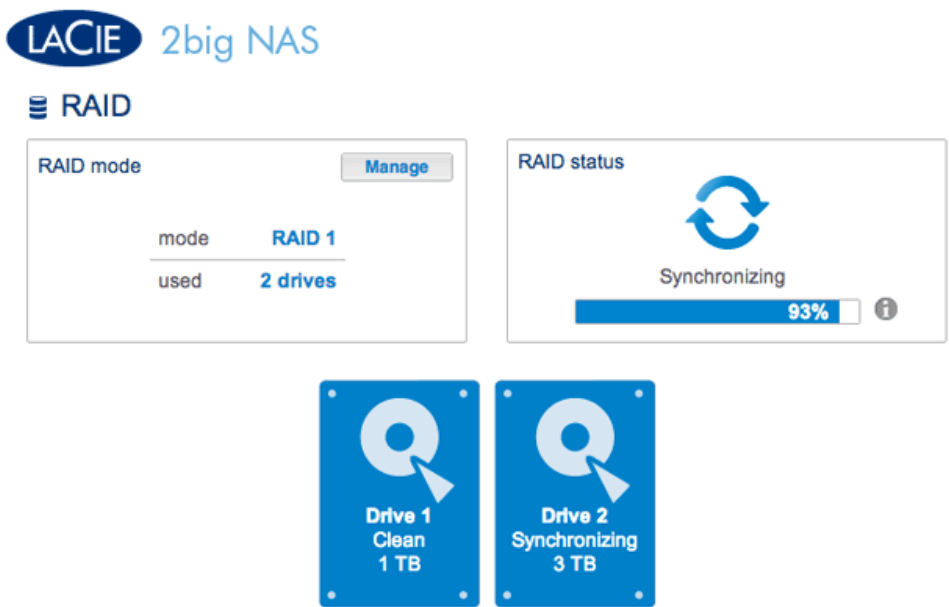

### ***Synchronizing the RAID***



RAID

RAID mode Manage

mode **RAID 1**

used **2 drives**

RAID status

**Clean**

Protected if one disk fails

Drive 1 Clean 1 TB

Drive 2 Clean 3 TB

Available for data (995.4 GB) | Used for protection (995.4 GB) | Reserved for expansion (2 TB)

**Synchronization**

**complete**

- Once the synchronization is complete, remove the hard drive in Drive Tray 1 and replace it with the second hard drive using the same steps as Disk Tray 2.

RAID

RAID mode Manage

mode **RAID 1**

used **2 drives**

RAID status

**Degraded**

Drive 1 Missing 0 B

Drive 2 Clean 3 TB

Available for data (995.4 GB) | Used for protection (0 B) | Reserved for expansion (2 TB)

- Click **Replace** under the *New disk* to begin the synchronization. **DO NOT click Manage**. Following the instructions in **Manage** will create a new RAID array and delete all media.

RAID

The screenshot shows the RAID management interface for a LACIE 2big NAS. The RAID mode is set to RAID 1, using 2 drives. The RAID status is 'Degraded', indicated by a red exclamation mark icon. Below the status, two drive icons are shown: Drive 1 is 'New' (3 TB) and Drive 2 is 'Clean' (3 TB). A 'Replace' button is located below the drive icons. At the bottom, a progress bar shows: Available for data (995.4 GB) in blue, Used for protection (0 B) in light blue, and Reserved for expansion (2 TB) in green.

11. At the prompt, confirm the synchronization. While the Dashboard is not available during the initial phase of the synchronization, you may access data stored on your LaCie 2big NAS throughout the process. Please note that the RAID 1 array is still configured for the capacity of the original hard disks. It is not possible to surpass the previous capacity at this time.
12. Once the synchronization is complete, click **Expand** in the *RAID status* section. **DO NOT click Manage.** Following the instructions in **Manage** will create a new RAID array and delete all media. The RAID 1 array will synchronize once more to extend the storage capacity to that of the new hard disks. In this example, from 1TB to 3TB. Data is available to users during the synchronization.

The screenshot shows the RAID management interface for a LACIE 2big NAS after expansion. The RAID mode remains RAID 1, using 2 drives. The RAID status is now 'Clean', indicated by a blue checkmark icon, with the text 'Protected if one disk fails' below it. An 'Expand' button is visible in the top right of the RAID status section. Below the status, two drive icons are shown: Drive 1 is 'Clean' (3 TB) and Drive 2 is 'Clean' (3 TB). At the bottom, a progress bar shows: Available for data (995.4 GB) in blue, Used for protection (995.4 GB) in light blue, and Reserved for expansion (4 TB) in green.

13. You have successfully expanded the RAID 1 array once synchronizing and resizing are complete.

# SUPPORT

## CONFIGURATION

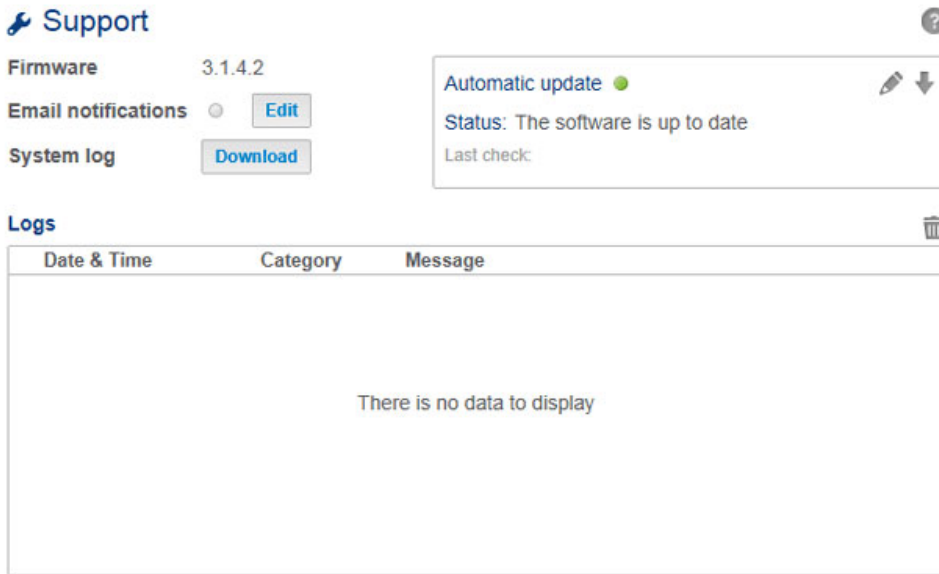

- **Firmware:** The LaCie NAS's operating system version will be listed here. This information is important when updating the NAS operating system or if you need to speak with LaCie technical support.
- **Email notifications:**
  - Choose the **Edit** button to configure email notifications. **Important: Make certain to enter the SMTP address for your email server. The LaCie NAS cannot send notifications without an email server.** You may use an in-house SMTP server or third-party providers such as gmail, hotmail, etc.
  - If verification is necessary, check the box next to **Authentication required** to enter the valid email address and password. (See **Email Notifications Triggers** below for events that will generate emails.)

### Email notifications ✕

Enable

SMTP server 192.168.25.16	Port 25
<input type="checkbox"/> Use SSL (optional)	
<input type="checkbox"/> SMTP authentication	
Name _____	
Password ••••••••	
<input checked="" type="checkbox"/> Send a verification email	
Email test dash@lacie.com	

### Email server prompt

Host : LaCie-5big-Pro  
Model : 5big NAS Pro  
System Time : Mon, 13 May 2013 15:37:59

This is a test email to check the SMTP configuration.  
Current server is 192.168.25.16.25.

[ This message is automatically generated by the LaCie email notification service. ]  
[www.lacie.com](http://www.lacie.com)

### Test email from the NAS

- **System log:** Choose the **Download** button to save the system log to your computer.

## Email notification triggers

The following events will trigger an email notification if an email address has been provided on the User page:

Event identifier	Description	Recipient
Capacity	The total available capacity is less than 10%	Administrator
Download	A download job has completed or a download job error has occurred	Administrator
Backup	A backup job has: started, ended, been cancelled, or failed	Administrator
Test email	Email sent as a test on the Support page	Administrator
RAID	Creation of a RAID volume; unprotected volume or broken RAID	Administrator
Fan	The fan has stopped (5big NAS Pro only)	Administrator
Temperature	The product has remained at maximum temperature for at least one minute	Administrator
Password recovery	A user has recovered his/her password	Administrator or user, depending on who made the request

# AUTOMATIC UPDATE

LaCie may improve your LaCie NAS's software or add new features over time. Your LaCie NAS automatically checks for new firmware and, if an update is found, prompts you to install it at login.

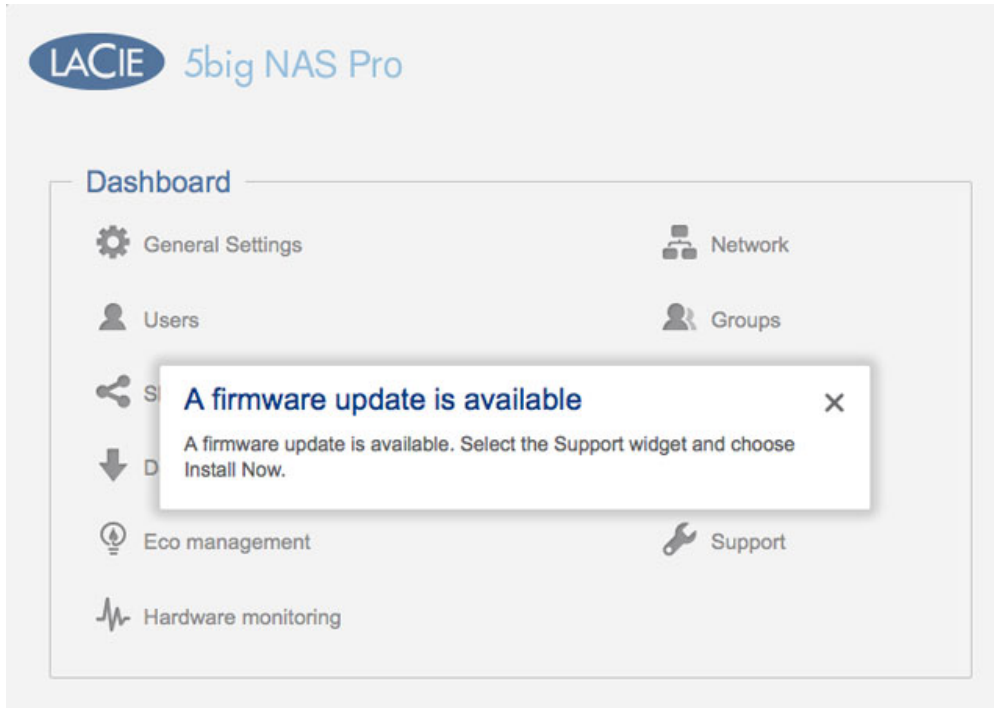

Review the additional options below:

Update Using the Dashboard

1. Launch the Dashboard and navigate to the **Support** page.
  1. Automatic: Select the **Automatic update**, configuration icon (pencil). Choose the Frequency and Time for the NAS to check the update server.

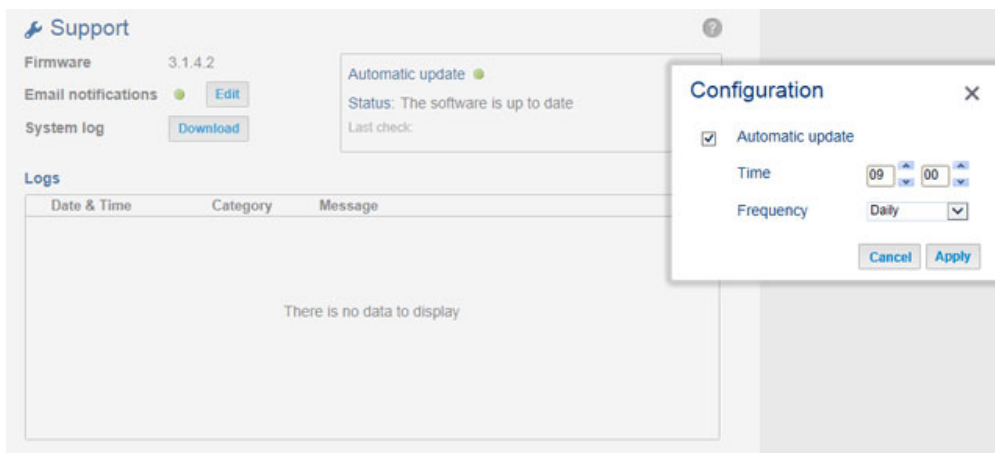

2. Manual: Check for an update manually by choosing the grey, downward arrow.

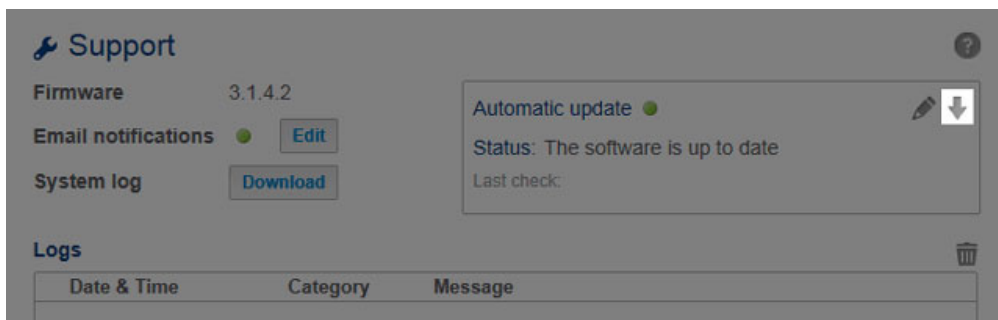

If a link appears, choose it to begin the download and follow the update instructions. During the process, the LaCie NAS will reboot.

Update Using LaCie Network Assistant (LaCie 2big NAS only)

Follow the steps below if you wish to download the LaCie NAS OS update from the product support website. This update procedure will not erase your configuration or files saved to the drive.

**Important info:** Before proceeding, make sure to:

- Connect your PC/Mac to the network using an Ethernet cable (turn off wireless connections).
- Make sure users on your network have stopped data transfers to the NAS.
- Turn off other NAS on the network except the one you wish to update.
- Disconnect all connections to shares on the NAS you want to update.

1. Make sure you are using the [latest version](#) of LaCie Network Assistant. If you download a newer version, uninstall previous versions before continuing with the update.
2. Download the software update for your NAS [here](#).
3. Run LaCie Network Assistant.
4. Go to **Preferences** and make sure **IPConf Support** is deactivated.

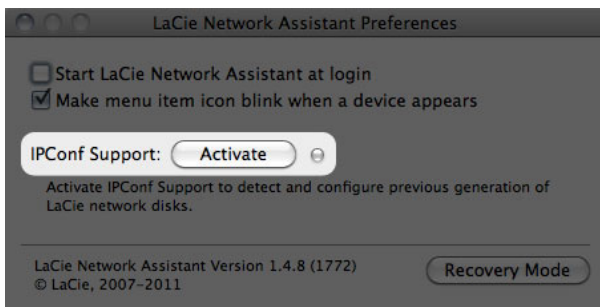

5. Select your product from the list on the left and then choose the **Configuration** tab.
6. Choose the **Update your NAS...** button, then enter your administrator username and password.
7. Enter your LaCie NAS administrator login and password.

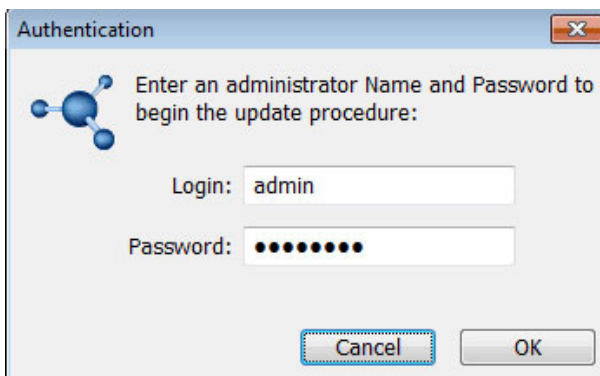

8. Browse to and load the update package (.capsule file) you downloaded from the LaCie website.
9. Choose **Continue...** to begin the update. Mac users may be prompted to enter the computer's administrator password.
10. Once complete, verify the update:
  - Launch LaCie Network Assistant then select the **Configuration** tab. Choose your NAS on the left of the window. The system version will be listed on the lower left.



**Important info:** During the update process, the front LED will blink red and blue.

## LOGS

The **Logs** section will list important events, such as RAID changes, downloads, warnings, and much more. To purge the listings from this list, choose the trash icon.

# MANAGE RAID - LACIE 5BIG NAS PRO

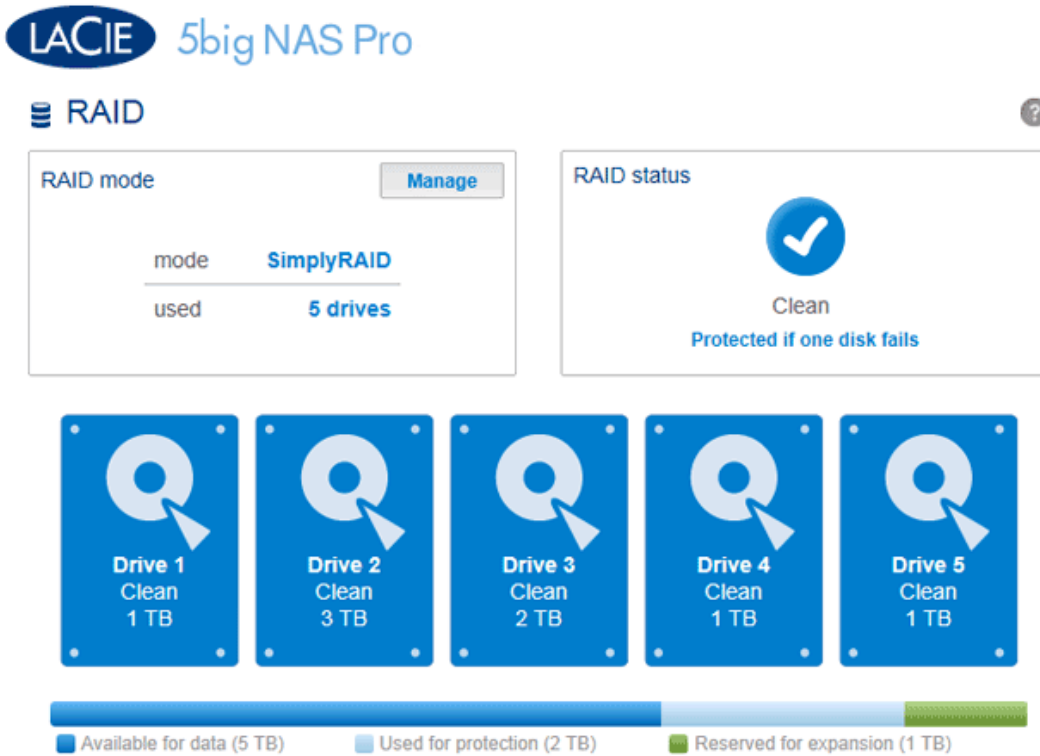

Your LaCie 5big NAS Pro optimizes disk performance and capacity using LaCie SimplyRAID. No matter the capacity of your disk(s), LaCie SimplyRAID will prepare the LaCie 5big NAS Pro storage for immediate use as well as future expansion. LaCie SimplyRAID accommodates your storage needs, allowing you to:

- Install disks of varying capacities (1TB, 2TB, and 3TB)
- Replace smaller capacity disks with larger capacity disks
- Upgrade storage capacity without deleting or moving data
- Protect data without compromising performance

While LaCie recommends the benefits of LaCie SimplyRAID, the Dashboard RAID page also gives you the option to manually configure RAID.

## REVIEW YOUR RAID SETTINGS

### RAID mode

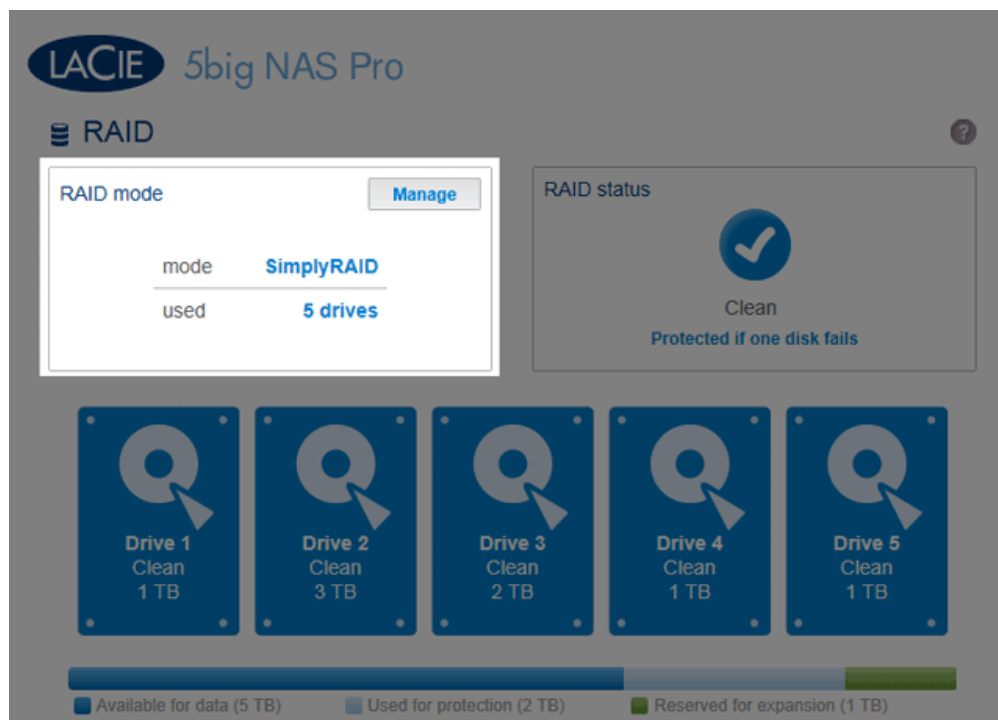

This box shows you the current RAID scheme for your LaCie NAS, as well as the number of disks involved in the scheme.

## RAID Status

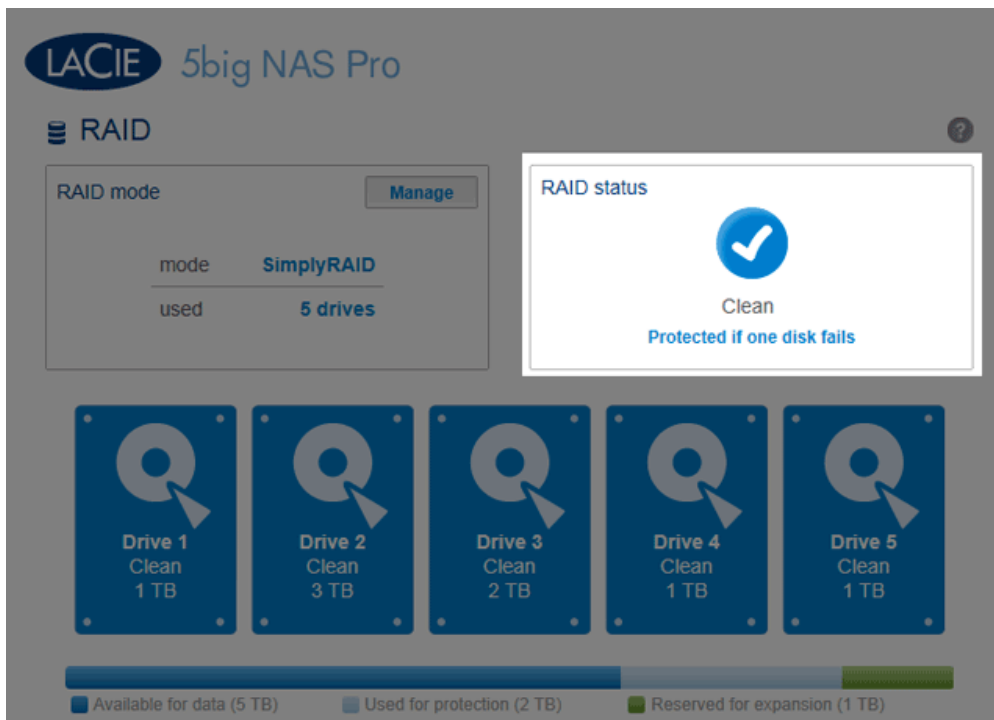

This box lets you know whether the array is healthy, degraded, or synchronizing.

- RAID 0 (no data protection).

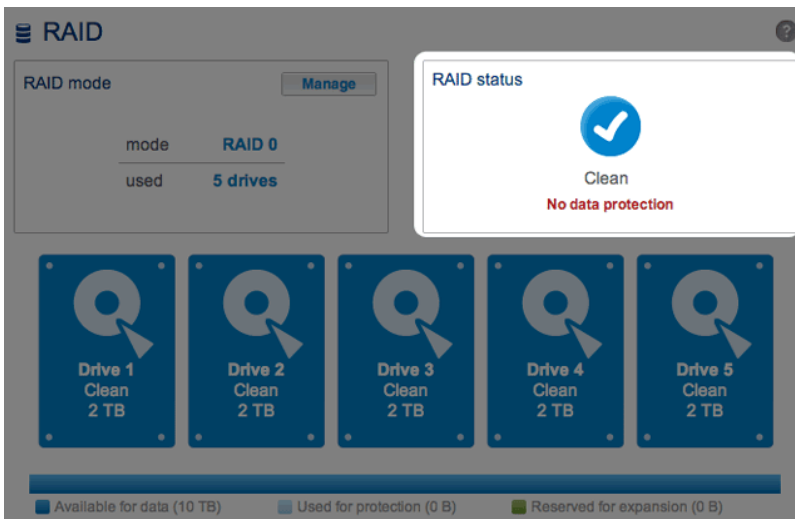

- RAID degraded due to a missing disk.

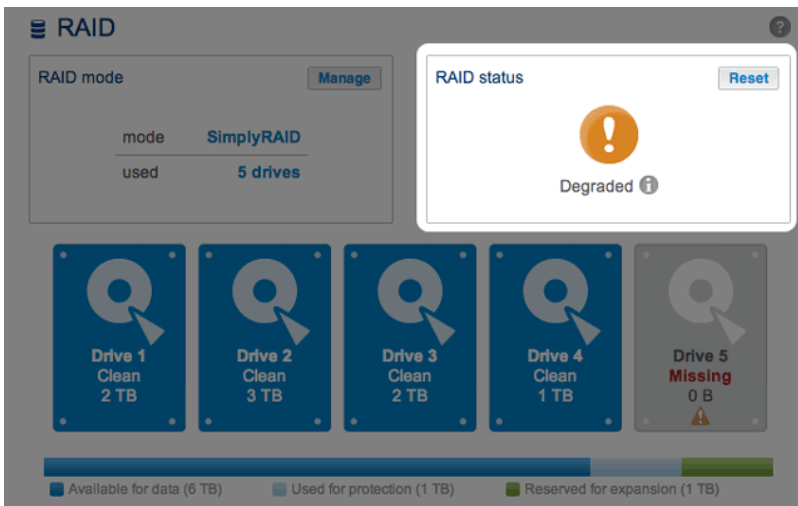

- RAID failure due to missing or bad disks.

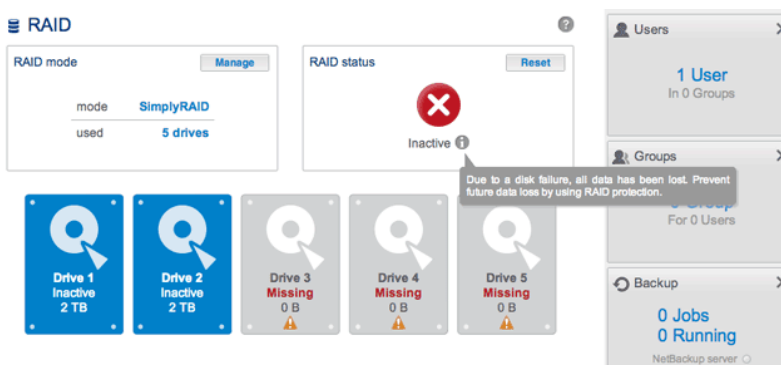

- RAID synchronizing following a disk replacement.

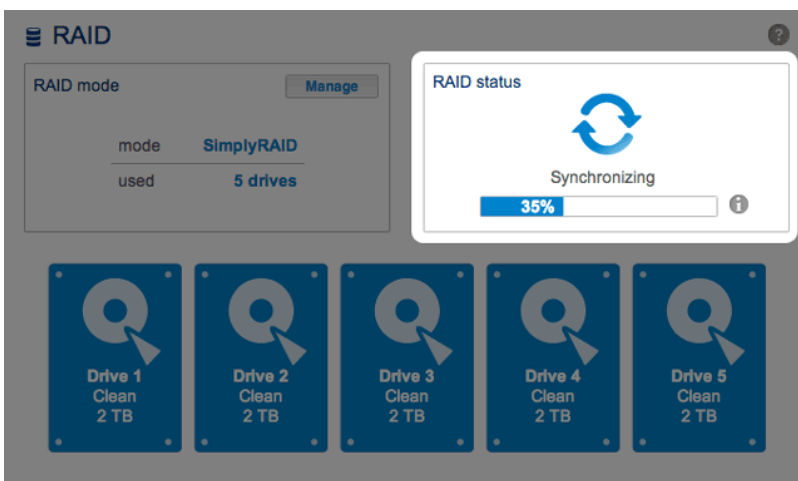

See [RAID Status: Expand, Replace, and Reset](#) for instructions on expanding your array and replacing disks.

## Hard Drive Map

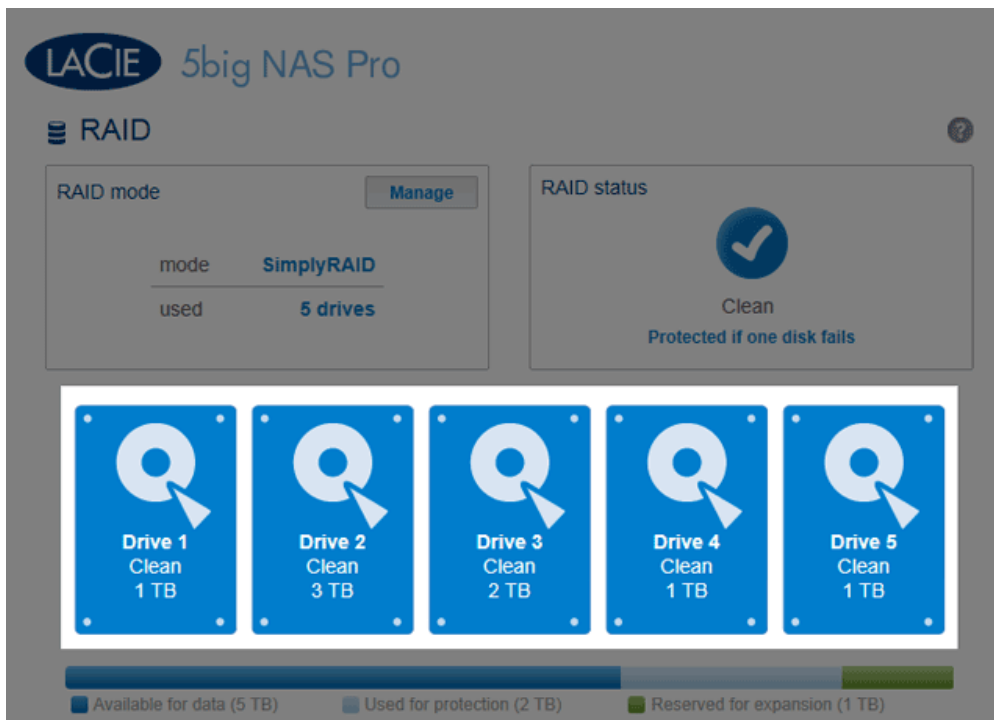

Click the illustration of the disk to see which slot in the LaCie NAS the disk occupies.

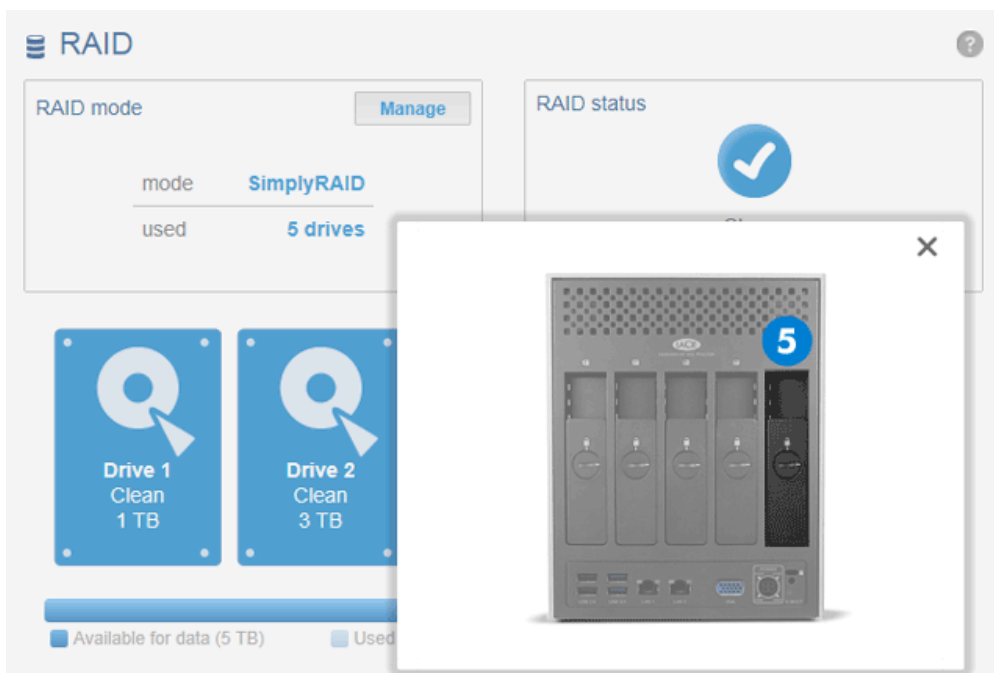

**Click on the Hard Drive to see its physical location**

## Storage Distribution

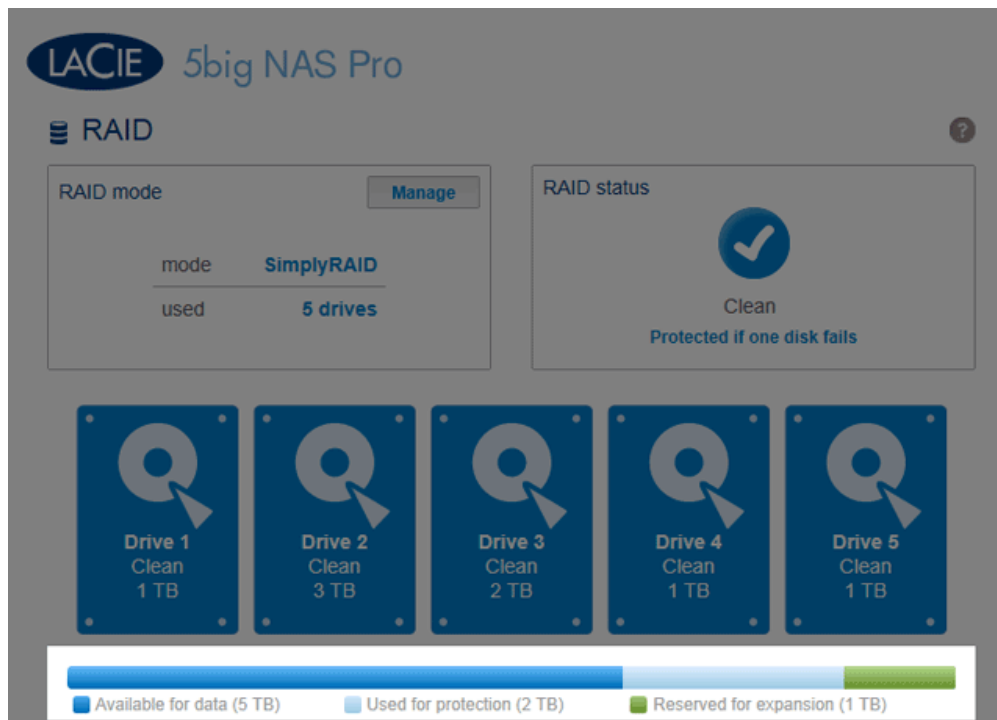

The multicolor bar below the disks provides a fast reference on how LaCie SimplyRAID distributes the LaCie 5big NAS Pro storage.

- Dark blue: Storage capacity for your data.
- Light blue: Protection in case one or two disks fail. The light blue indicator will vary in size depending upon single or double disk protection.
- Green: Disk capacity that spans beyond the level of RAID assigned by LaCie SimplyRAID. This space is reserved for expansion should you add new or larger capacity disks.

## Storage capacity and distribution

Factors that determine available data capacity include:

- The amount of disks in the enclosure
- The storage capacity of each disk (see note below on mixed capacities)
- RAID Mode
- Single disk or double disk security

Examples:

- **Manual RAID 0 configuration with five disks.** The only color is dark blue since RAID 0 has no protection and all the disks are of equal capacity (2TB).

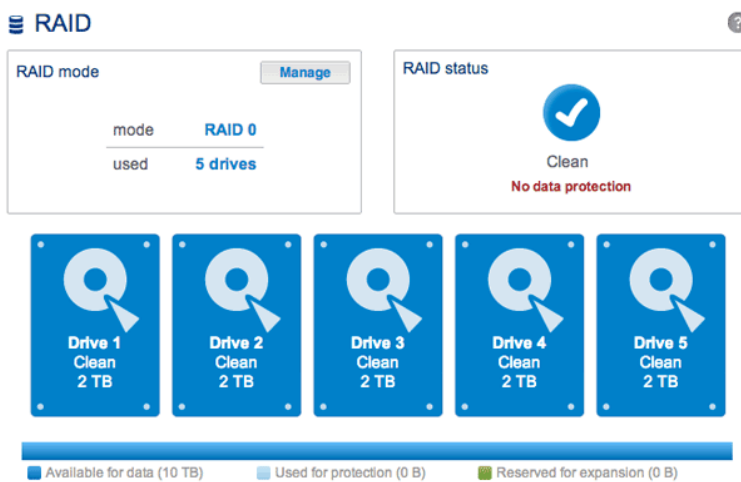

- **LaCie SimplyRAID configuration with five disks.** All colors are represented since the RAID array uses single disk security and the disks are of mixed capacities.

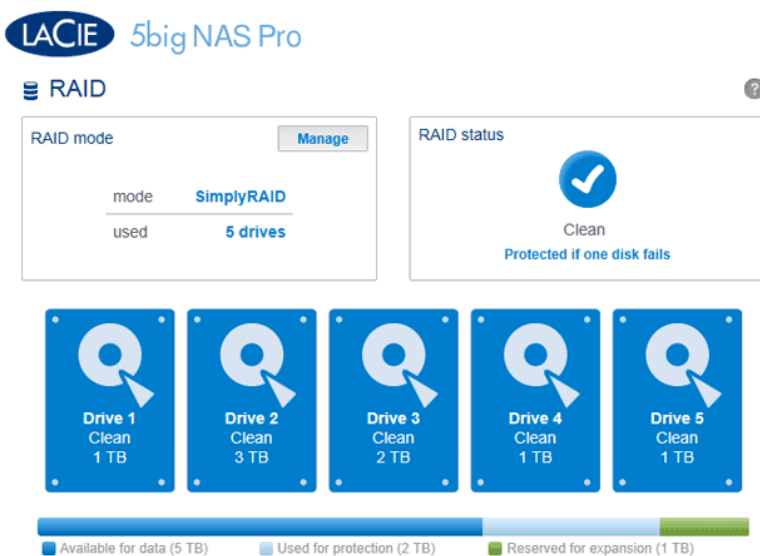

- **LaCie SimplyRAID configuration with three disks.** All colors are represented since the RAID array uses single disk security and the disks are of mixed capacities.



# RAID



**RAID mode** Manage

mode	SimplyRAID
used	3 drives

**RAID status**



Clean

Protected if one disk fails

 <p>Drive 1 Clean 2 TB</p>	 <p>Drive 2 Clean 1 TB</p>	 <p>Drive 3 Clean 1 TB</p>	 <p>Drive 4 Empty 0 B</p>	 <p>Drive 5 Empty 0 B</p>
---	---	---	--	--



## ABOUT RAID MODES

Refer to the table below for an overview of the different RAID modes, and see the descriptions for details. Note that this information is summarized in the **RAID Setup Wizard** on the Dashboard.

RAID Mode	Minimum Hard Drives	Data Capacity	Protection	Performance	Factory Default
SimplyRAID	2	Optimized	★★★★★	★★★★★	Yes
RAID 0	2	100%	★★★★★	★★★★★	-
RAID 1	2	50%	★★★★★	★★★★★	-
RAID 5	3	60% - 75% (estimate varies by disk configuration)	★★★★★	★★★★★	-
RAID 6	4	60% (estimate varies by disk configuration)	★★★★★	★★★★★	-

**Note on RAID 0 and 4TB hard drives:** RAID 0 configurations with five hard drives cannot surpass 16TB. LaCie recommends against using five 4TB hard drives in a RAID 0 configuration.

**Note on RAID 1:** RAID 1 will not be available in four- and five-disk configurations.

### LaCie SimplyRAID

RAID configurations will use equal disk capacities among the pool of hard drives to protect data. Rather than lose hard disk capacity overhead in mixed disk environments, SimplyRAID will preserve the extra space to use when new disks are added to the enclosure. Unlike standard RAID models, you can easily expand the array without losing data. For example, two 1TB disks will create a RAID 1 array without any disk capacity overhead. However, one 1TB disk paired with one 2TB disk can only create 1TB of protection since data cannot surpass the storage capacity of the smallest disk. SimplyRAID will calculate the overhead and prepare it for future disk expansion.

### RAID 0

RAID 0 (also called Spanning mode in some LaCie devices), is the fastest RAID mode. In a RAID 0 array, the available capacities of each disk are added together so that one logical volume mounts on the computer. It offers the best performance but no protection in the case that a disk fails.

**Caution:** In a RAID 0 array, if one physical disk in the array fails, the data of all disks becomes inaccessible because parts of the data have been written to all disks.

## RAID 0

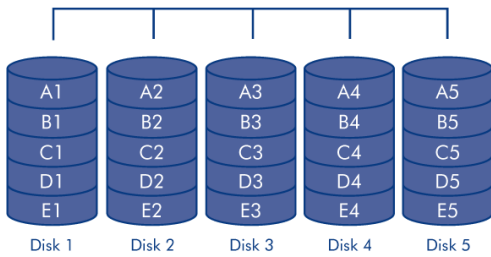

## RAID 1

RAID 1 is a secure RAID mode that is available if the LaCie 5big NAS Pro has only two disks installed. RAID 1 provides data safety since all data is written to each disk at the same time. In the event of a single disk failure, data remains available on the other disk. Due to the time it takes to write the data twice, performance is slightly reduced. RAID 1 is a good choice when safety is more important than speed. However, RAID 1 also reduces the available disk space by 50% due to the need to write each bit of data on each hard drive.

## RAID 1

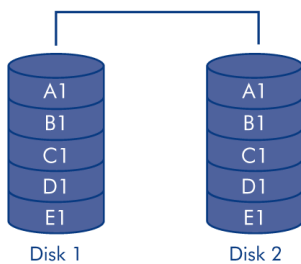

## RAID 5

In RAID 5, data is striped across all disks (minimum of three) and a parity block for each data block (P in the illustration below) is written on the same stripe. If one physical disk fails, the data from the failed disk can be rebuilt onto a replacement disk. No data is lost in the case of a single disk failure, but if a second disk fails before data can be rebuilt to a replacement hard drive, all data in the array will be lost.

## RAID 5

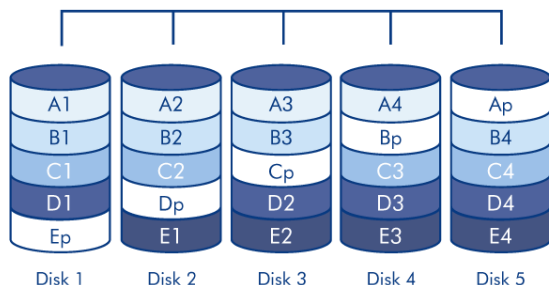

## RAID 6

In RAID 6, data is striped across all disks (minimum of four) and two parity blocks for each data block (p and q in the illustration below) are written on the same stripe. If one physical disk fails, the data from the failed disk can be rebuilt onto a replacement disk. This RAID mode can support up to two disk failures with no data loss. RAID 6 provides for faster rebuilding of data from a failed disk.

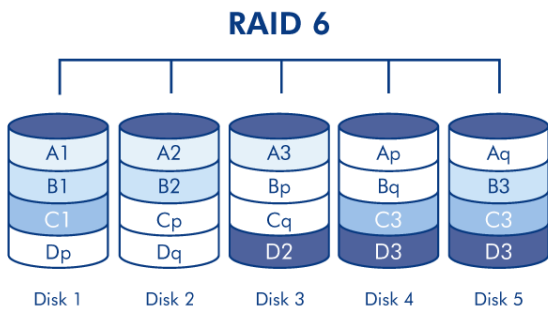

RAID 1+Spare(s), RAID 5+Spare(s), and RAID 6+Spare

RAID Mode	Maximum Spare(s)
RAID 1	3
RAID 5	2
RAID 6	1

In a RAID 1 configuration, the same data is written across all hard disks in the array. With RAID 5 and RAID 6, data is available from the parity blocks. In both cases, a RAID+Spare array gives you a “hot-spare” that is ready to rebuild the system should a disk fail. If a hard disk in the RAID array fails, the data is immediately copied or rebuilt onto the hot spare disk. The clear advantage for a RAID array with a spare is that you do not have to wait for a replacement disk.

When the failed disk is replaced, the replacement becomes the new hot spare. No data is lost in the case of a single disk failure, but if a second disk fails before the system can rebuild data to the hot spare, all data in the array will be lost. It is possible to create an array with more than one spare.

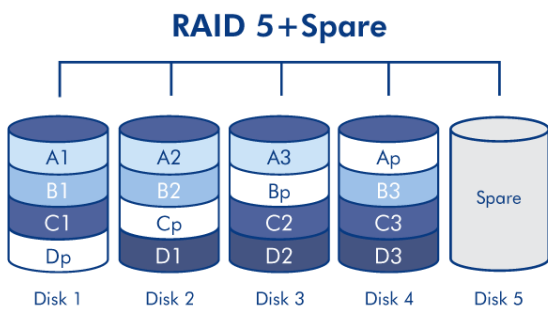

See [RAID Setup Wizard](#) for instructions on creating a spare hard drive (Only available with **Standard** mode. LaCie SimplyRAID optimizes disk space for you.)

## RAID SETUP WIZARD

Follow the directions to run the RAID Setup Wizard. You may select:

- **LaCie SimplyRAID:** LaCie's smart RAID configuration agent.
- **Manual RAID:** Configure your array using standard RAID models based upon the amount of disks in your

enclosure.

### LaCie SimplyRAID

1. Click the **Manage** button to launch the RAID Setup Wizard.
2. Select **SimplyRAID** then click **Next**.

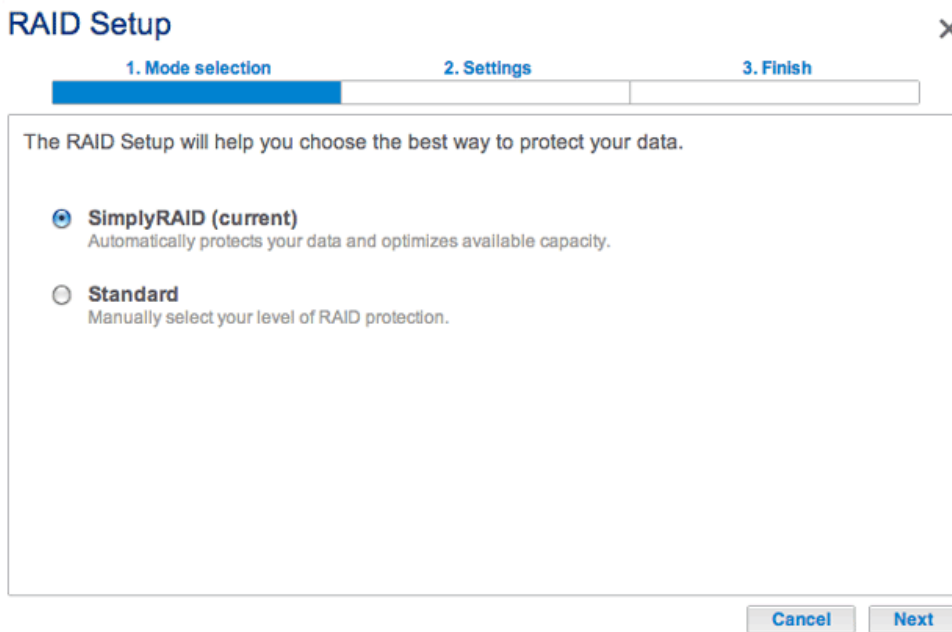

3. Choose the level of security then click **Next**. Please note that all data on the disks will be deleted to create the initial RAID configuration. Future updates to storage capacity will not delete data.
  - Single security will protect data against the loss of a single hard disk (minimum of two hard disks required).

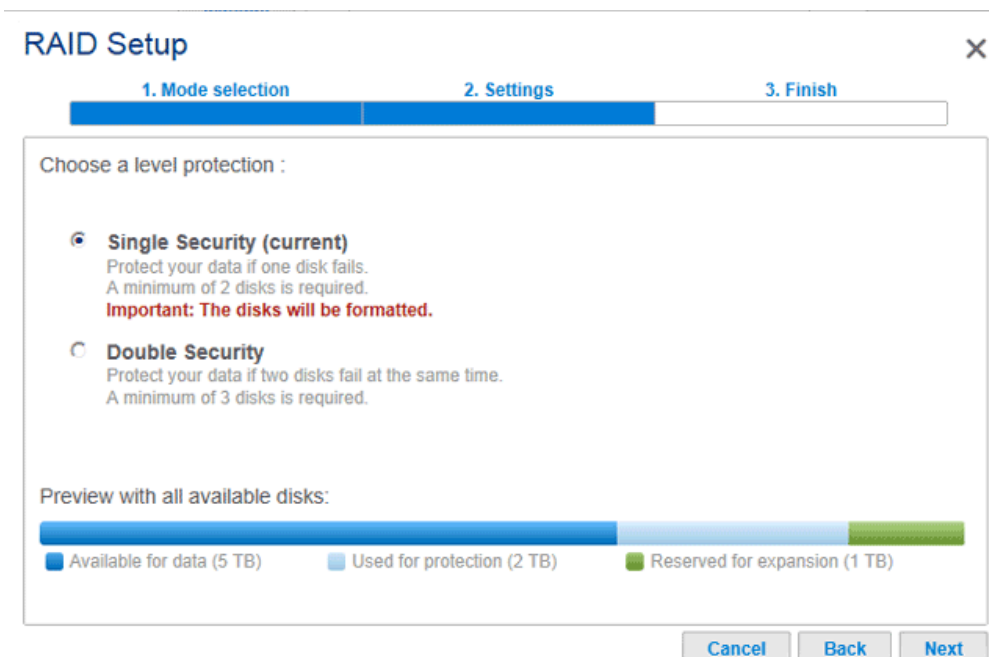

- Double security will protect data against the loss of two hard disks (minimum of three hard disks required).

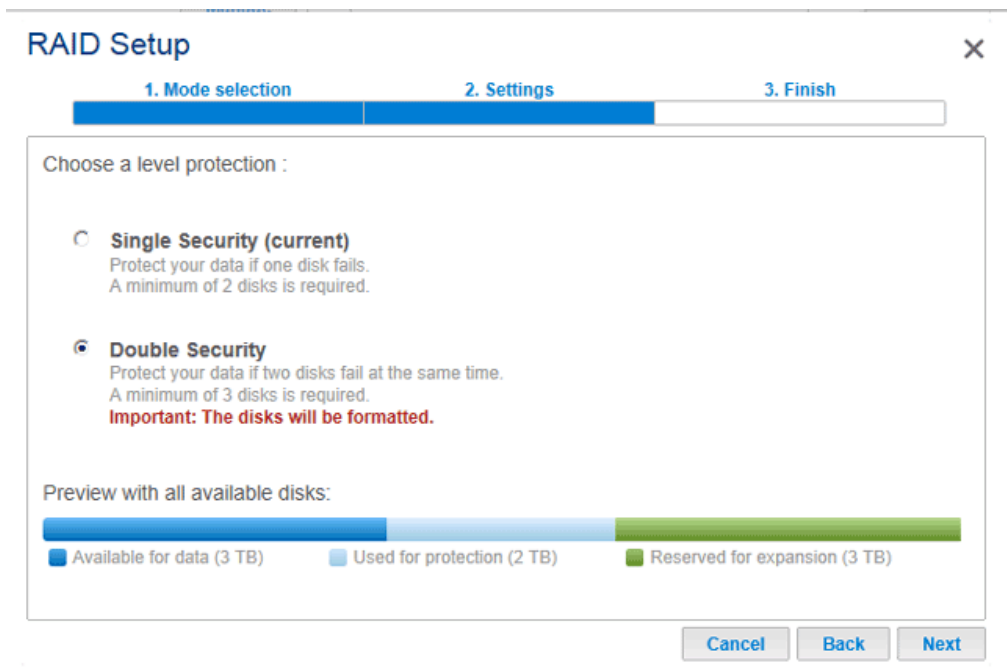

4. Click **Finish** to configure the RAID, then **Yes** at the prompt.

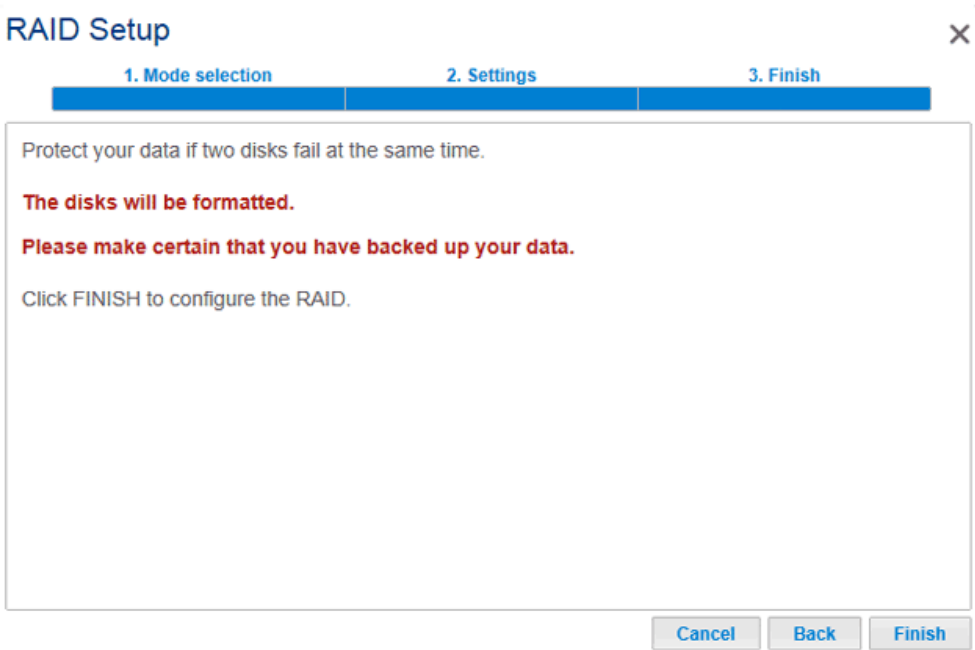

## Manual RAID

Your options to select the level of RAID are predicated upon the number of disks in your array. For example, a three-disk configuration allows you to select from RAID 0, RAID 1, or RAID 5. A four- or five-disk configuration offers RAID 0, RAID 5, or RAID 6.

**Adding a spare:** If you intend to create an array with a spare drive, you must leave at least one hard drive bay free. For example, a four-disk RAID 6 array with spare would require that you create the RAID 6 with the first four disks (from left to right) before moving to the next section to add the fifth hard disk as the spare.

1. Click the **Manage** button to launch the RAID Setup Wizard and **Standard** for a manual configuration.
2. Select the disks for your array by checking their respective boxes. Click **Next**.

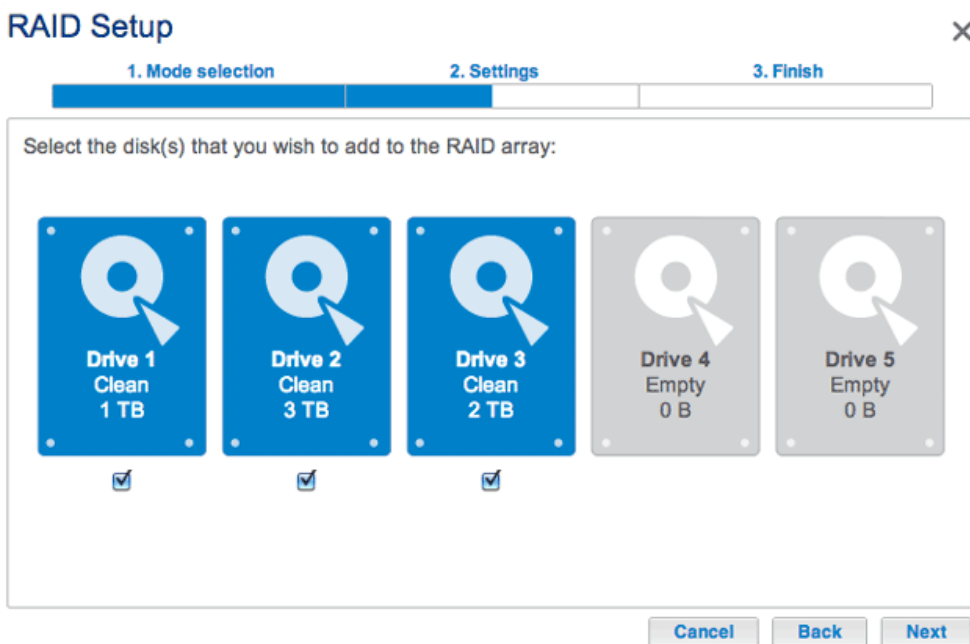

3. Choose a RAID level. Clicking the RAID mode's button will give you an explanation of its strengths and weaknesses. If you are reconfiguring the RAID, the new mode will erase files on existing shares but your Dashboard configuration will not be affected.

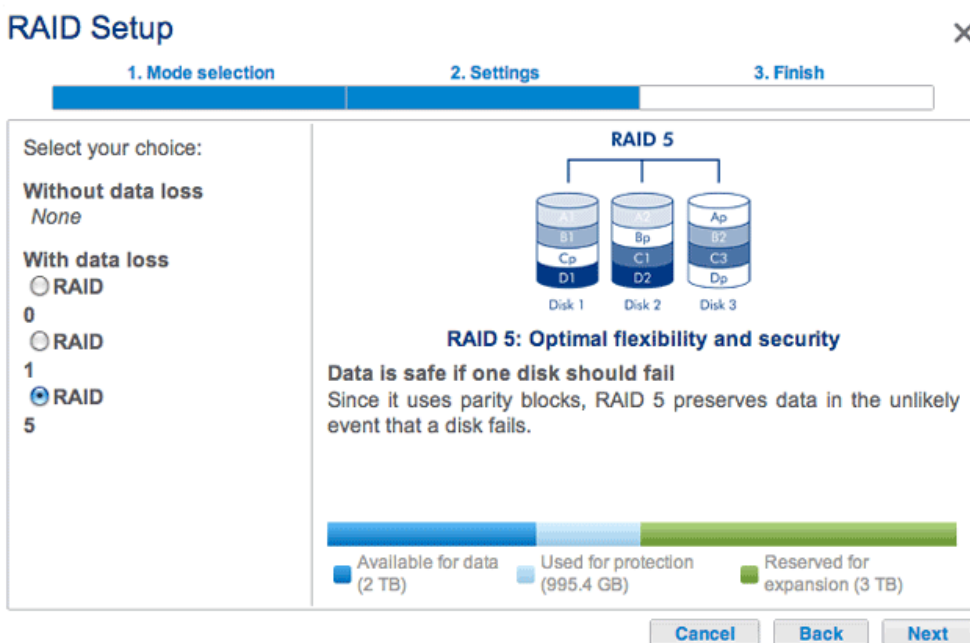

**Three-disk configuration includes: RAID 0, RAID 1, and RAID 5**

## RAID Setup



1. Mode selection      2. Settings      3. Finish

Select your choice:

**Without data loss**  
None

**With data loss**

RAID 0

RAID 5

RAID 6

**RAID 6**

**RAID 6: Maximum security**

**Data is safe if two disks should simultaneously fail**  
Since it uses two parity blocks, RAID 6 preserves data in the unlikely event that two disks fail at the same time.

Available for data (4 TB)    Used for protection (4 TB)    Reserved for expansion (0 B)

**Four- and five-disk configurations include: RAID 0, RAID 5, and RAID 6**

4. Click **Next**.
5. Review the information then confirm the RAID mode by clicking **Finish**. Click **Yes** at the final prompt.



## Manual RAID+Spare

Before adding a spare hard drive, you must follow the instructions above (**Standard (Manual)**) to create the array. When creating the array, please leave a minimum of one hard drive bay free for the spare. You may follow the directions below with RAID 1, RAID 5, or RAID 6 arrays.

1. If you have not inserted the spare hard drive(s) to the LaCie NAS, please see [Remove/Insert a Hard Disk](#) for instructions. To add the spare, **Dashboard > RAID** should display at least one *New* hard drive.

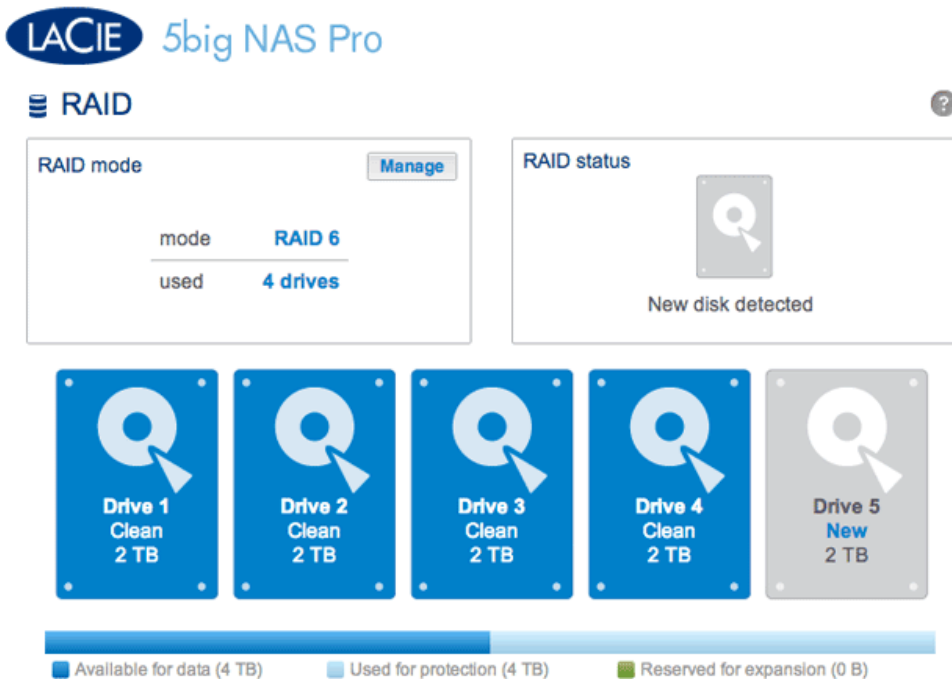

2. Click **Manage**.
3. Select **Standard (current)** and click **Next**.

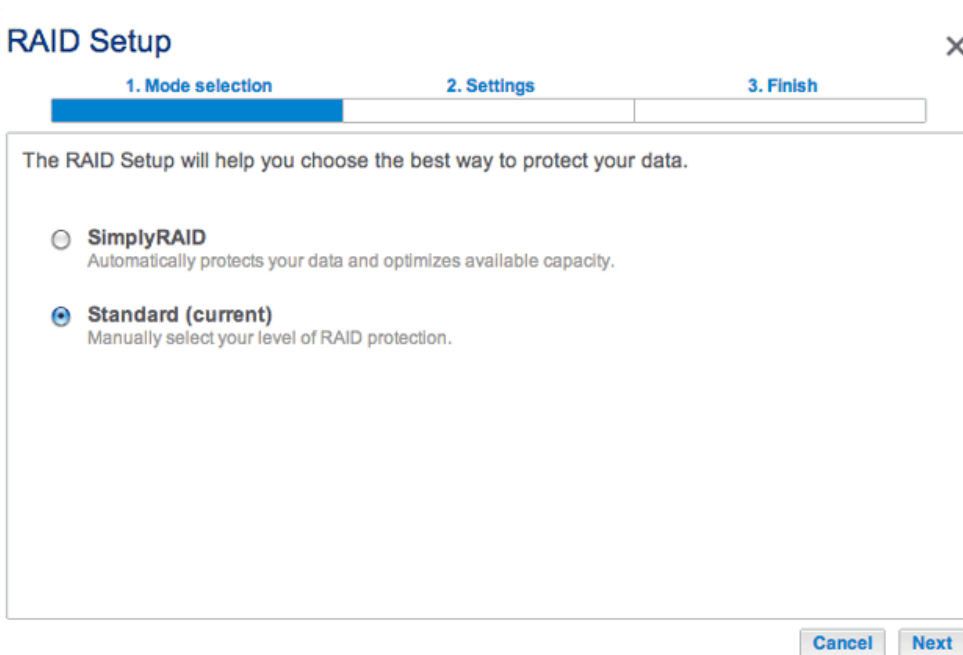

4. Make certain that all disks in the RAID array are selected.

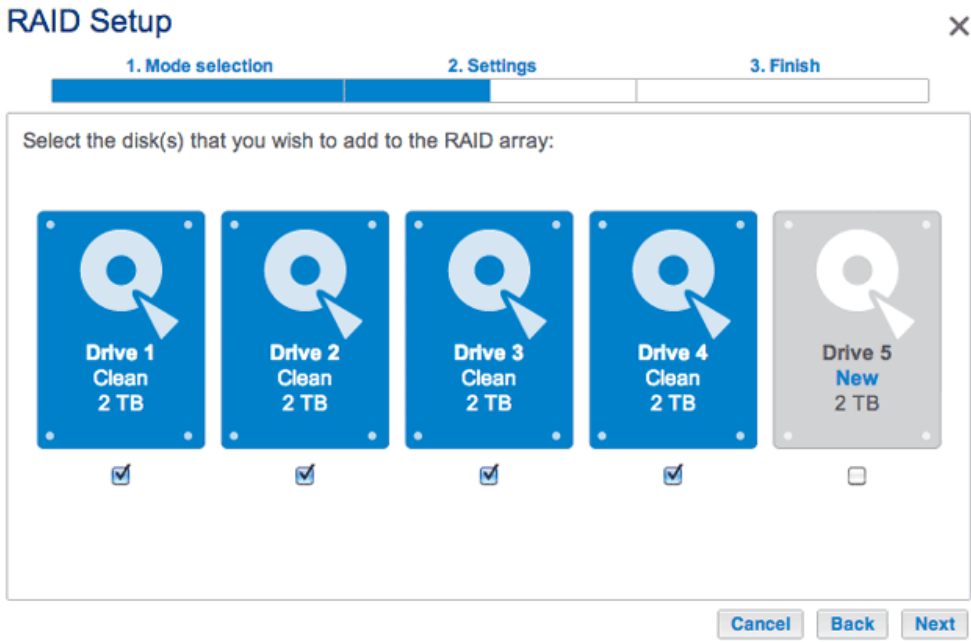

5. Check the box under the *New* hard drive(s) and click **Next**.

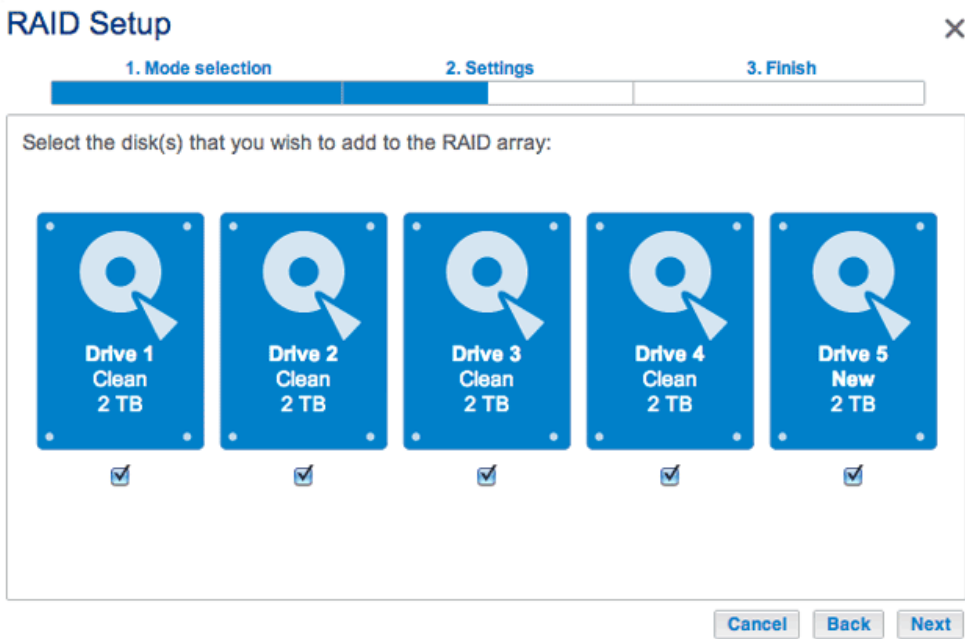

6. Confirm that your current RAID configuration is listed.

# RAID Setup



1. Mode selection

2. Settings

3. Finish

Select your choice:

Without data loss

RAID 6

Add a spare drive

With data loss

RAID 0

RAID 5

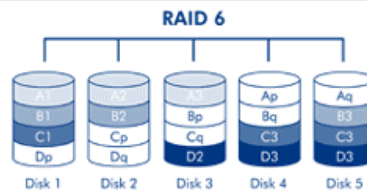

## RAID 6: Maximum security

Data is safe if two disks should simultaneously fail

Since it uses two parity blocks, RAID 6 preserves data in the unlikely event that two disks fail at the same time.



Cancel Back Next

7. Click on the radio button next to **Add a spare drive** and click **Next**.

# RAID Setup



1. Mode selection

2. Settings

3. Finish

Select your choice:

Without data loss

RAID 6

Add a spare drive

With data loss

RAID 0

RAID 5



## Spare: Fast rebuild

The system automatically replaces a failed disk

Add 1 drive like spare drive to the RAID configuration. A spare drive is inactive until an active drive fails.

Cancel Back Next

8. Confirm the configuration and click **Finish**.

# RAID Setup



1. Mode selection

2. Settings

3. Finish

Click FINISH to confirm your selection:

### Current RAID configuration

4 drives  
RAID 6  
4 TB



### Target RAID configuration

4 drives  
RAID 6  
4 TB  
1 spare drive

Data will be preserved.

Cancel Back Finish

9. The *Spare* is now available.

## LACIE 5big NAS Pro

### RAID



RAID mode

Manage

mode RAID 6  
used 5 drives

RAID status



Clean  
Protected if 2 disks fail

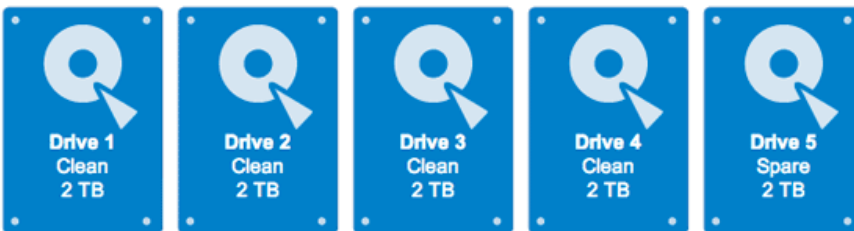

Available for data (4 TB)

Used for protection (4 TB)

Reserved for expansion (0 B)

## Rebuilding Times

Rebuilding a protected RAID array can take many hours, depending on the capacity of the hard disks and your LaCie NAS's available resources (concurrent tasks such as backups or torrent downloads will slow rebuilding). Changing to an unprotected RAID mode (e.g. RAID 0) takes less than five minutes. Note that data is accessible during rebuilding.

## RAID STATUS: EXPAND, REPLACE, AND RESET

The RAID Status box will inform you of changes to your array that may require action on your part. Follow the instructions below to:

- Remove and/or insert a disk
- Perform one of the following:
  - *Expand* your RAID with a new disk
  - *Replace* a missing or failed disk
  - *Reset* the RAID configuration with the available disks

**Important info:** If a hard disk that you have purchased from LaCie fails, please contact your LaCie reseller or LaCie Customer Support.

## Hard Disk Replacement/Expansion with Unprotected and Protected Arrays

### Unprotected RAID Arrays and Swapping/Expanding Hard Disks:

- Removing a hard disk from a RAID 0 array while the device is powered on may cause you to lose data. To avoid problems, shut down the LaCie NAS before removing healthy disks. Return the hard drives to their proper bays before powering on the LaCie NAS.
- In cases where a hard drive has failed or you wish to expand storage capacity, data will be lost when replacing/swapping hard disks.

**Protected RAID Arrays and Swapping/Expanding Hard Disks:** If your array is protected (e.g. RAID 1), you can remove a hard disk while the product is turned on without damaging the array and losing data, a process also referred to as “hot-swapping”. In most instances, LaCie recommends hot-swapping when replacing or expanding hard disks in the LaCie NAS. For example, if you swap or insert unclean hard drives (with data) from another LaCie NAS (e.g. a LaCie 2big NAS to a LaCie 5big NAS Pro), you may experience problems when first booting your current LaCie NAS.

When replacing or expanding hard drives in a protected RAID array:

- Perform the operation while the LaCie NAS is powered on (hot-swapping).
- Use clean hard drives (without data).

## Remove/Insert a Hard Disk

Disk Removal

**Caution:** After continuous use of the LaCie NAS, hard drives may be hot. Use caution when removing.

1. The hard drive tray may be locked. To unlock it, use the included disk drawer key to turn the lock until the slot is vertical.

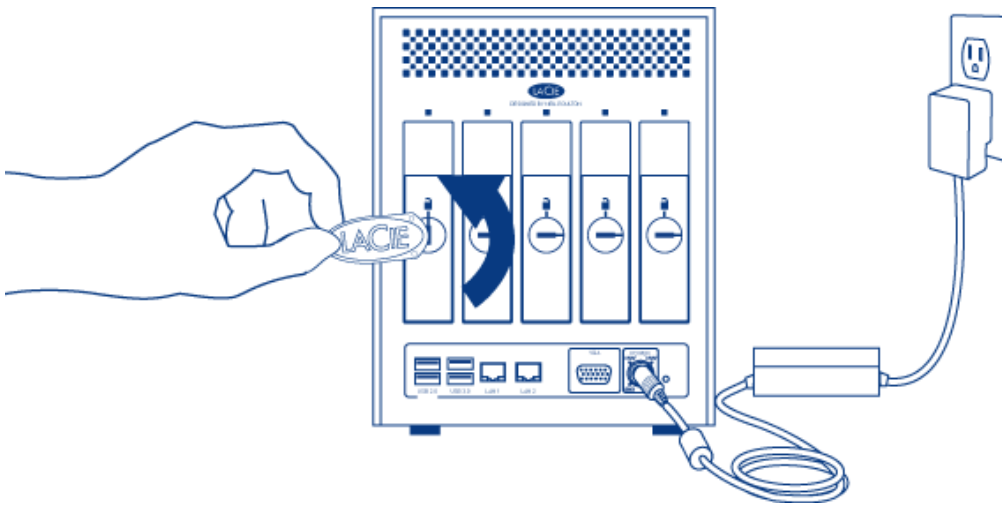

2. Draw out the hard drive tray by inserting your finger into the space behind the tray handle and pulling to disengage the tray.



3. Grasp the tray handle and carefully extract the drive.

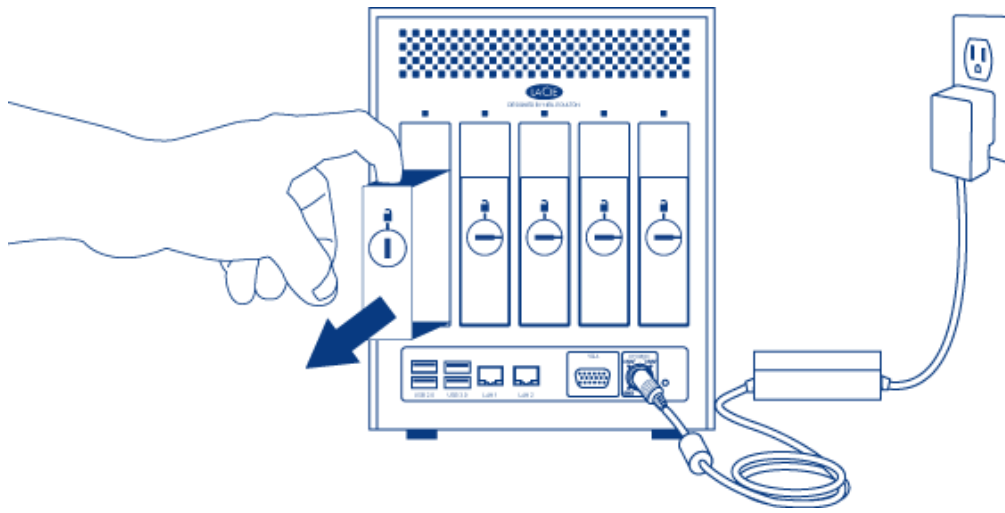

## Disk Insertion

1. Carefully insert the tray into an empty hard drive bay. When the tray is most of the way in and you feel resistance, press the drive tray handle firmly until you feel the drive snap into place and the drive tray handle is flush with the back of the LaCie NAS.

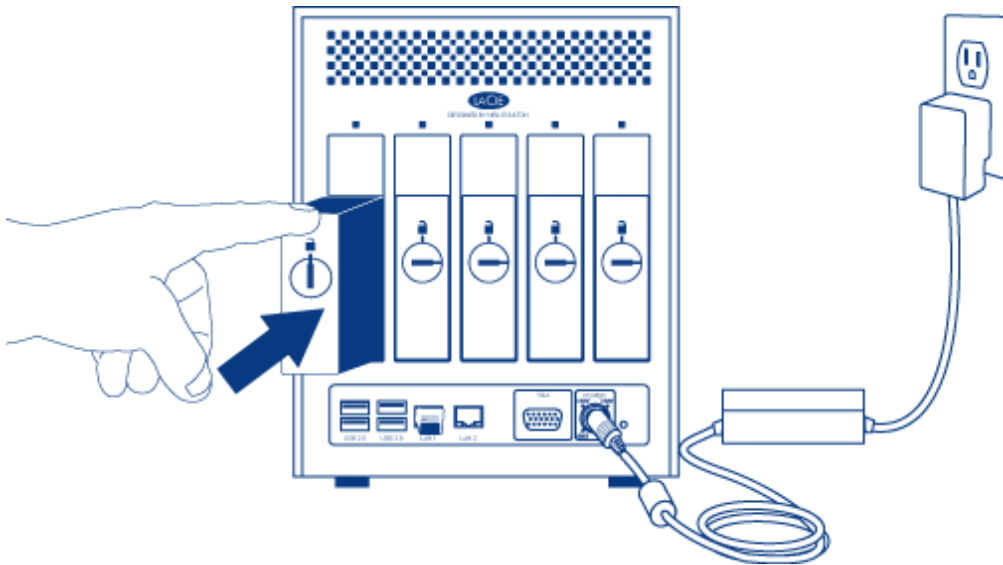

2. Use the disk drawer key to lock the drive.



## Expand your RAID array Hard Disk Capacity

### SimplyRAID

LaCie SimplyRAID allows you to expand your total storage capacity by removing hard disks (one at a time) and replacing them with larger capacity hard disks. It is not possible to replace existing hard disks with lower capacity hard disks. Please note that **data stored on the new disk will be deleted**.

The instructions below pertain to storage expansion in a LaCie 5big NAS Pro chassis with available or empty drive slots. If you are exchanging an existing hard disk in your array for a hard disk of greater capacity, please



follow the instructions in [Replace a failed or missing disk](#).

**Adding Hard Disks:** Please note that performing the steps below will **delete all data stored on the new, larger capacity hard disk**.

1. Insert a new hard drive into an available drive slot in your LaCie 5big NAS Pro (see [Remove/Insert a Hard Disk](#) for instructions). Please be patient while the LaCie NAS Dashboard gathers the information on the new hard disk.
2. Click on **Expand** in the RAID Status box.

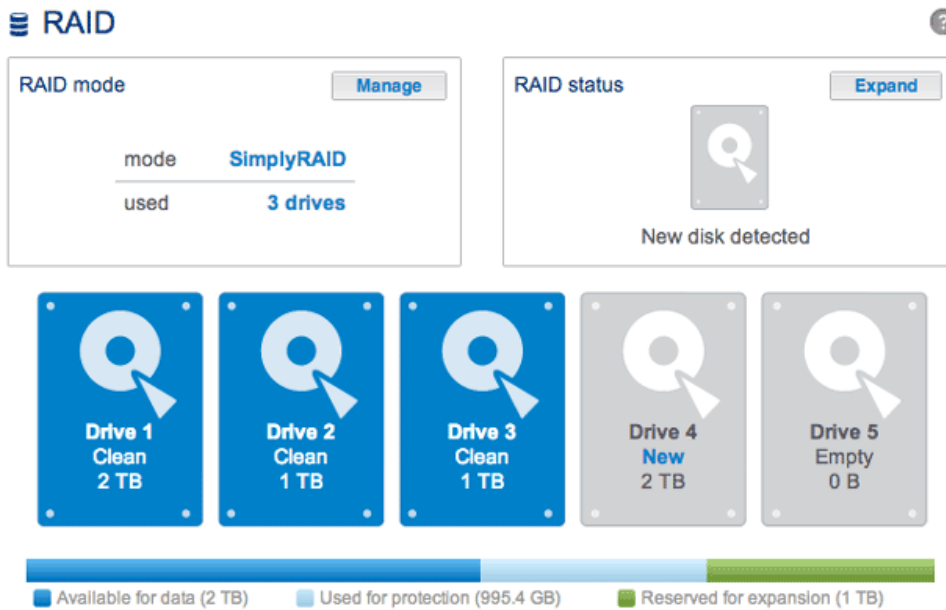

3. A prompt will ask you to confirm that you wish to add the disk to the array.

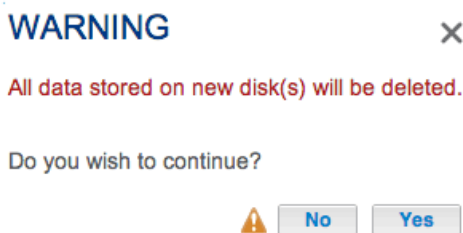

The Dashboard will become unavailable for a brief period of time as the system configures the RAID. You may continue to access files stored on your LaCie NAS during the RAID synchronization.

#### Manual

For instructions on how to exchange an existing hard drive in your protected RAID array for a larger capacity hard disk, please see the instructions for the LaCie 2big NAS: [Expand Disk Capacity](#).

For instructions on how to expand your protected RAID array once you have added a new hard disk to an available or empty drive slot, please see [RAID Setup Wizard](#). Select the **Manual+Spare** link and you will have the option to use the new disk as a Spare or to add the storage to the array.

Please make certain to select the radio button for your RAID array under the heading **Without data loss** (Step 6).

# RAID Setup



1. Mode selection

2. Settings

3. Finish

Select your choice:

**Without data loss**

- RAID 6
- Add a spare drive

**With data loss**

- RAID 0
- RAID 5

### RAID 6

**RAID 6: Maximum security**

Data is safe if two disks should simultaneously fail  
Since it uses two parity blocks, RAID 6 preserves data in the unlikely event that two disks fail at the same time.

Available for data (6 TB)

Used for protection (4 TB)

Reserved for expansion (0 B)

[Cancel](#) [Back](#) [Next](#)

## Replace a failed or missing disk

If you have configured your RAID as *Standard* (Manual as opposed to SimplyRAID), the new disk must have equal or greater capacity than the disk it is replacing.

1. Remove the failed disk and insert a new hard drive per the instructions above.
2. Go to **Dashboard > RAID**. The recently inserted hard disk will be labelled **New**.
3. If the LaCie 5big NAS Pro RAID configuration is SimplyRAID, RAID 1, RAID 5, or RAID 6:
  1. Click the **Replace** button below the New Disk. **DO NOT** click on *Reset*.

### RAID

**RAID mode** [Manage](#)

mode **SimplyRAID**

used **5 drives**

**RAID status** [Reset](#)

Degraded ⓘ

**Drive 1**  
New  
2 TB

**Drive 2**  
Clean  
3 TB

**Drive 3**  
Clean  
2 TB

**Drive 4**  
Clean  
1 TB

**Drive 5**  
Clean  
1 TB

[Replace](#)

Available for data (5 TB)

Used for protection (1 TB)

Reserved for expansion (1 TB)

2. Confirm the addition and complete the RAID Setup Wizard.

## WARNING



The disk will be added to the RAID Array. All data contained on the new disk will be lost.

Do you wish to continue?



No

Yes

3. You may continue to use the LaCie NAS during the RAID synchronization.
4. If the LaCie 5big NAS Pro RAID configuration is RAID 0:
  1. Click the **Manage** button and complete the RAID Setup wizard.

The Dashboard will become unavailable for a brief period of time as the system configures the RAID. On protected RAID arrays, you may continue to access files stored on your LaCie NAS during the RAID synchronization.

## Reset the RAID array (SimplyRAID only)

LACIE 5big NAS Pro

RAID

RAID mode **Manage**

mode **SimplyRAID**

used **5 drives**

RAID status **Reset**

Degraded ⓘ

Drive 1 **Missing** 0 B ⓘ

Drive 2 Clean 3 TB

Drive 3 Clean 2 TB

Drive 4 Clean 1 TB

Drive 5 Clean 1 TB

Available for data (5 TB) Used for protection (1 TB) Reserved for expansion (1 TB)

If a hard drive in the array fails and you do not have a replacement disk, you can use the **Reset** button to reconfigure the RAID. The Reset button will optimize the RAID configuration using the remaining disks. LaCie recommends that you back up your files since all data will be deleted while creating the new RAID array.

## 2BIG NAS: ABOUT RAID MODES

Refer to the table below for an overview of RAID modes available to the LaCie 2big NAS. Note that the levels of performance and protection will differ based upon the number of drives in the volume. The *New storage volume* wizard includes a helpful tooltip with star ratings for performance and protection.

RAID Mode	Minimum Hard Drives	Factory Default (full disk version only)
JBOD	1	-
RAID 0	2	-
RAID 1	1 (no data protection)	-
RAID 1	2 (data protection)	Yes

**Note on enclosures with one hard drive:** You can create a JBOD or RAID 1 volume with a single drive in the enclosure. However, there is NO DATA PROTECTION with RAID 1 since a second drive is not available. A JBOD volume with one or more hard drives does not offer data protection.

**Important info on NAS backup:** It is recommended that all users back up data to DAS or another NAS as further protection against disk failure or secondary points of failure (e.g. hardware, network, etc.) See [Backup Jobs](#) for details.

## JBOD (Just a Bunch of Disks)

Disks in a JBOD configuration store data sequentially. For example, data is written to Disk 1 first. Once Disk 1 is full, data will be written to Disk 2. Two advantages to this level of RAID are the availability of 100% of the disks' total storage capacity and easy expansion. However, all data will be lost if a single disk fails.

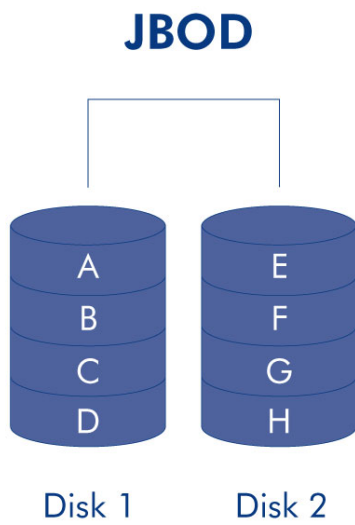

## RAID 0

RAID 0 is the fastest RAID mode since it writes data across both of the volume's disks. The capacities of each disk are also added together for optimal data storage. While RAID 0 gives you higher performance and data capacity than RAID 1, it lacks data protection. If one disk fails, all data becomes inaccessible.

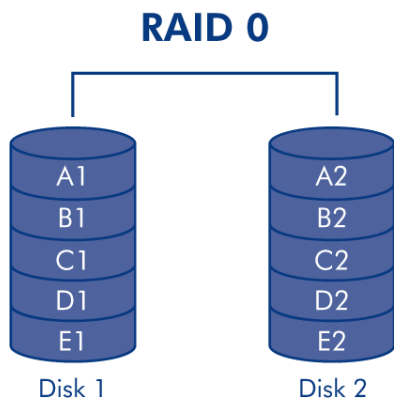

## RAID 1

RAID 1 provides enhanced data security since all data is written to each disk in the volume. If a single disk fails, data remains available on the other disk in the volume. However, due to the time it takes to write data twice, performance is reduced when compared with RAID 0. Additionally, RAID 1 reduces the available disk space by 50% since each bit of data is stored on both disks in the volume.

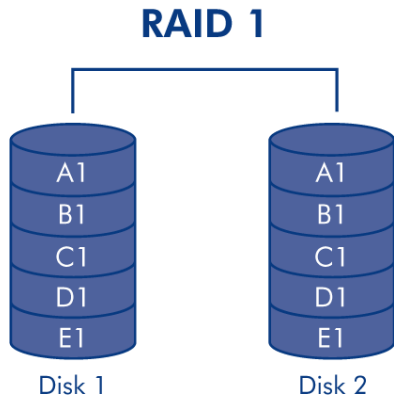

**Note on RAID 1 disk requirements:** A standard RAID 1 configuration includes two disks of equal capacity. When using disks of unequal capacities, the available storage space for data is that of the smaller disk.

It is possible to create a RAID 1 volume using a single disk. While such a volume cannot provide any data protection, it is ready for expansion when you add a new disk. Data protection would become available once the second disk is added to the RAID 1 volume.

# NEW STORAGE VOLUME WIZARD

Build one or two volumes using the *New storage volume wizard*. You can select:

- JBOD
- RAID 0 (two disks minimum)
- RAID 1 (two disks minimum for data protection)

**Important note on creating a single-disk volume:** Single-disk volumes can be created with expansion in mind. For example, you can use the *New storage volume wizard* to create a single-disk volume using JBOD or RAID 1. Though the volume will not provide data protection in a single-disk RAID 1 configuration, it is prepared for expansion when you add a second disk to the enclosure.

**Important info:** It is recommended that all users back up data to DAS or another NAS as further protection against disk failure or secondary points of failure (e.g. hardware, network, etc.) See [Backup Jobs](#) for details.



One disk

Install the disk into the enclosure before following the directions below. For instructions, see [Remove/Insert a Hard Disk](#) or [Connect to the Network: Diskless LaCie 2big NAS](#).

1. Select **One new disk** at the top of the left-hand column, then choose **Add storage**.

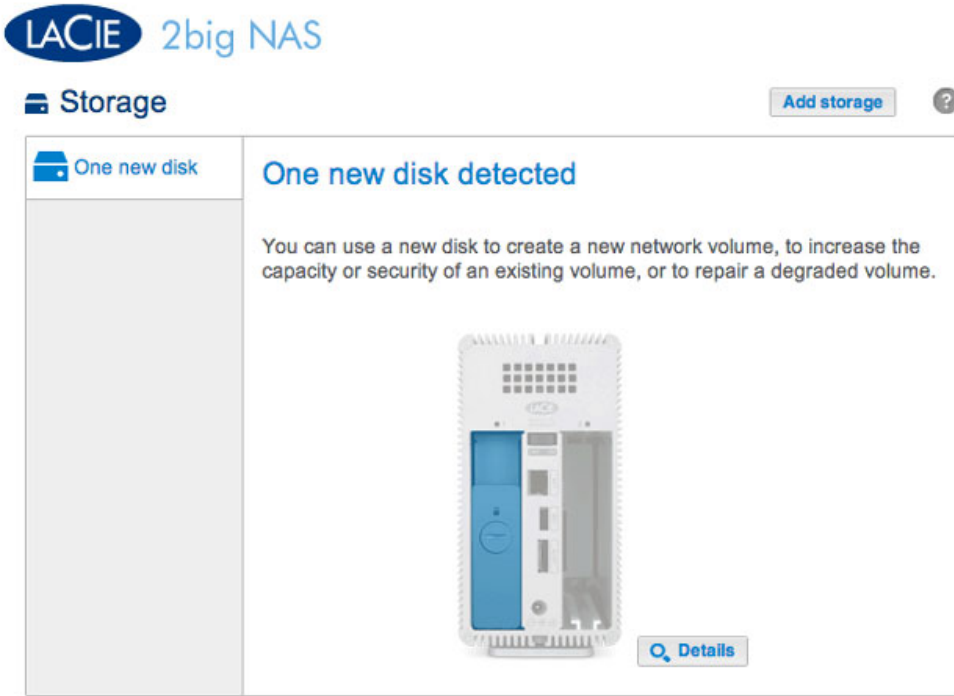

2. Select **Network volume** then choose **Next**.

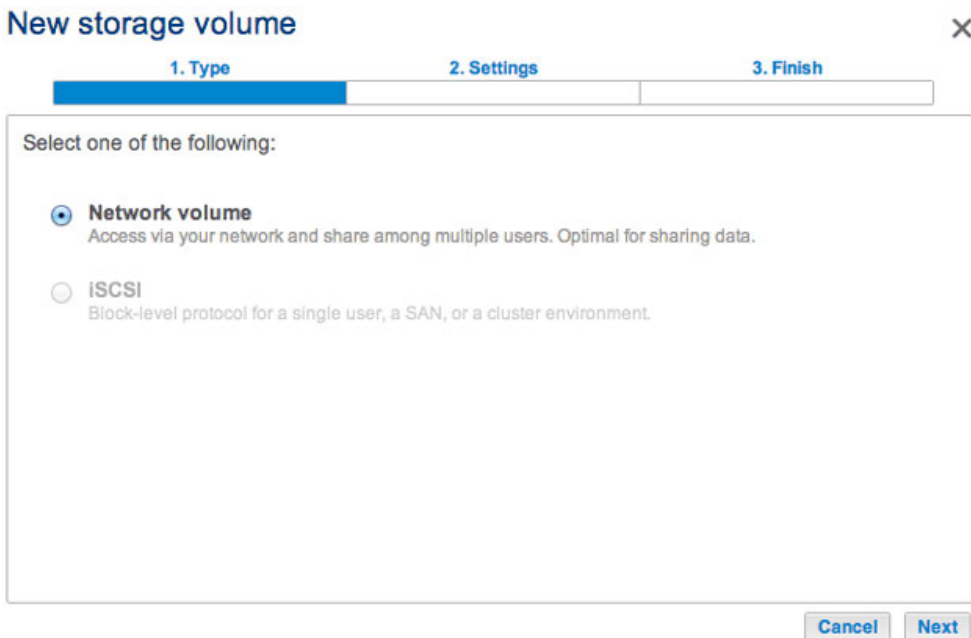

3. Select the check box under the new disk then choose **Next**.

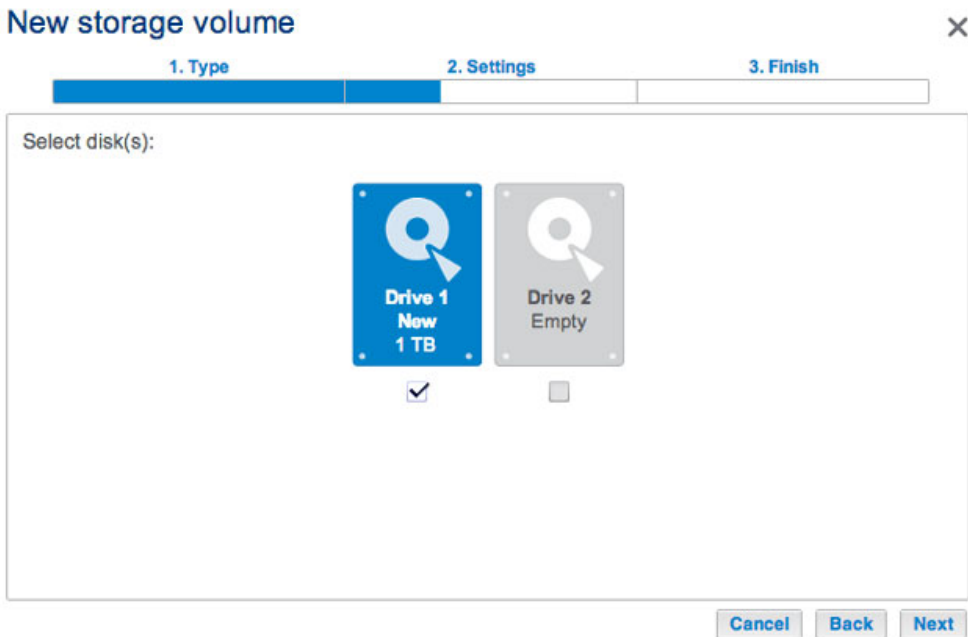

4. The RAID selection window helps you to select the optimal configuration for your environment:
  - Select a RAID mode's radio button to view an explanation of its strengths and weaknesses.
  - Use the cursor to choose the grey *i* tooltip to see a graphic summary of the strengths and weaknesses of each level of RAID.
5. Select JBOD or RAID 1, then choose **Next**.

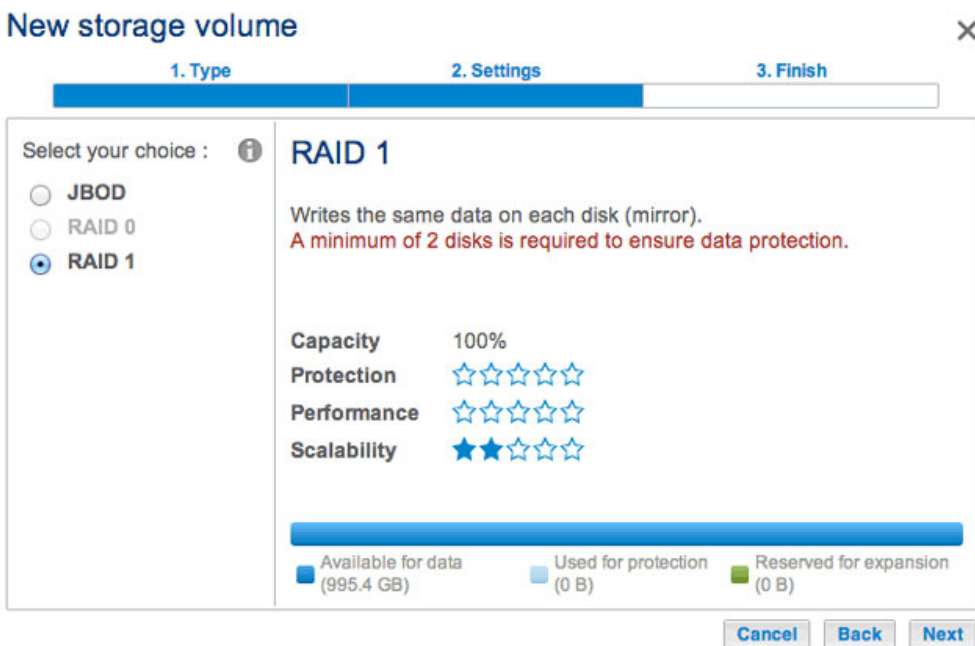

6. Review the summary window then choose **Finish**. A popup window cautions you that all data on the selected disk will be deleted to create the volume. Select **Yes** to build the volume.

## New storage volume



1. Type

2. Settings

3. Finish

Click Finish to confirm your selection.

Selected drive	Drive 1
RAID mode	RAID 1
Protection	No data protection
Available for data	995.4 GB
Used for protection	0 B
Reserved for expansion	0 B

All data on the selected disks (Drive 1) will be erased.

To expand a single-disk volume, see [Hard Disk Expansion](#).

Two disks

Install disks into the enclosure before following the directions below. For instructions, see [Remove/Insert a Hard Disk](#) or [Connect to the Network: Diskless LaCie 2big NAS](#).

1. Choose **Add storage** to launch the *New storage volume* wizard.



2. Select **Network volume**, then choose **Next**.

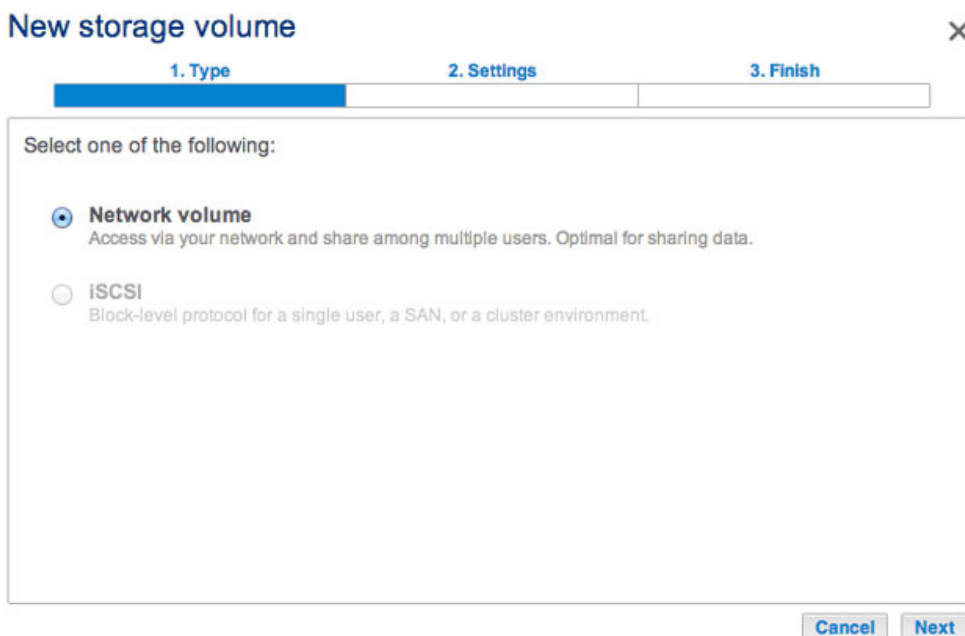

3. The *Select disks* window lists all the disks in the enclosure. Select the box under each disk then choose **Next**. All data on the disks will be deleted to create the RAID configuration.



4. The RAID selection window helps you to select the optimal configuration for your environment:
  - Select a RAID mode's radio button to view an explanation of its strengths and weaknesses.
  - Use the cursor to choose the grey *i* tooltip to see a graphic summary of the strengths and weaknesses of each level of RAID.
5. Select the level of RAID that you want then choose **Next**. Note, if you are reconfiguring an existing RAID, the new mode will erase files on the shares but your Dashboard configuration will not be affected.

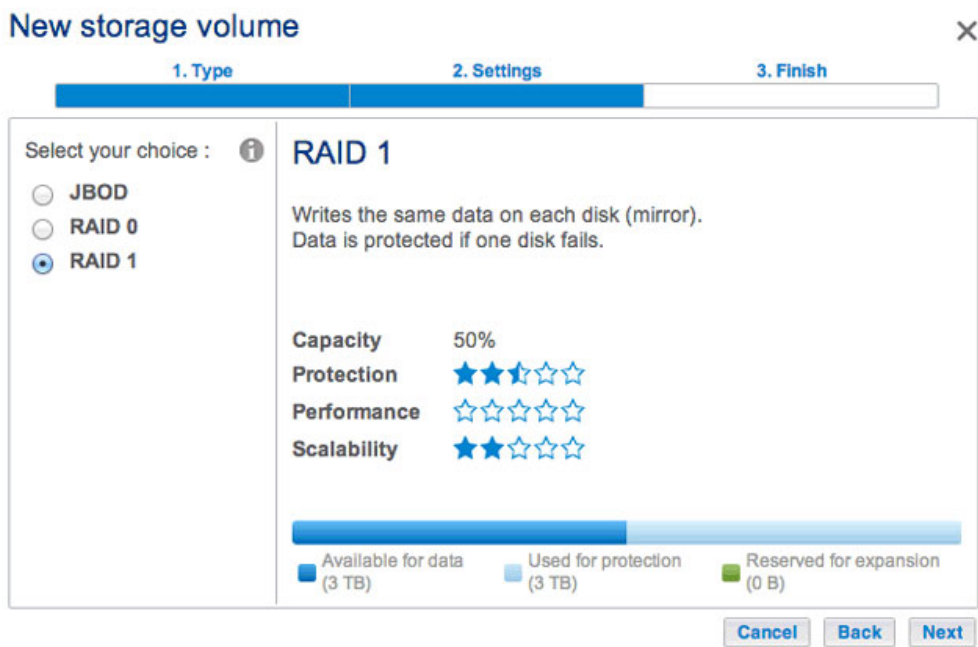

6. Review the summary window then choose **Finish**. A popup window cautions you that all data on the selected disks will be deleted to create the volume. Select **Yes** to build the RAID.

# New storage volume



1. Type

2. Settings

3. Finish

Click Finish to confirm your selection.

Selected drive	Drive 1, Drive 2
RAID mode	RAID 1
Protection	Protected if one disk fails
Available for data	3 TB
Used for protection	3 TB
Reserved for expansion	0 B

All data on the selected disks (Drive 1, Drive 2) will be erased.

[Cancel](#) [Back](#) [Finish](#)

# HARD DISK EXPANSION

## REMOVING HEALTHY DISKS FROM A RAID VOLUME

### Unprotected volumes (Single-disk volume, RAID 0, or JBOD):

- **Removing the sole disk in a single-disk volume will break the RAID and all data will be lost.** Since NAS OS is installed on the hard drive, you will lose connection to the device if the only disk in the enclosure is removed while the device is powered on. Try to shut the NAS off then reinsert the disk. Power on the device and wait approximately five minutes before logging on to the Dashboard.
- **Removing a healthy hard disk from an unprotected volume while the LaCie 2big NAS is powered on will break the RAID and all data will be lost.** To avoid problems, shut down the LaCie NAS before removing healthy disks. Return the hard drives to their proper bays before powering on the LaCie NAS.
- Powering on the LaCie 2big NAS with a missing disk in an unprotected volume will break its RAID and all data will be lost.

### Protected volumes:

- **Removing a healthy hard disk from a protected volume while the LaCie 2big NAS Pro is powered on will render the volume unprotected.** You can remove a disk from a protected volume to expand capacity or replace a failed disk (see [Hard Disk Expansion and Replacement](#) for details). Otherwise, shut down the LaCie NAS before removing healthy disks. Return the hard drives to their proper bays before powering on the LaCie NAS.
- If a healthy disk has been removed while the LaCie 2big NAS is powered on and you do not want to replace it, you can reinsert it into the enclosure slot. Data remains intact as the volume's hard disks synchronize.

**Important info:** If a hard disk that you have purchased from LaCie fails, please contact your LaCie reseller or LaCie Customer Support.

**Important info on NAS backup:** It is recommended that all users back up data to DAS or another NAS as further protection against disk failure or secondary points of failure (e.g. hardware, network, etc.) See [Backup Jobs](#) for details.

## EXPAND THE RAID BY ADDING A SECOND DISK TO THE ENCLOSURE

Select your RAID below to add the new disk to an existing volume.

### RAID 0

A RAID 0 volume cannot be expanded with new disks added to the enclosure and/or swapped for disks of higher capacity. Doing so will break the RAID 0 volume and destroy all of its data. Additionally, data will be lost in a RAID 0 volume if one of its disks fails. In such a case, you can replace the failed disk and create a new RAID volume (see [New Storage Volume Wizard](#) for instructions).

### JBOD



The screenshot above shows a single-disk volume configured for JBOD (for instructions on how to change the name of the volume from the default to *JBOD*, see [Volume Tools](#)). A JBOD volume can be expanded with a new disk added to the LaCie 2big NAS enclosure. Follow the steps below to add a drive to your JBOD volume:

1. Insert a new hard drive into the available drive slot in your LaCie 2big NAS (see [Remove/Insert a Hard Disk](#) for instructions). Following the disk installation, the **Dashboard > Storage** page should display at least one *New hard drive*.



2. Choose **Manage**.
3. Select **Add drive** then choose **Next**.



## Manage volume: JBOD



1. Action

2. Settings

3. Finish

Select one of the following:

- Add drive**  
Expand the storage capacity by adding drives.
- Repair**  
To repair a degraded volume
- Optimize storage capacity**  
To increase the size available for data using the reserved for expansion space

Cancel Next

4. Select the new hard drive(s) then choose **Next**.

## Manage volume: JBOD



1. Action

2. Settings

3. Finish

Select the disks that you want to add to the volume:

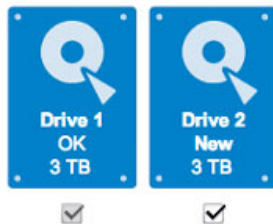

Cancel Back Next

5. Review the summary page then choose **Finish**. Choose **Yes** at the prompt to confirm the RAID.

# Manage volume: JBOD



1. Action

2. Settings

3. Finish

Click Finish to confirm your selection.

Selected drive	Drive 2
RAID mode	JBOD
Protection	No data protection
Available for data	6 TB ⓘ
Used for protection	0 B
Reserved for expansion	0 B

All data on the selected disks (Drive 2) will be erased.

[Cancel](#) [Back](#) [Finish](#)

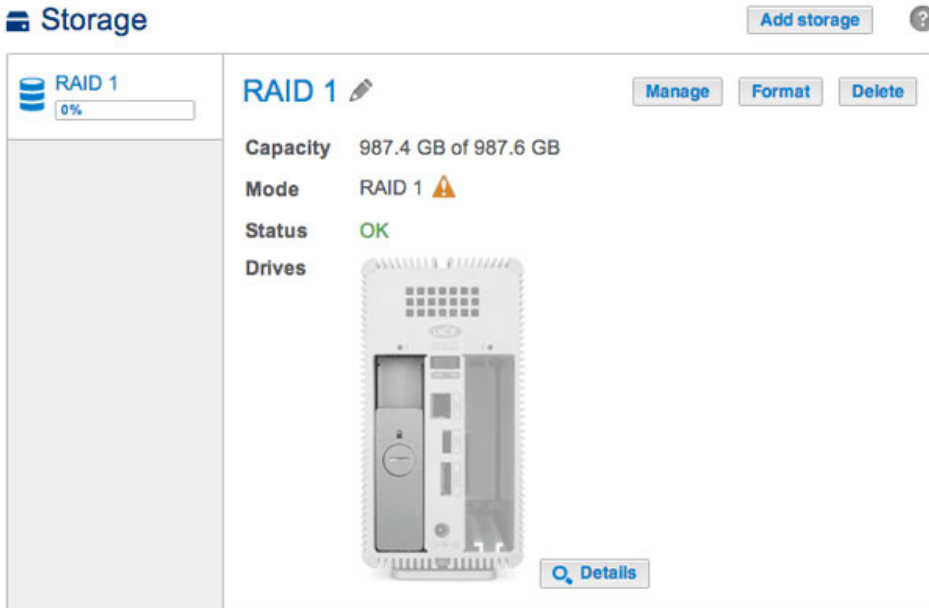

The screenshot above shows a single-disk volume configured for RAID 1 (for instructions on how to change the name of the volume from the default to *RAID 1*, see [Volume Tools](#)). Follow the steps below to add a second drive:

1. Insert a new hard drive into the available slot in your LaCie 2big NAS (see [Remove/Insert a Hard Disk](#) for instructions). Following the disk installation, the **Dashboard > Storage** page should display the *New* hard drive.

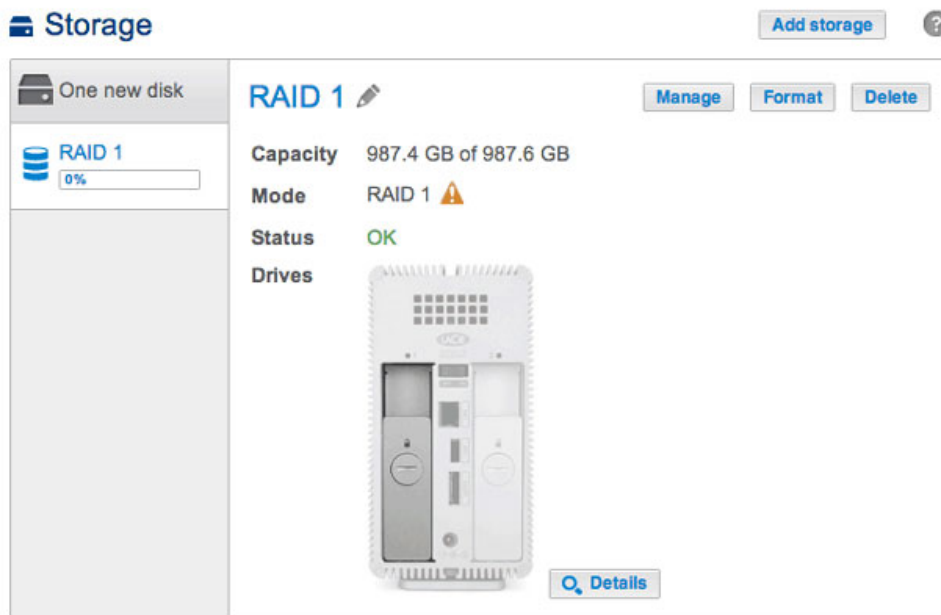

2. Choose **Manage**.
3. Select **Add drive** then choose **Next**.

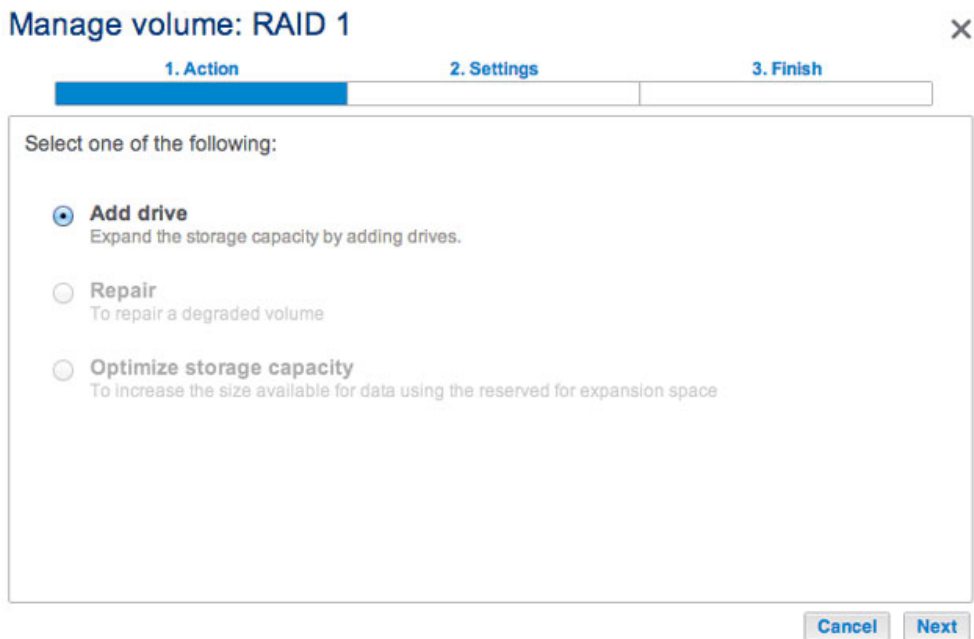

4. Select the new hard drive then choose **Next**.

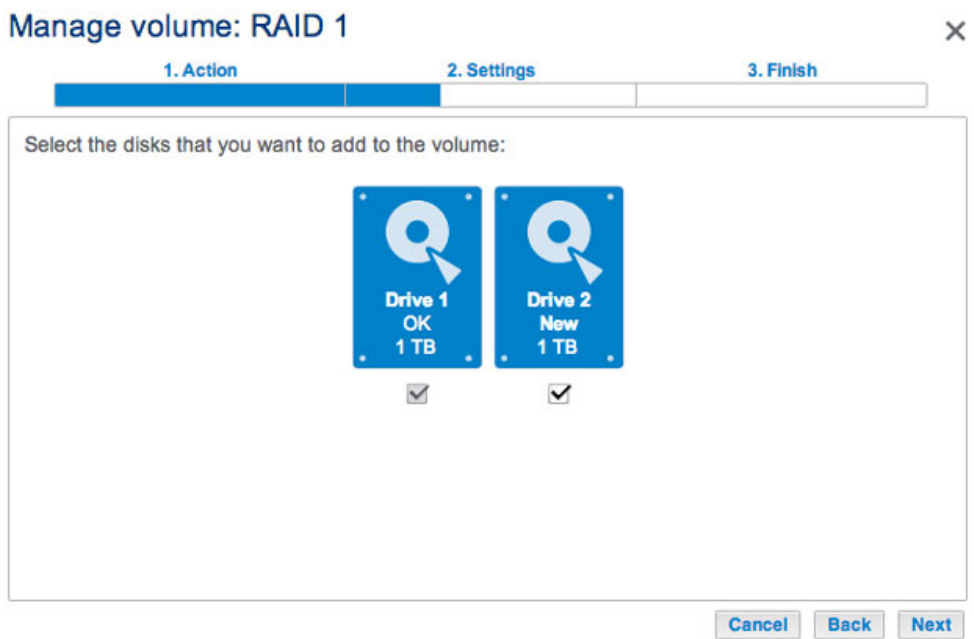

5. Select **Increase security** then choose **Next**. IMPORTANT: Choosing **Custom** will bring you to the RAID selection menu. Selecting any RAID configuration via the **Custom** menu will delete all media stored on the original drive.

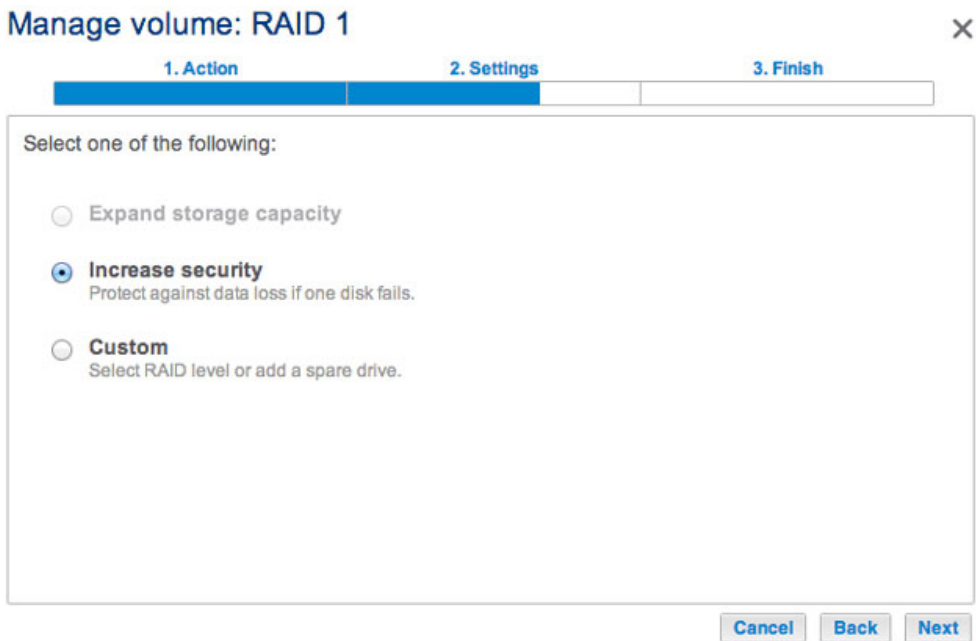

6. Review the summary page then choose **Finish**. Choose **Yes** at the prompt to confirm the RAID.

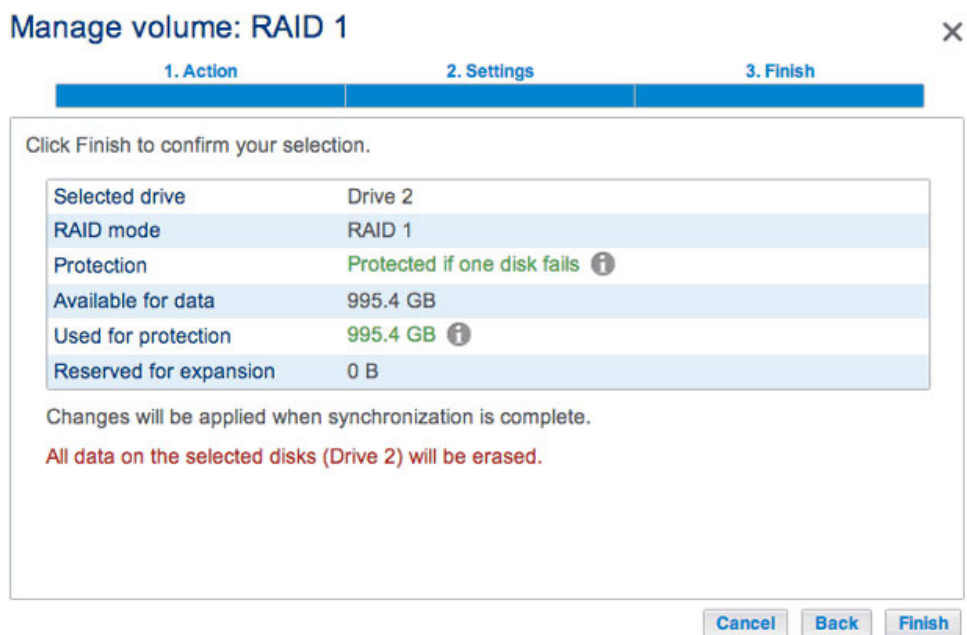

You can use the volume during the RAID syntonization.

## HARD DISK EXPANSION AND REPLACEMENT

Use the directions below to replace a hard disk that is:

- Healthy. Exchange a disk in the volume with a larger capacity hard drive.
- Failed or missing. Replace a hard drive that has failed or is missing.

## HOT-SWAPPING HARD DRIVES

You can remove one hard disk from a protected volume while the product is turned on without losing data. This process is referred to as “hot-swapping”. It is highly recommended that hot-swapping be performed when replacing or expanding a hard disk that is part of a protected volume. You can experience problems if you shut down the LaCie 2big NAS to replace a hard drive with an “unclean” hard drive (with data) from another LaCie NAS or a third-party NAS. In such a case, the NAS OS may become confused and remain frozen as it boots.

When replacing or expanding hard drives in a protected RAID volume:

- Perform the operation while the LaCie NAS is powered on (hot-swapping).
- Use clean hard drives (without data).

## RAID 0

A RAID 0 volume cannot be expanded using disks of higher capacity. Attempting to do so can delete all data on the volume. If one of the disks in a RAID 0 volume fail, all data is lost.

Replace the failed disk and see [New Storage Volume Wizard](#) for instructions on creating a new volume.

## JBOD

A JBOD volume cannot be expanded using disks of higher capacity. Attempting to do so can delete all data on the volume. If one of the disks in a JBOD volume fail, all data is lost.

Replace the failed disk and see [New Storage Volume Wizard](#) for instructions on how to create a new volume.



## Storage

[Add storage](#)

**RAID 1**

0%

**RAID 1**

[Manage](#) [Format](#) [Delete](#)

**Capacity** 987.4 GB of 987.6 GB

**Mode** RAID 1

**Status** OK

**Drives**

[Details](#)

Expand or repair a two-disk volume that has been configured for RAID 1.

The example below will demonstrate how to expand the capacity of a RAID 1 volume from two 1TB hard disks to two 3TB disks. If you are expanding the capacity of your hard disks, make certain to follow all three phases of the update: replace one disk; replace the second disk; and optimize storage capacity. You can also follow the directions to repair a failed hard drive.

**Note on RAID expansion and synchronizing:** The volume must synchronize twice when expanding capacity on a protected RAID volume.

### Phase 1: Replace the first disk

1. Remove the disk that you want to replace. The Storage page will alert you that the volume is no longer protected.



Storage

Add storage



RAID 1

0%

RAID 1

Manage Format Delete

**Capacity** 987.4 GB of 987.6 GB

**Mode** RAID 1

**Status** No data protection

**Drives**

[Details](#)

Storage

Add storage



RAID 1

0%

RAID 1

Manage Format Delete

**Capacity** 987.4 GB of 987.6 GB

**Mode** RAID 1

**Status** No data protection

**Drives**

**Drive details** ✕

Drive	Status	Capacity
1	OK	1 TB
2	Missing	-

- Insert the replacement disk per the instructions provided in [Remove/Insert a Hard Disk](#). The new drive will be listed on the Storage page.

Storage

Add storage



One new disk

RAID 1

Manage Format Delete

Capacity 987.4 GB of 987.6 GB

Mode RAID 1

Status **No data protection**

Drives

[Details](#)

3. Choose **Manage**.
4. Select **Repair** and choose **Next**.

Manage volume: RAID 1



1. Action

2. Settings

3. Finish

Select one of the following:

- Add drive**  
Expand the storage capacity by adding drives.
- Repair**  
To repair a degraded volume
- Optimize storage capacity**  
To increase the size available for data using the reserved for expansion space

Cancel

Next

5. Select the replacement disk then choose **Next**.

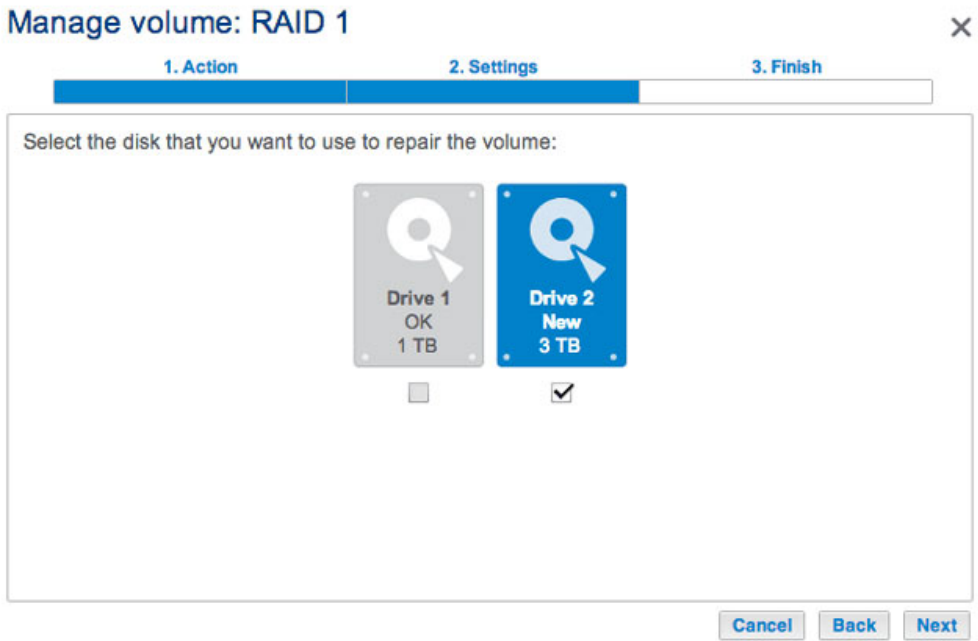

6. Choose **Finish**, then **Yes** at the prompt to confirm the replacement disk. The time to synchronize the volume depends upon the amount of disks and the total capacity.

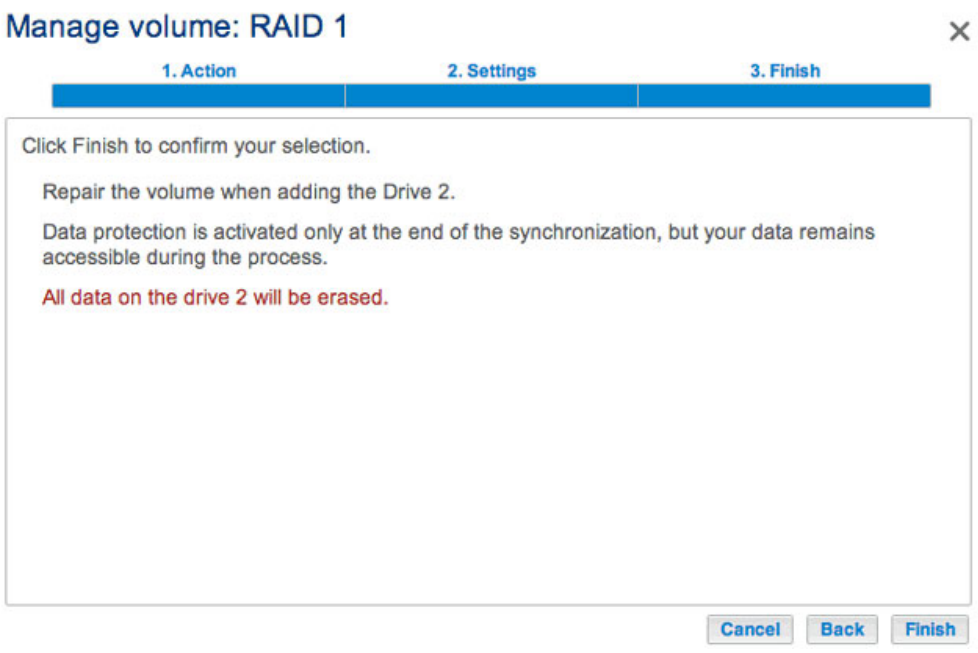

7. The synchronization is complete once the *Status* is **OK**. Choosing **Details** shows that the storage distribution has been changed. Move on to the next phase.

Storage

Add storage



**RAID 1**

0%

**RAID 1**

Manage Format Delete

**Capacity** 987.4 GB of 987.6 GB

**Mode** RAID 1

**Status** OK

**Drives**

[Details](#)

Storage

Add storage



**RAID 1**

0%

**RAID 1**

Manage Format Delete

**Capacity** 987.4 GB of 987.6 GB

**Mode** RAID 1

**Status** OK

**Drives**

**Drive details**

Drive	Status	Capacity
1	OK	1 TB
2	OK	3 TB

■ Available for data (987.6 GB)
 ■ Used for protection (995.4 GB)
 ■ Reserved for expansion (2 TB)

**Storage distribution has changed with the new disk**

**Phase 2: Replace the second disk**

1. Remove the second disk. The Storage page will alert you that the volume is no longer protected.

Storage

Add storage



RAID 1 0%

RAID 1

Manage Format Delete

Capacity 987.4 GB of 987.6 GB

Mode RAID 1

Status **No data protection**

Drives



[Details](#)

2. Insert the replacement disk per the instructions provided in [Remove/Insert a Hard Disk](#). The new drive will be listed on the Storage page.

Storage

Add storage



One new disk

RAID 1 0%

RAID 1

Manage Format Delete

Capacity 987.4 GB of 987.6 GB

Mode RAID 1

Status **No data protection**

Drives



[Details](#)

3. Choose **Manage**.
4. Select **Repair** and choose **Next**.

## Manage volume: RAID 1



1. Action      2. Settings      3. Finish

Select one of the following:

- Add drive**  
Expand the storage capacity by adding drives.
- Repair**  
To repair a degraded volume
- Optimize storage capacity**  
To increase the size available for data using the reserved for expansion space



5. Select the replacement disk then choose **Next**.

## Manage volume: RAID 1



1. Action      2. Settings      3. Finish

Select the disk that you want to use to repair the volume:

 <b>Drive 1</b> New 3 TB	 <b>Drive 2</b> OK 3 TB
<input checked="" type="checkbox"/>	<input type="checkbox"/>

6. Choose **Finish**, then **Yes** at the prompt to confirm the replacement disk. The time to synchronize the volume depends upon the amount of disks and the total capacity.

## Manage volume: RAID 1



1. Action

2. Settings

3. Finish

Click Finish to confirm your selection.

Repair the volume when adding the Drive 1.

Data protection is activated only at the end of the synchronization, but your data remains accessible during the process.

All data on the drive 1 will be erased.

Cancel

Back

Finish

7. The synchronization is complete once the *Status* is **OK**. Move on to the next phase.



Storage

Add storage



The screenshot shows the 'Storage' section of the LaCie management interface. On the left, there is a sidebar with a 'RAID 1' icon and a progress indicator at '0%'. The main area displays the RAID configuration for 'RAID 1'. It includes a 'Capacity' of 987.4 GB of 987.6 GB, a 'Mode' of RAID 1, and a 'Status' of OK. Below this information is an image of the LaCie 2big NAS device with two drive bays. To the right of the device image is a 'Details' button. At the top right of the main area, there are 'Manage', 'Format', and 'Delete' buttons. At the top left of the main area, there is an 'Add storage' button and a help icon.

**Phase 3: Optimize storage capacity** Now that the two drives have been replaced, you can optimize the RAID for the expanded capacity.

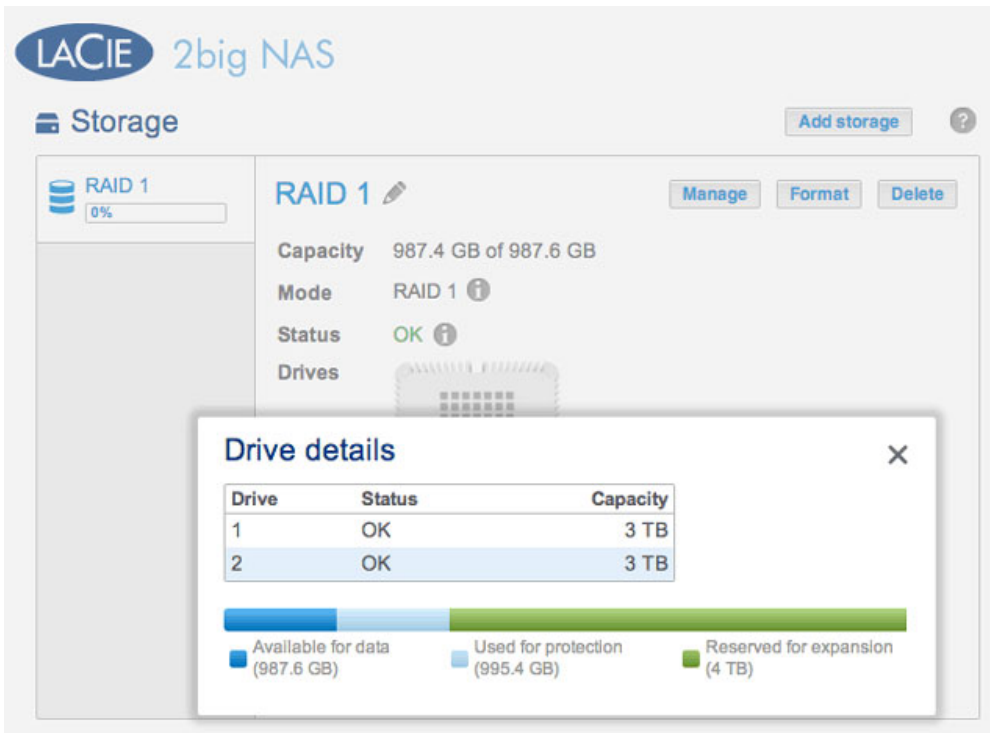

*The storage capacity must be optimized for the new disks*

1. Choose **Manage**.
2. Select **Optimize storage capacity** and choose **Next**.

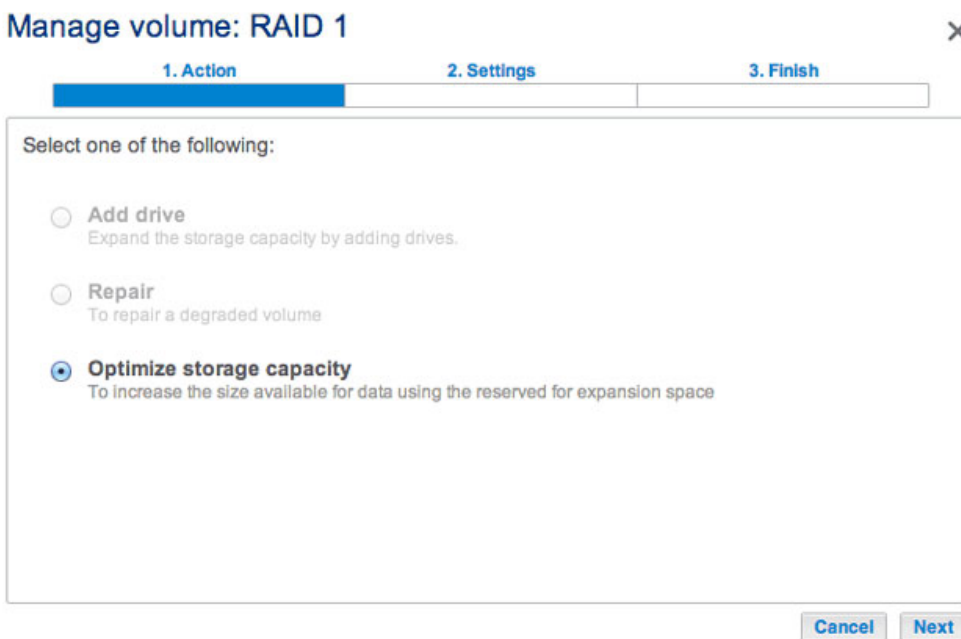

3. Choose **Finish**.



## Manage volume: RAID 1



1. Action

2. Settings

3. Finish

Click Finish to confirm your selection.

Use reserved for expansion. You will gain approximately 2 TB following the synchronization:



■ Available for data (3 TB)   ■ Used for protection (3 TB)   ■ Reserved for expansion (0 B)

Cancel

Back

Finish

4. The volume will synchronize once more to update the storage capacity.  
You can access files stored on your LaCie NAS during the RAID synchronization.

# REMOVE/INSERT A HARD DISK

**Important info:** If a hard disk that you have purchased from LaCie fails, please contact your LaCie reseller or LaCie Customer Support.

## Disk Removal

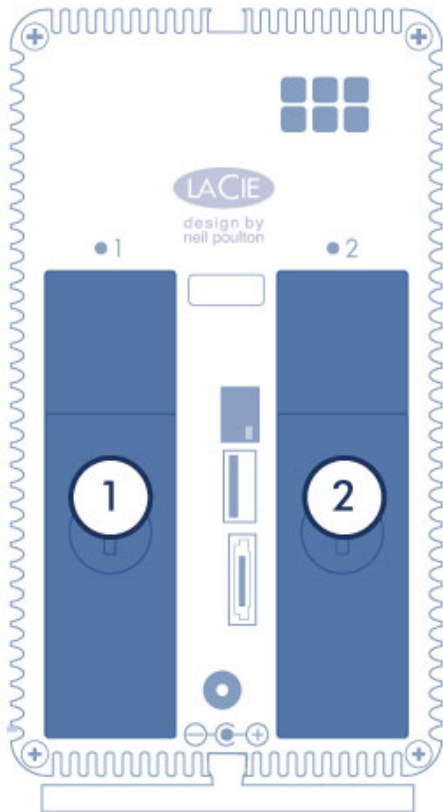

**Caution:** After continuous use of the LaCie NAS, the hard drives may be hot. Use caution when removing a hard drive.

1. Use the included hard disk drawer key to turn the lock until the slot is vertical.

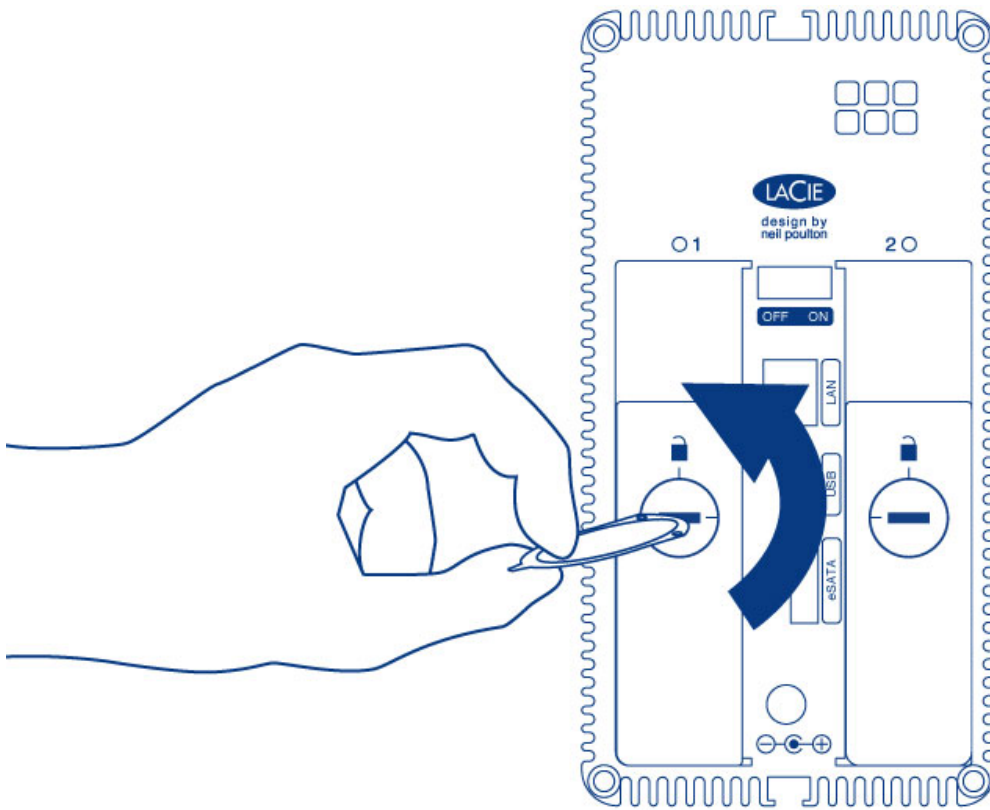

2. Draw out the hard drive tray by inserting your finger into the space behind the hard drive tray handle and pulling to disengage the hard drive.

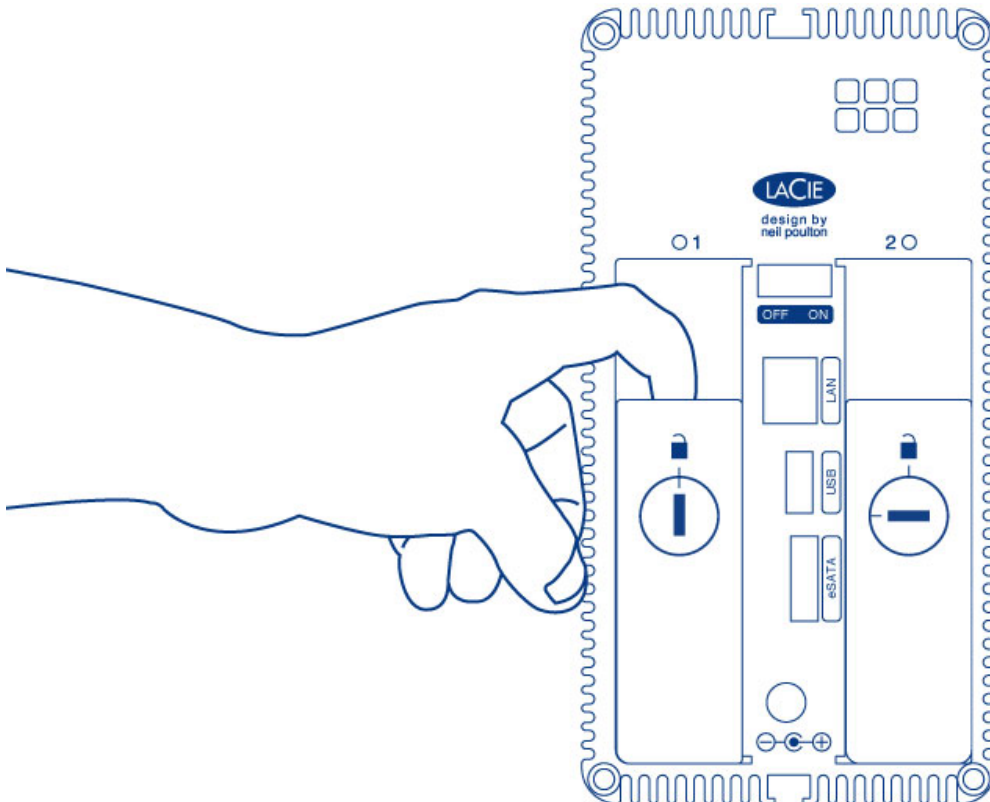

3. Grasp the hard drive tray handle and carefully extract the hard drive.

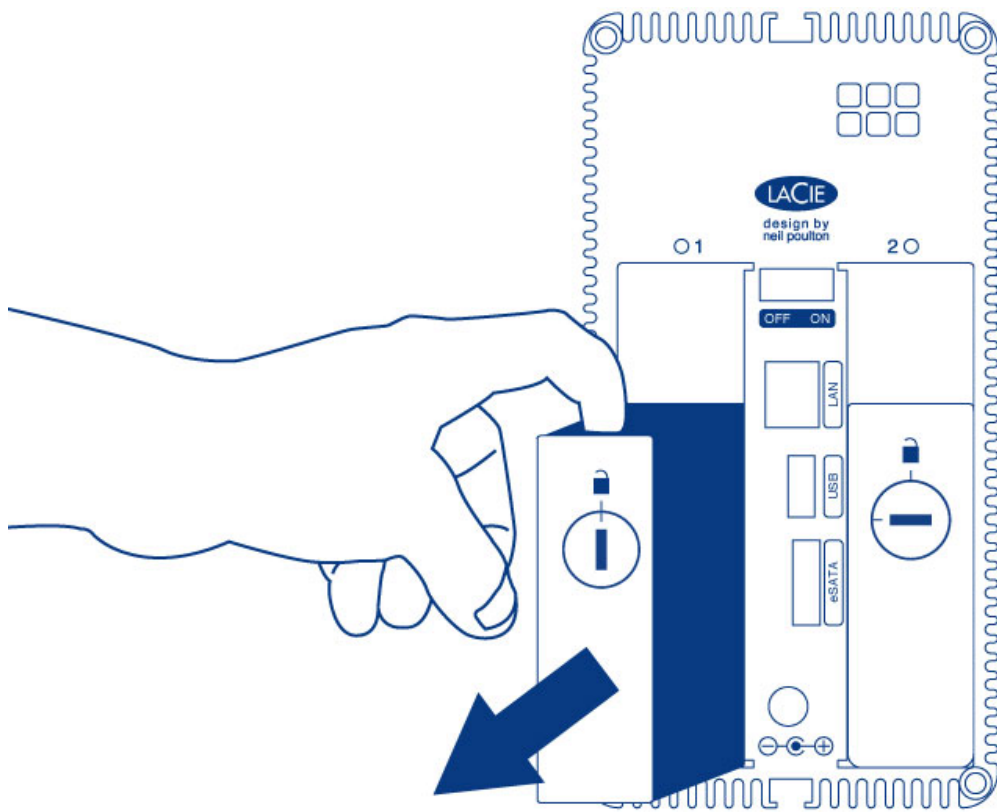

## Disk Insertion

For instructions on fixing a hard drive to the disk tray, go to [Connect to the Network: Diskless LaCie 2big NAS](#).

1. Carefully insert the tray into an empty hard drive bay. When the tray is most of the way in and you feel resistance, press the handle firmly until you feel it snap into place and the handle is flush with the back of the LaCie NAS.
2. Use the disk drawer key to lock the hard drive.

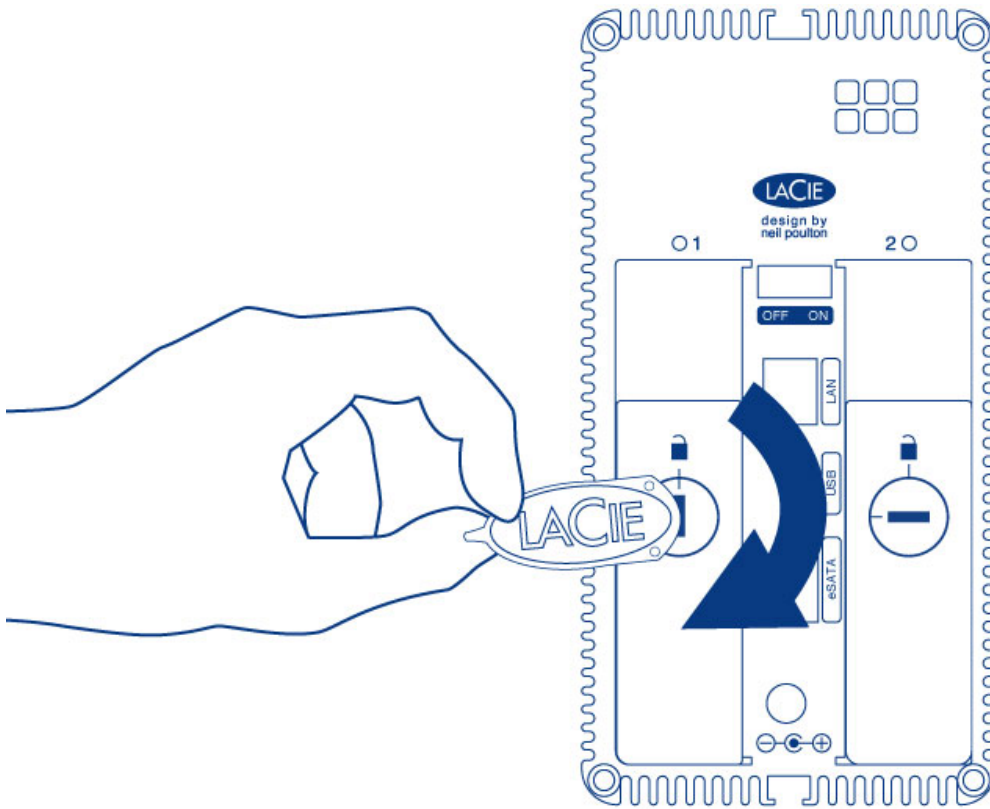

# 5BIG NAS PRO: ABOUT RAID MODES

Refer to the table below for an overview of the RAID modes available to the LaCie 5big NAS Pro. Note that the levels of performance and protection will differ based upon the number of drives in the volume. The *New storage volume* wizard includes a helpful tooltip with star ratings for performance and protection based upon the amount of disks in the volume.

RAID Mode	Minimum Hard Drives
SimplyRAID	1 (no data protection) or 2 (with data protection)
JBOD	1
RAID 0	2
RAID 1	1 (no data protection) or 2 (with data protection)
RAID 5	3
RAID 6	4

The factory default RAID for an enclosure purchased with five hard drives is SimplyRAID with single-disk protection.

**Note on enclosures with one hard drive:** You can create a SimplyRAID or a RAID 1 volume with a single drive in the enclosure. Single-disk volumes can be expanded by adding new disks to the enclosure and following the instructions at [Hard Disk Expansion: Single-Disk and Unprotected Volumes](#). Data will remain intact on the volume during expansion. Additionally, expanding RAID 1 and SimplyRAID will provide protection against the loss of a single hard drive. However, there is NO DATA PROTECTION when the volume has only one hard drive.

**Important info on NAS backup:** It is recommended that all users back up data to DAS or another NAS as further protection against disk failure or secondary points of failure (e.g. hardware, network, etc.). See [Backup Jobs](#) for details.

## GET HELP CHOOSING YOUR RAID

Understanding RAID and its many levels is critical when deciding how best to apportion the disks in your NAS. To help administrators configure their RAID volumes, LaCie NAS OS provides a handy star rating system with an intuitive storage capacity bar.

The last step of the *New storage volume* wizard provides:

- A list of available RAID configurations that are compatible with the amount of disks in the volume
- A tooltip that rates each level of RAID for the volume

**Note:** Step-by-step instructions on how to use the New storage volume wizard are available in [New Storage Volume Wizard](#).

## Available RAID configurations

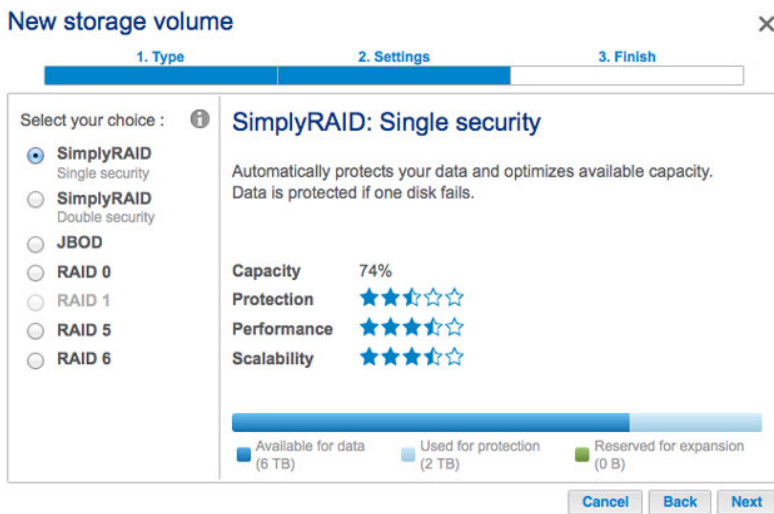

The screenshots in this section represent levels of RAID available to an enclosure with:

- Three 2TB disks
- Two 1TB disks

All levels of RAID can be selected except for RAID 1, which is not compatible with volumes greater than three disks. Choose a RAID's radio button next to review its strengths and weaknesses in the center of the window. See the three examples below:

### ▪ RAID 0

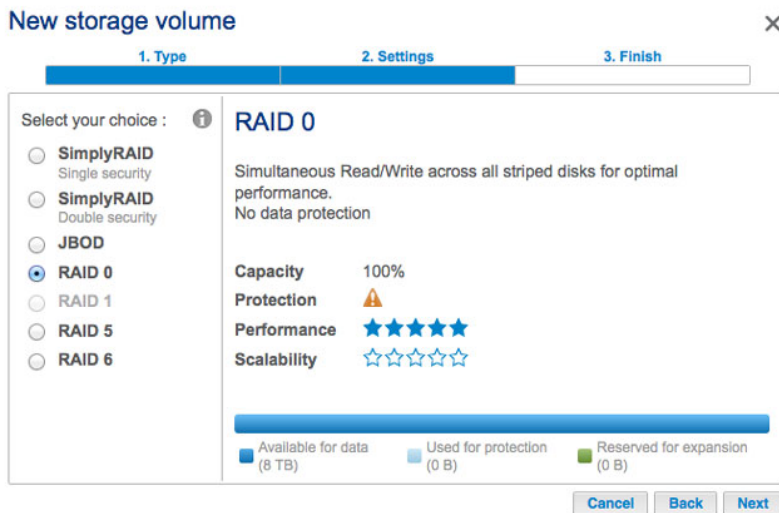

### ▪ RAID 6



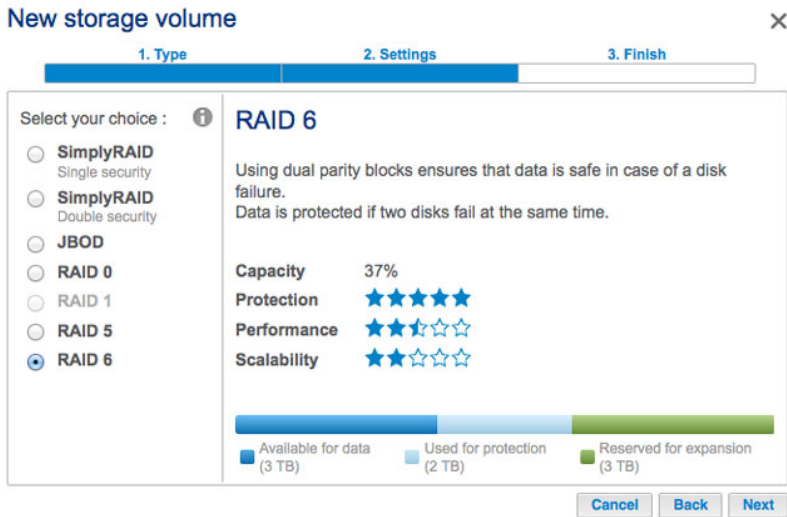

▪ **SimplyRAID Double security**

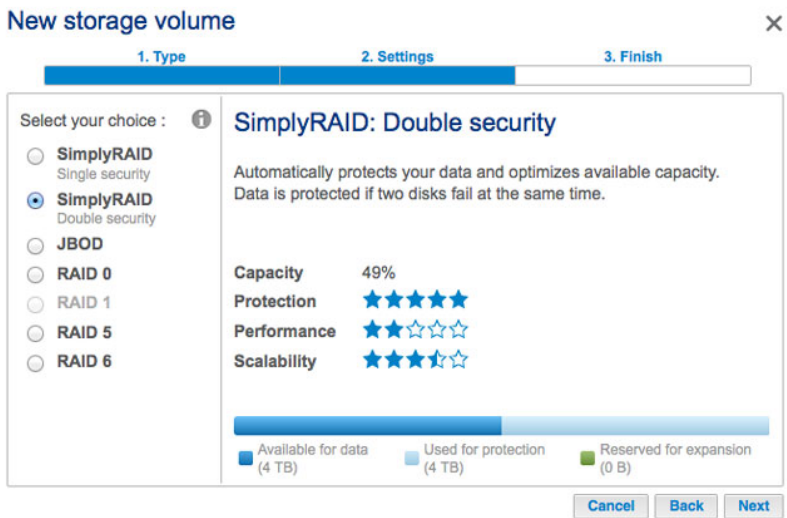

As the screenshots above show, RAID 0 is the best choice for storage capacity but it has a major weakness, no data protection. Both RAID 6 and SimplyRAID Double security offer data protection even if two disks fail. However, SimplyRAID optimizes storage capacity far better than RAID 6, giving users more space to store files.

## Tooltip comparison

There is an easy way to compare all levels of RAID in one table, the tooltip. Click on the **i** next to **Select your choice**.

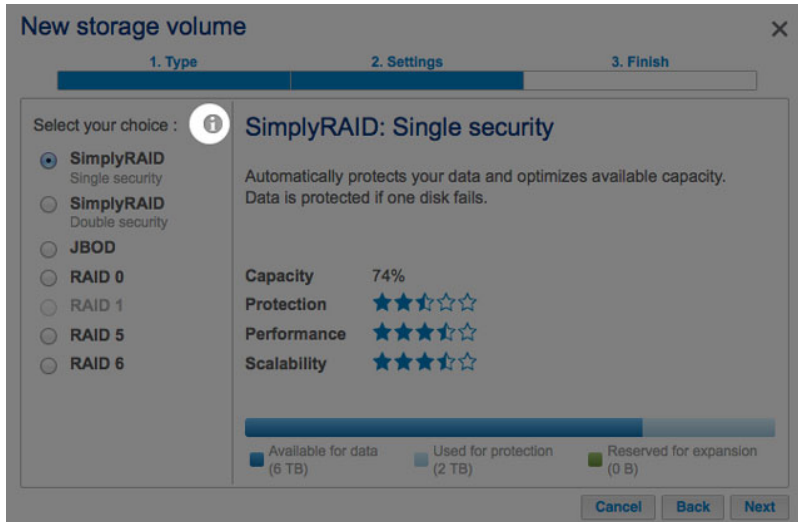

A table will appear comparing all levels of RAID via star ratings and the storage capacity bar.

**RAID options with selected disks**

RAID mode	Performance	Protection	Scalability	Capacity
SimplyRAID - Single security	★★★★☆	★★★★☆	★★★★☆	
SimplyRAID - Double security	★★★★☆	★★★★★	★★★★☆	
JBOD	☆☆☆☆☆	⚠	★★★★★	
RAID 0	★★★★★	⚠	☆☆☆☆☆	
RAID 5	★★★★☆	★★★☆☆	★★★★☆	
RAID 6	★★★☆☆	★★★★★	★★★★☆	

■ Available for data (6 TB)
 ■ Used for protection (2 TB)
 ■ Reserved for expansion (0 B)

## 5BIG NAS PRO: RAID OPTIONS

Choose the level of RAID to learn how it works with your NAS.

### LaCie SimplyRAID

Most RAID modes use equal disk capacities among the pool of hard drives to protect data. Rather than lose storage capacity overhead in mixed disk environments, SimplyRAID preserves the extra space for use when new disks are added to the enclosure. This means that, unlike standard RAID models, you can easily expand the array without losing data. For example, two 1TB disks will create a RAID 1 array without any disk capacity overhead. However, one 1TB disk paired with one 2TB disk can only create 1TB of protection since data cannot surpass the storage capacity of the smallest disk. SimplyRAID will calculate the overhead and prepare it for future disk expansion.

## JBOD (Just a Bunch of Disks)

Disks in a JBOD configuration store data sequentially. For example, data is written to Disk 1 first. Once Disk 1 is full, data will be written to Disk 2, then Disk 3, etc. Two advantages to this level of RAID are the availability of 100% of the disks' total storage capacity and easy expansion. However, all data will be lost if a single disk fails.

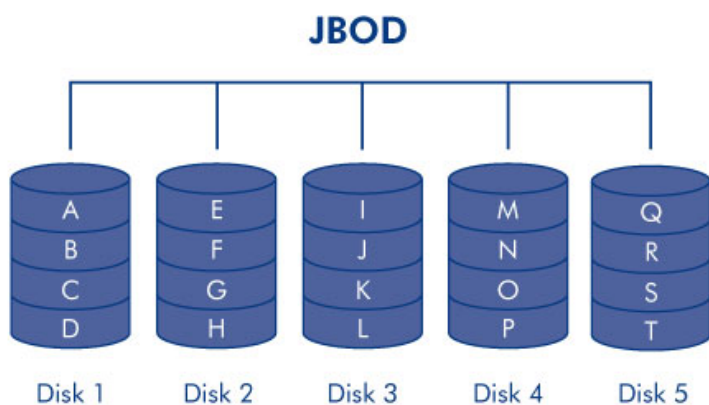

## RAID 0

RAID 0 is the fastest RAID mode since it writes data across all of the volume's disks. Further, the capacities of each disk are added together for optimal data storage. However, RAID 0 lacks a very important feature for a NAS: data protection. If one disk fails, all data becomes inaccessible. When weighing performance against protection, keep in mind that a NAS's transfer rates are contingent upon the bandwidth of the network as well as its own hardware. For example, with both LAN ports bonded and connected to a router that supports port aggregation, the 5big NAS Pro cannot exceed 200MB/s. A recommended option is RAID 5, which offers comparable performance, approximately 75% storage capacity (based upon total available disks and storage capacities), and data protection.

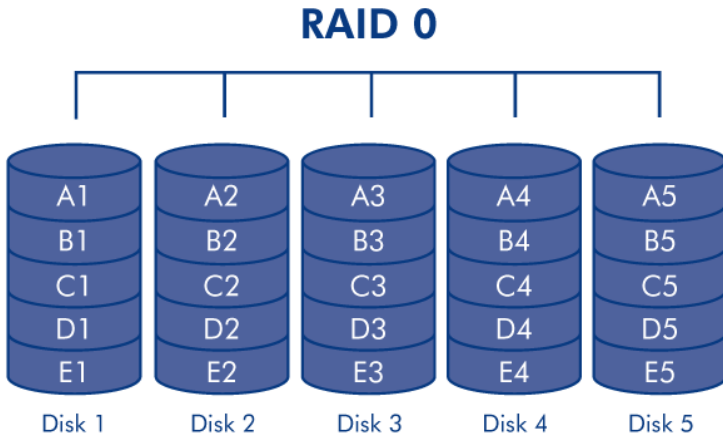

## RAID 1

RAID 1 provides enhanced data security since all data is written to each disk in the volume. If a single disk fails, data remains available on the other disk in the volume. However, due to the time it takes to write data multiple times, performance is reduced. Additionally, RAID 1 will cut disk capacity by 50% or more since each bit of data is stored on all disks in the volume.

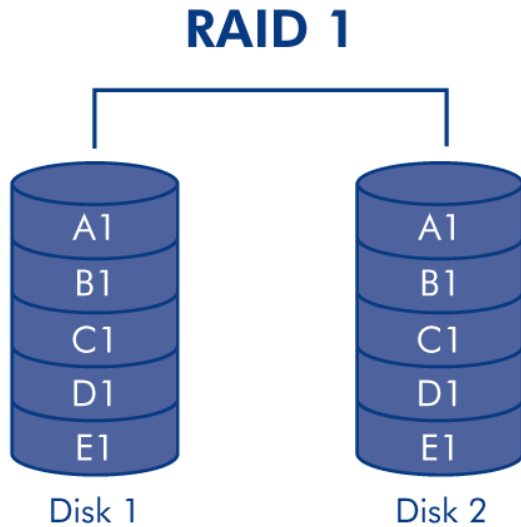

**Note on RAID 1 disk requirements:** A standard RAID 1 configuration includes two disks of equal capacity. However, NAS OS allows you to create a RAID 1 volume with up to three disks or, three disks plus a spare. It is also possible to create a RAID 1 volume using a single disk. While such a volume cannot provide any data protection, it is ready for expansion when you add a new disk. Data protection would become available once the second disk is added to the RAID 1 volume.

## RAID 5

RAID 5 writes data across all disks and a parity block for each data block is written on the same stripe (**p** in the illustration below). A minimum of three disks is required to create a RAID 5 volume. If one physical disk fails, the data from the failed disk can be rebuilt onto a replacement disk. No data is lost in the case of a single disk failure, but if a second disk fails before data can be rebuilt to the replacement hard drive, all data in the array will be lost.

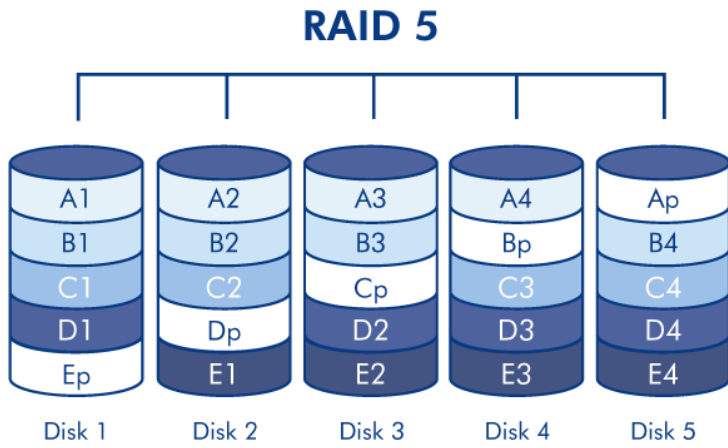

## RAID 6

RAID 6 writes data across all disks and two parity blocks for each data block are written on the same stripe (**p** and **q** in the illustration below). A minimum of four disks is required to create a RAID 6 volume. If one physical disk fails, the data from the failed disk can be rebuilt onto a replacement disk. This RAID mode can support up to two disk failures with no data loss. RAID 6 synchronizing from a failed disk is slower than RAID 5 due to the use of double parity. However, it is far less critical due to double-disk security.

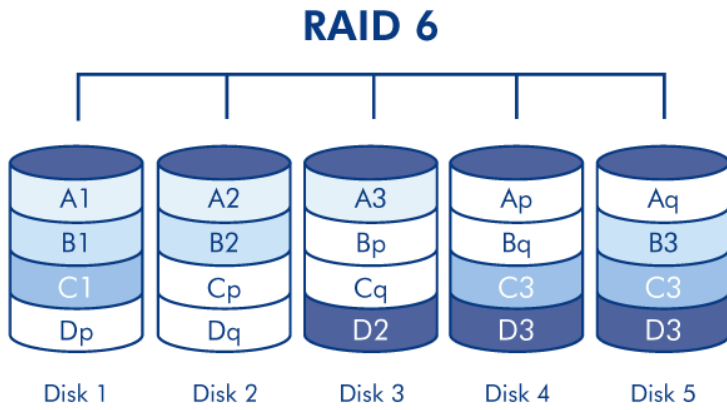



RAID Mode	Maximum Spare Drives
RAID 1	3
RAID 5	2
RAID 6	1

In a RAID 1 configuration, the same data is written across all hard disks in the volume, protecting your data against the loss of one disk. With RAID 5 and RAID 6, data is available from the parity blocks and protected should one or two drives fail, respectively. A RAID+Spare volume gives you a “hot-spare” that is ready to synchronize data immediately should a disk fail. If a hard disk in the volume fails, the data starts to synchronize with the spare. The clear advantage for a RAID volume with a spare is that you do not have to wait for a replacement disk.

When the failed disk is replaced, the replacement disk becomes the new hot spare.

To create a volume with a spare hard drive, you must choose **Custom** in the *New volume wizard*. Selecting **Quick setup** in the *New volume wizard* will automatically configure a volume with LaCie SimplyRAID and single disk protection. SimplyRAID optimizes disk space across all hard drives to maximize data storage. Therefore, it does not include the option to add a spare drive. See [New Storage Volume Wizard](#) for instructions on creating volumes with the *New volume wizard*.

### RAID 5+Spare

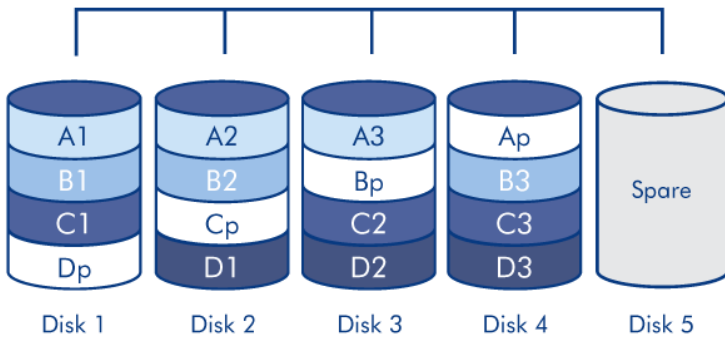

**Important info:** For RAID+Spare volumes, data remains intact when a single disk fails and the spare begins synchronizing automatically. If a second disk in the volume fails before synchronization is complete, all data in the volume will be lost.

# NEW STORAGE VOLUME WIZARD

Build one or more volumes using the *New storage volume wizard*. You can select:

- **Quick setup:** Skip multiple configuration steps with LaCie SimplyRAID, LaCie's smart RAID configuration agent. SimplyRAID will review the amount of disks in the enclosure and the total storage to optimize data capacity and protect your data. To provide the most disk space for your data, *Quick setup* configures a SimplyRAID volume with single-disk security. Use Custom for SimplyRAID with double-disk security.
- **Custom:** Configure a volume using LaCie SimplyRAID or standard RAID models. *Custom* offers a wide range of RAID configurations:
  - SimplyRAID with double-disk security (minimum of four disks)
  - JBOD
  - RAID 0 (two disks minimum)
  - RAID 1 (two disks minimum for data protection)
  - RAID 1+Spare (three disks minimum). Additional steps required to add the spare.
  - RAID 5 (three disks minimum)
  - RAID 5+Spare (four disks minimum) Additional steps required to add the spare.
  - RAID 6 (four disks minimum)
  - RAID 6+Spare (five disks minimum). Additional steps required to add the spare.

**SimplyRAID and spare disks:** Since LaCie SimplyRAID optimizes storage capacity using all disks in a volume, it is not possible to add a spare disk to a SimplyRAID volume.

**Important note on SimplyRAID with double-disk security:**

- You must use **Custom** to configure five disks as SimplyRAID with double-disk security.
- The *New storage volume wizard* does not offer a migration path from SimplyRAID single-disk security to SimplyRAID double-disk security.

**Important info on creating a single-disk volume:** Single-disk volumes can be created with expansion in mind. For example, you can launch the *New storage volume wizard* to create a single-disk volume using SimplyRAID, JBOD, or RAID 1. Though the volume will not provide data protection in a single-disk configuration, it is prepared for expansion when you add one or more disks to the enclosure. If you intend to expand the volume to four or more disks, it is recommended that you create the volume using SimplyRAID since RAID 1 cannot reach beyond three disks.

**Important info:** Backing up data stored on your LaCie NAS to desktop storage and/or another NAS will help keep critical files safe from hard drive or hardware failure. This is especially true for volumes that are not configured for RAID protection. Therefore, it is highly recommended that you perform frequent backups. See [Backup Jobs](#) for detailed instructions on how to back up your LaCie NAS.

## NEW STORAGE VOLUME WIZARD STEPS

The default names for newly created volumes are *Volume 1*, *Volume 2*, etc. For instructions on how to change the name of the volume, see [Volume Tools](#).

Quick setup

Insert disks into the enclosure before following the directions below. For instructions, see [Remove/Insert a Hard Disk](#) or [Connect to the Network: Diskless LaCie 5big NAS Pro](#).

1. Select the new disk(s) on the top of the left-hand column.

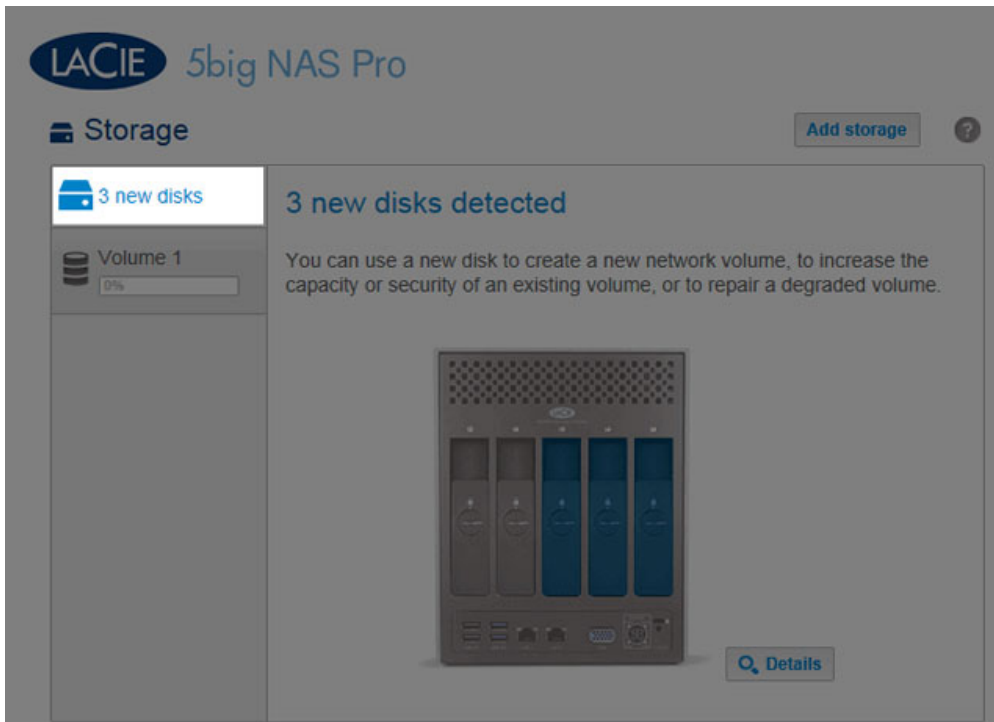

2. Choose the **Add storage** button to launch the *New storage volume* wizard.

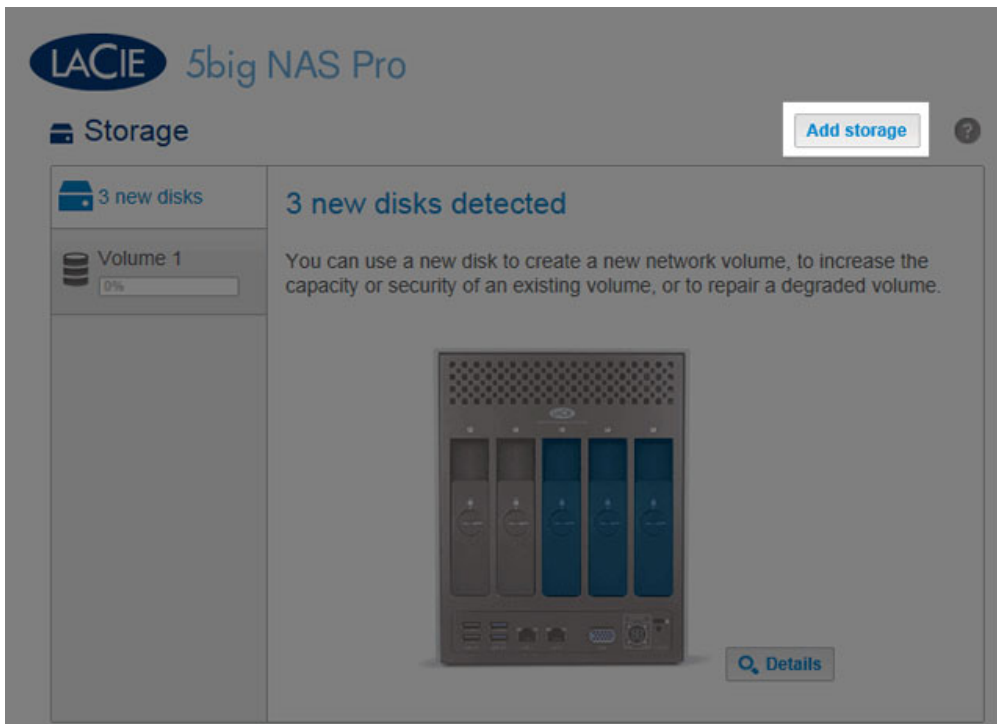

3. Select **Network volume**, then choose **Next**.

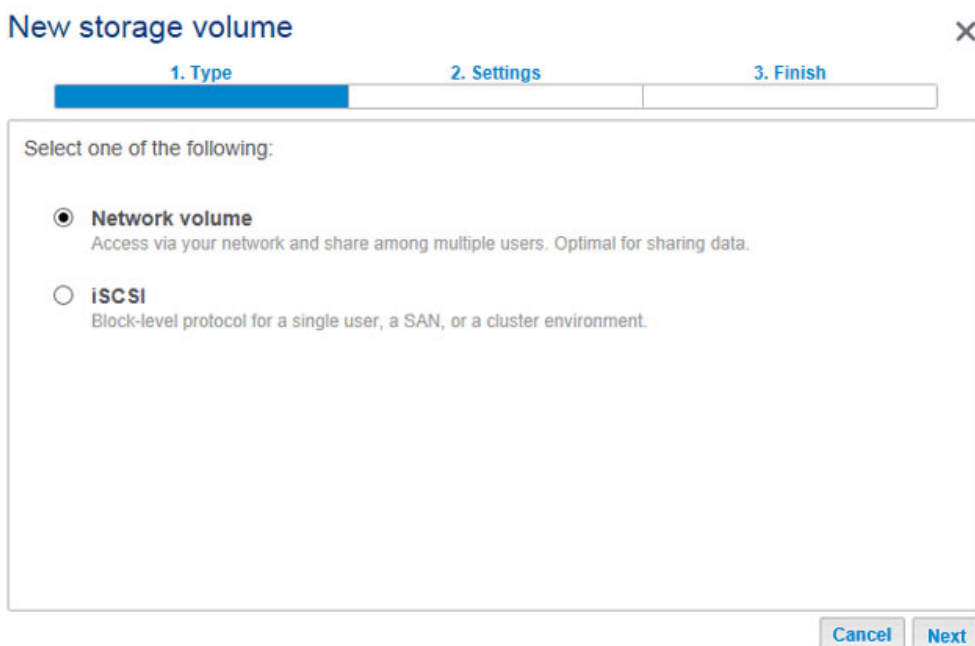

4. The *Select disks* window lists all the disks in the enclosure. Grey disks are being used by one or more existing volumes and cannot be selected. White disks are available for the new volume. Select the box under each disk that you want to use for the new volume then choose **Next**. All data on the disks will be deleted to create the RAID configuration.

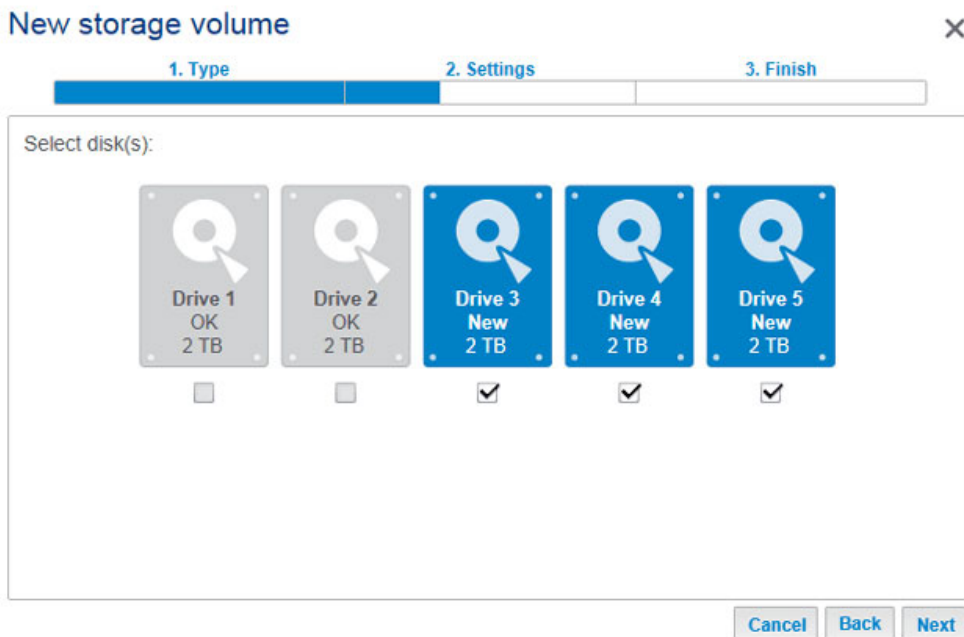
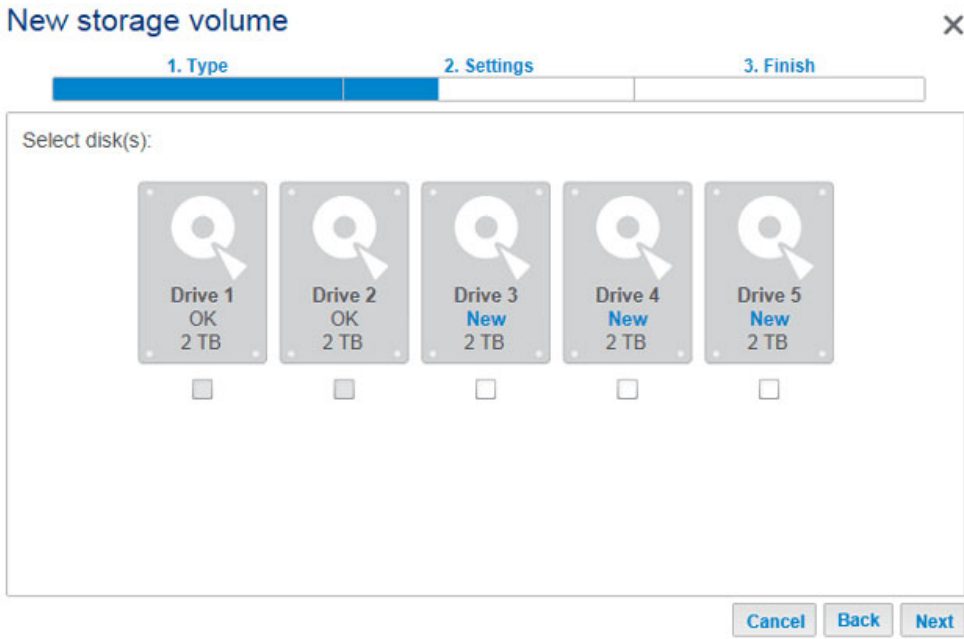

5. Select **Quick setup** to create a SimplyRAID volume to optimize your storage for data and protection. With two or more disks, SimplyRAID will create a RAID volume using single-disk security. If you choose *Custom*, refer to the instructions below. Choose **Next** to continue.



- Review the summary window then choose **Finish**. A popup window cautions you that all data on the selected disks will be deleted to create the volume. Select **Yes** to build the SimplyRAID volume.

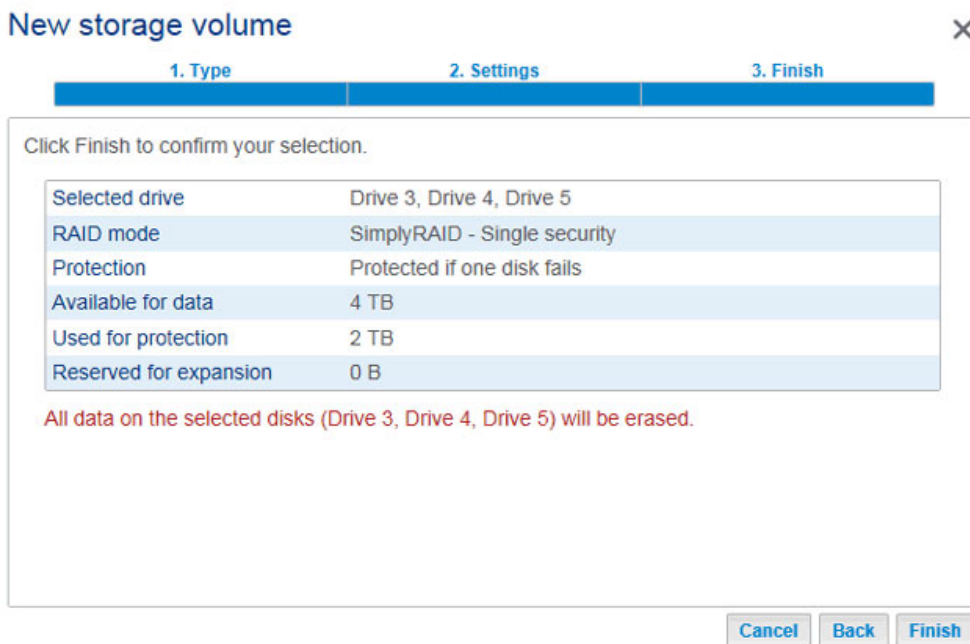

- The amount of time to synchronize the volume depends upon the total capacity of your disks. However, you can start using the volume immediately. See [Shares](#) for instructions on how to create new shares on the volume to store and share data.

Storage

Add storage



Volume 1  
0%

Volume 2  
0%

Volume 2

Manage Format Delete

Capacity 3.9 TB of 3.9 TB

Mode SimplyRAID

Status Synchronizing (0.1%)

Drives



Details



## Custom

Your options to select the level of RAID are predicated upon the number of disks in your array. For example, a three-disk configuration allows you to select from LaCie SimplyRAID, JBOD, RAID 0, RAID 1, or RAID 5. A four- or five-disk configuration offers LaCie SimplyRAID, JBOD, RAID 0, RAID 5, or RAID 6.

**Adding a spare:** If you intend to create a volume with a spare drive, you must leave at least one hard drive free. For example, a four-disk RAID 6 array with spare would require that you create the RAID 6 with the first four disks (from left to right) before moving to the next section to add the fifth hard disk as the spare.

Install disks into the enclosure before following the directions below. For instructions, see [Connect to the Network: Diskless LaCie 5big NAS Pro](#).

1. Select the new disks at the top of the left-hand column.

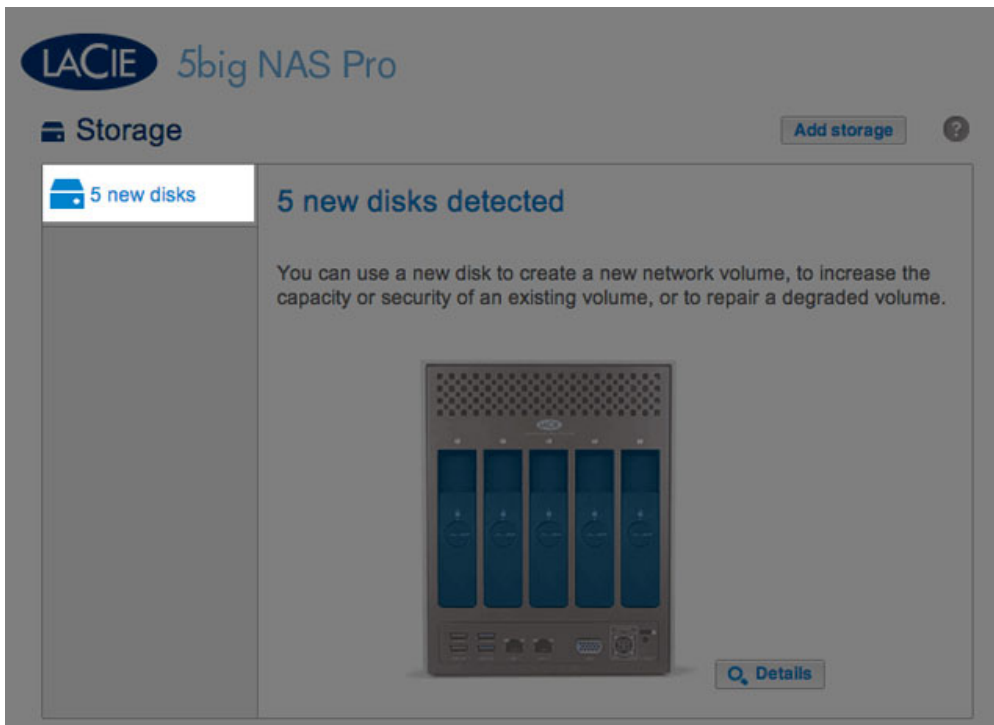

2. Choose the **Add storage** button to launch the *New storage volume* wizard.

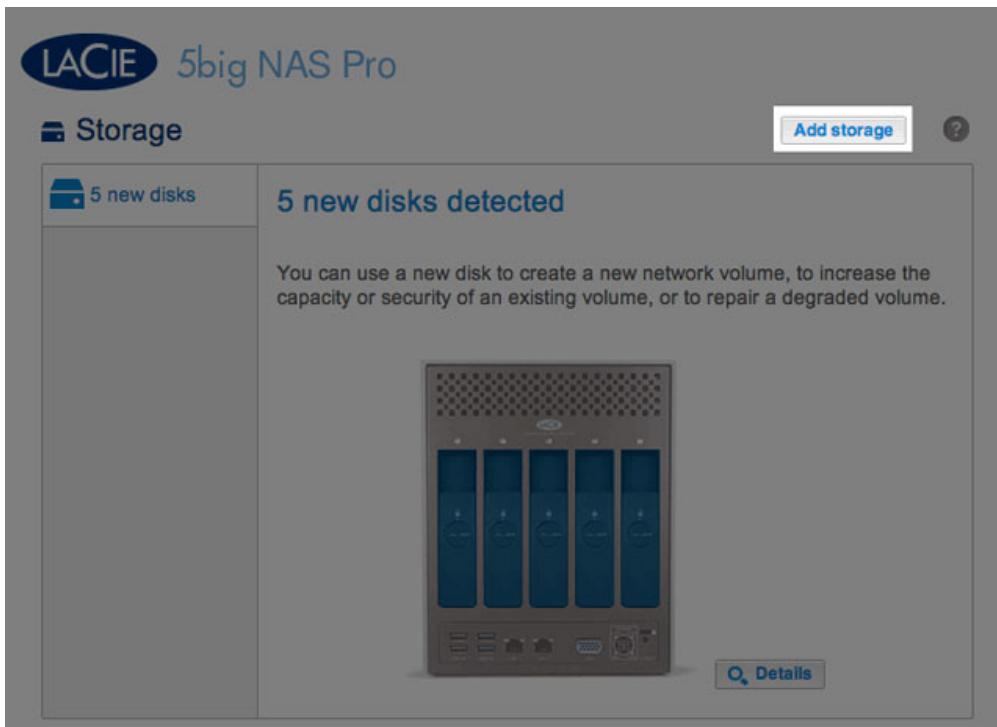

3. Select **Network volume**, then choose **Next**.

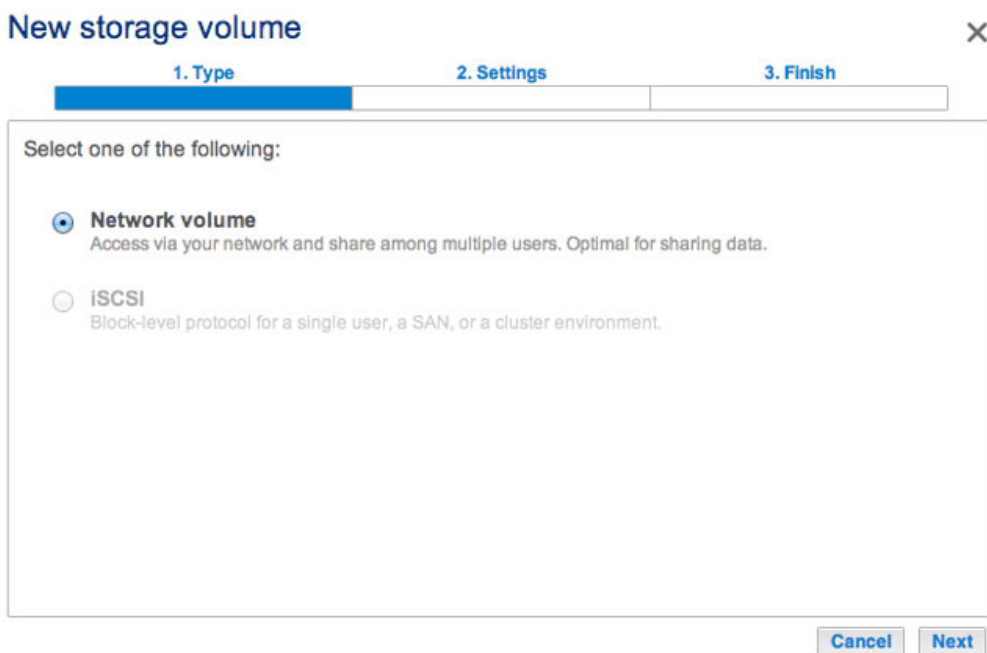

4. The *Select disks* window lists all the disks in the enclosure. Grey disks are being used by one or more existing volumes and cannot be selected. White disks are available for the new volume. Select the box under each disk that you want to use for the new volume then choose **Next**. All data on the disks will be deleted to create the RAID configuration.

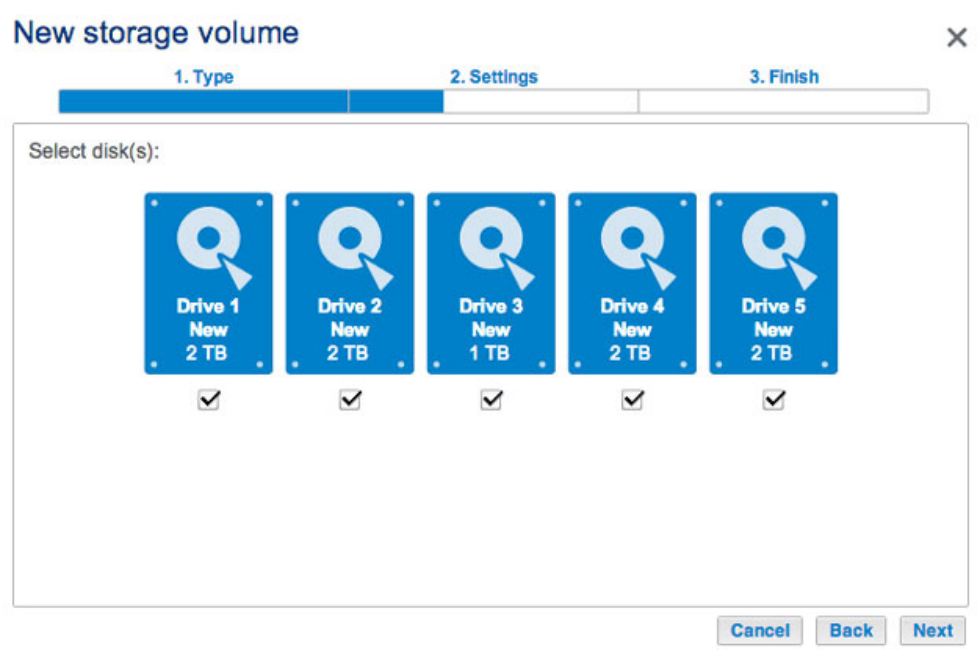
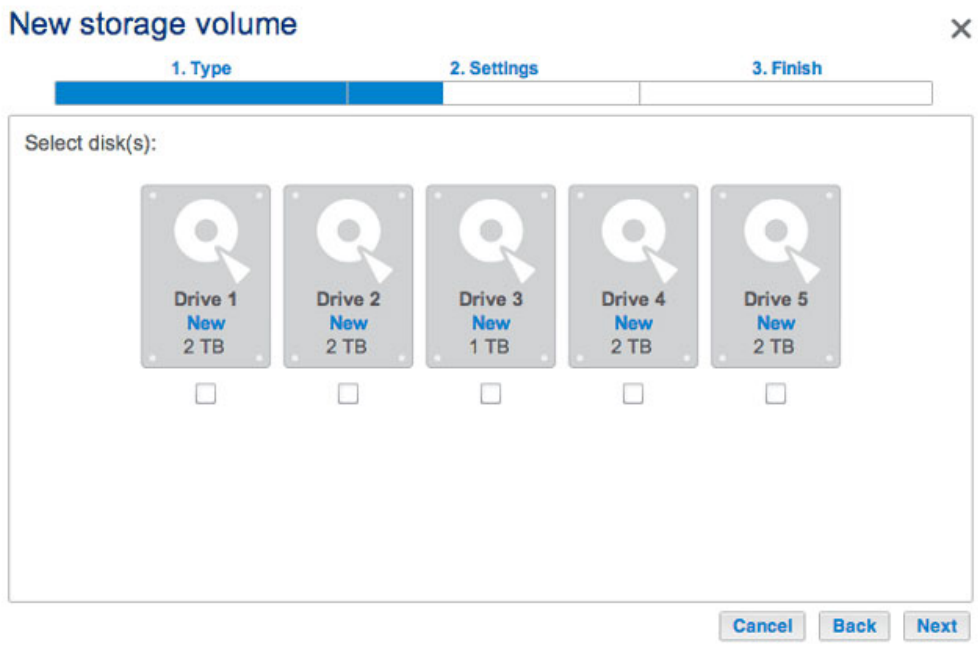

5. Select **Custom** then choose **Next**.



6. The RAID selection window helps you to select the optimal configuration for your environment:
- Select a RAID mode's radio button to view an explanation of its strengths and weaknesses.

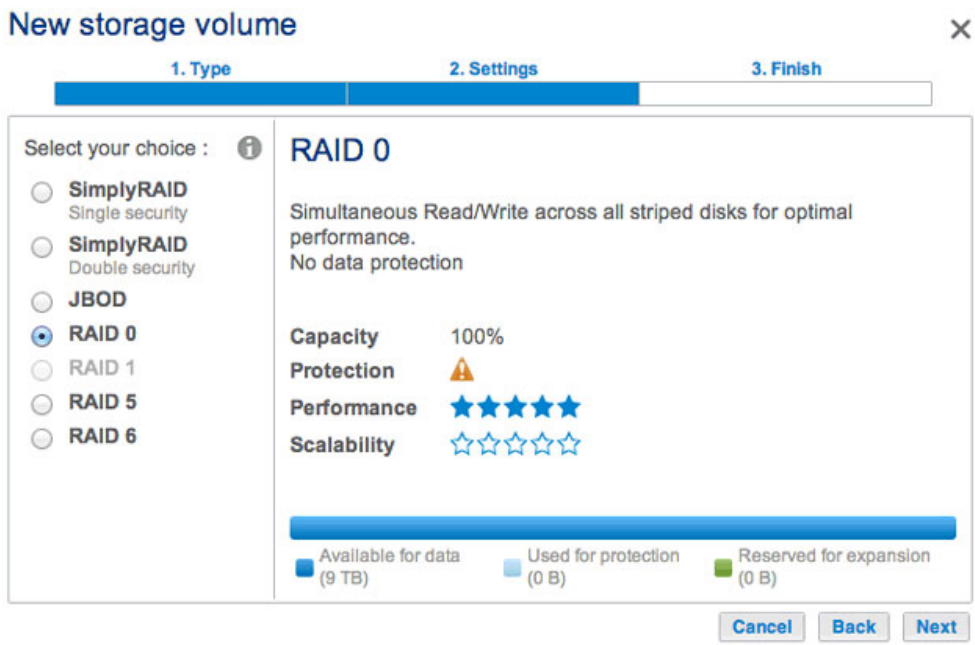

**SimplyRAID Double security**

## New storage volume



1. Type

2. Settings

3. Finish

Click Finish to confirm your selection.

Selected drive	Drive 1, Drive 2, Drive 3, Drive 4, Drive 5
RAID mode	RAID 0
Protection	No data protection
Available for data	9 TB
Used for protection	0 B
Reserved for expansion	0 B

All data on the selected disks (Drive 1, Drive 2, Drive 3, Drive 4, Drive 5) will be erased.

Cancel Back Finish

### RAID 0

## New storage volume



1. Type

2. Settings

3. Finish

Select your choice :

- SimplyRAID  
Single security
- SimplyRAID  
Double security
- JBOD
- RAID 0
- RAID 1
- RAID 5
- RAID 6

### RAID 5

Using parity blocks ensures that data is safe in case of a disk failure. Data is protected if one disk fails.

Capacity 44%  
Protection ★★★★★  
Performance ★★★★★  
Scalability ★★★★★



Cancel Back Next

### RAID 5

## New storage volume

1. Type      2. Settings      3. Finish

Select your choice :  **RAID 6**

- SimplyRAID  
Single security
- SimplyRAID  
Double security
- JBOD
- RAID 0
- RAID 1
- RAID 5
- RAID 6

Using dual parity blocks ensures that data is safe in case of a disk failure.  
Data is protected if two disks fail at the same time.

Capacity      33%

Protection      ★★★★★

Performance      ★★☆☆☆

Scalability      ★★☆☆☆

■ Available for data (3 TB)     
 ■ Used for protection (2 TB)     
 ■ Reserved for expansion (4 TB)

### RAID 6

- Use the cursor to choose the grey *i* tooltip to see a graphic summary of the strengths and weaknesses of each level of RAID.

### RAID options with selected disks

RAID mode	Performance	Protection	Scalability	Capacity
SimplyRAID - Single security	★★★★☆	★★★☆☆	★★★★☆	
SimplyRAID - Double security	★★★☆☆	★★★★★	★★★★☆	
JBOD	☆☆☆☆☆	⚠	★★★★★	
RAID 0	★★★★★	⚠	☆☆☆☆☆	
RAID 5	★★★★★	★★★★☆	★★★☆☆	
RAID 6	★★★☆☆	★★★★★	★★★☆☆	

■ Available for data     
 ■ Used for protection     
 ■ Reserved for expansion

7. Select the level of RAID that you want then choose **Next**. Note, if you are reconfiguring an existing RAID, the new mode will erase files on the shares but your Dashboard configuration will not be affected.
8. Review the summary window then choose **Finish**. A popup window cautions you that all data on the selected disks will be deleted to create the volume. Select **Yes** to build the volume.

## New storage volume



1. Type

2. Settings

3. Finish

Click Finish to confirm your selection.

Selected drive	Drive 1, Drive 2, Drive 3, Drive 4, Drive 5
RAID mode	RAID 0
Protection	No data protection
Available for data	9 TB
Used for protection	0 B
Reserved for expansion	0 B

All data on the selected disks (Drive 1, Drive 2, Drive 3, Drive 4, Drive 5) will be erased.

Cancel

Back

Finish

Custom+Spare

Before adding a spare hard drive, you must follow the instructions above (**Custom**) to create the RAID volume. When creating the volume, leave a minimum of one hard drive free for the spare. For example, a four-disk RAID 6 volume with spare would require that you create the RAID 6 with the first four disks (from left to right) before reviewing this section to add the fifth hard disk as the spare. You can follow the directions below with RAID 1, RAID 5, or RAID 6 volumes.

1. Insert the spare hard drive(s) into the LaCie 5big NAS Pro (see [Remove/Insert a Hard Disk](#) for instructions). The **Dashboard > Storage** should display at least one *New* hard drive.



2. Choose **Manage**.
3. Select **Add drive** and choose **Next**.

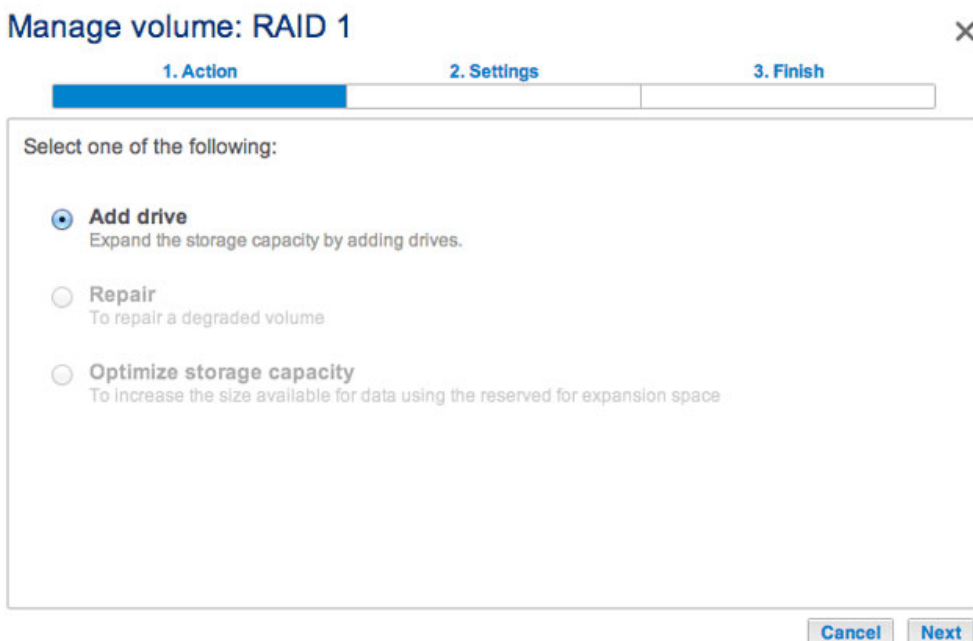



4. Check the box under the *New* hard drive(s) and choose **Next**.

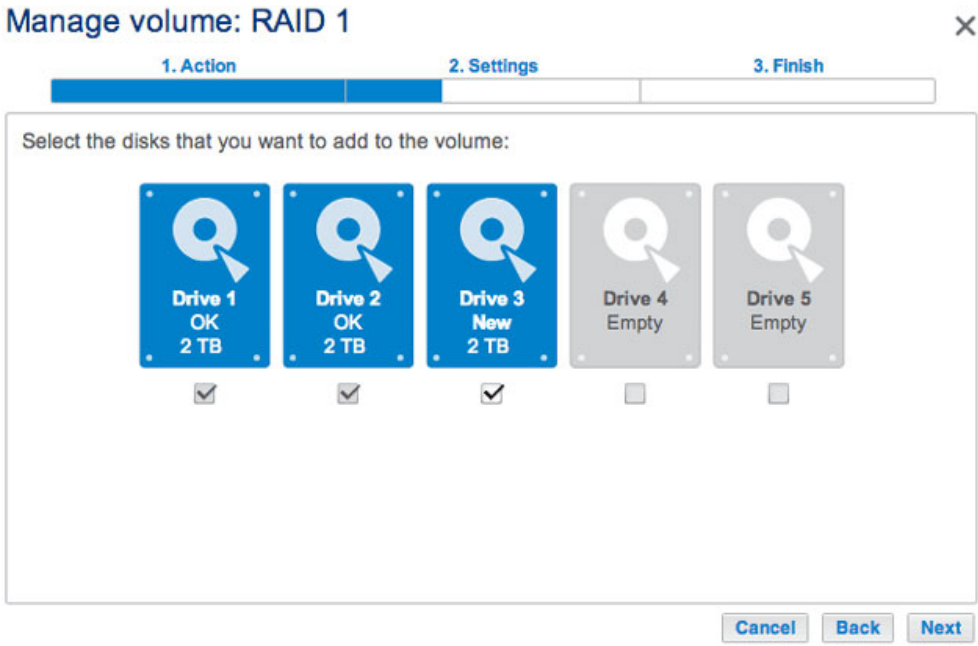

5. Select **Custom** and choose **Next**.

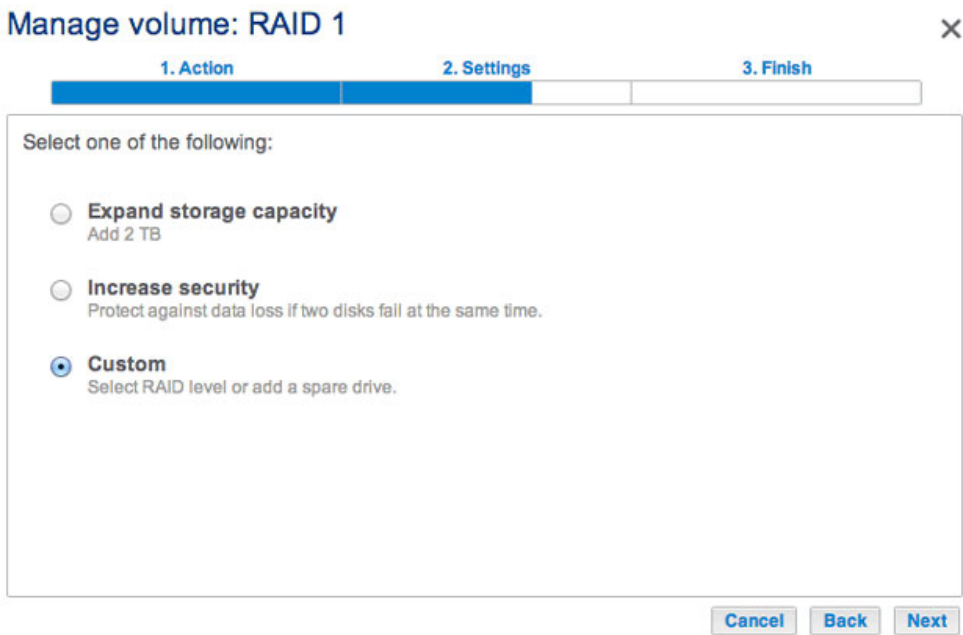

6. Select **Add spare drives** and choose **Next**.

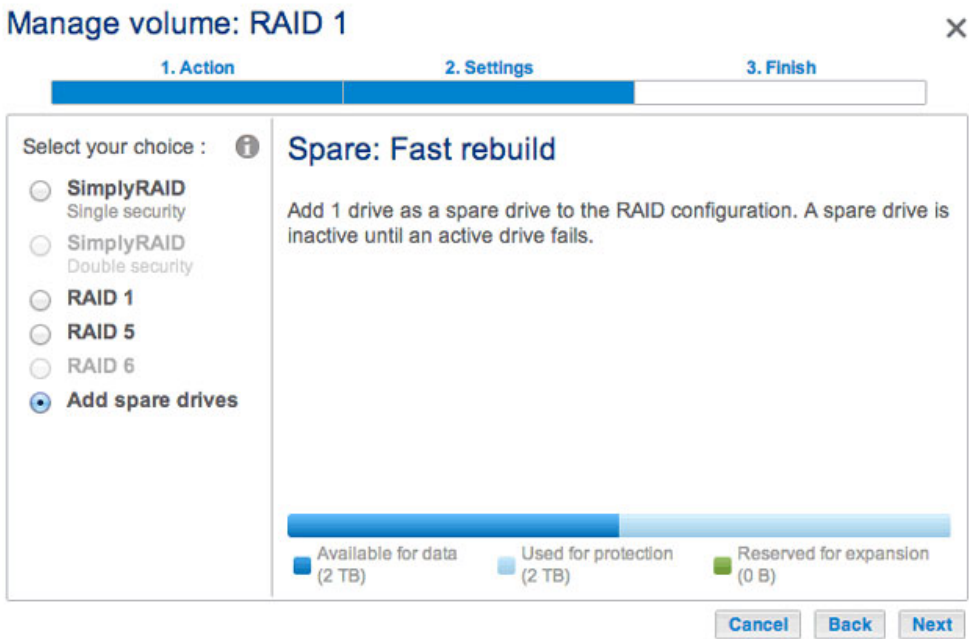

7. Review the summary and choose **Finish**. A popup window cautions you that all data on the selected disks will be deleted to create the volume. Select **Yes** to build the volume.

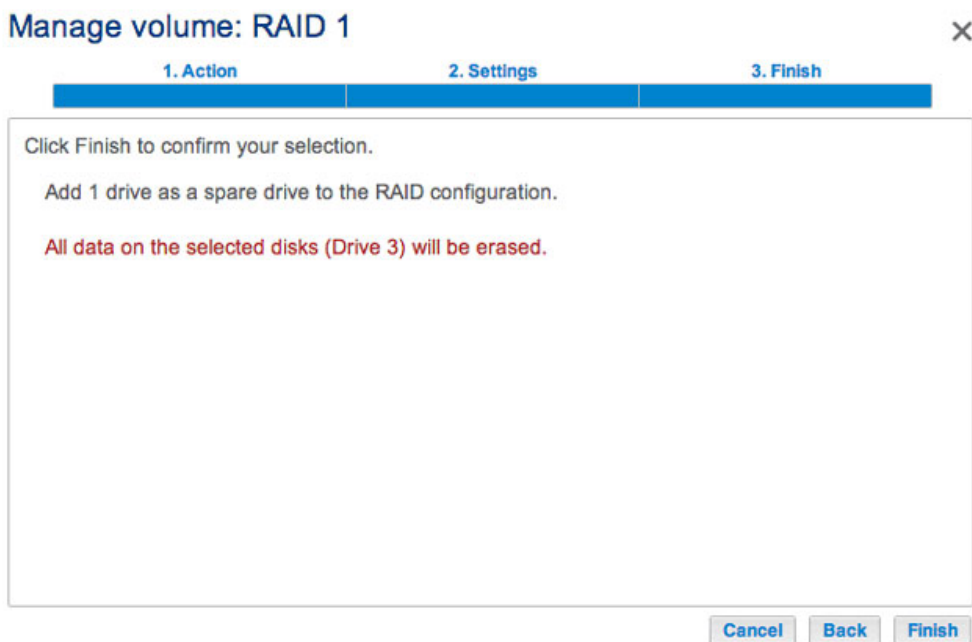

8. The *Spare* is now available.

RAID 1  
0%

RAID 1

Manage

Format

Delete

Capacity 2 TB of 2 TB

Mode RAID 1

Status OK

Drives

Drive details

X

Drive	Status	Capacity
1	OK	2 TB
2	OK	2 TB
3	Spare	2 TB



## Single-disk volume

NAS OS allows you to create a volume with only one disk, then expand as you add disks to the enclosure. A volume with a single disk can be configured for SimplyRAID, JBOD, or RAID 1. Each level of RAID has its own advantages, as described in [5big NAS Pro: About RAID Modes](#).

If you have not inserted the hard drive into the LaCie 5big NAS Pro, please see [Remove/Insert a Hard Disk](#) for basic instructions. For a full explanation of adding disks to the enclosure, see [Connect to the Network: Diskless LaCie 5big NAS Pro](#). Once the disk has been installed, the **Dashboard > Storage** page should display at least one new hard drive.

## SimplyRAID

1. Select **One new disk** at the top of the left-hand column, then choose **Add storage**.

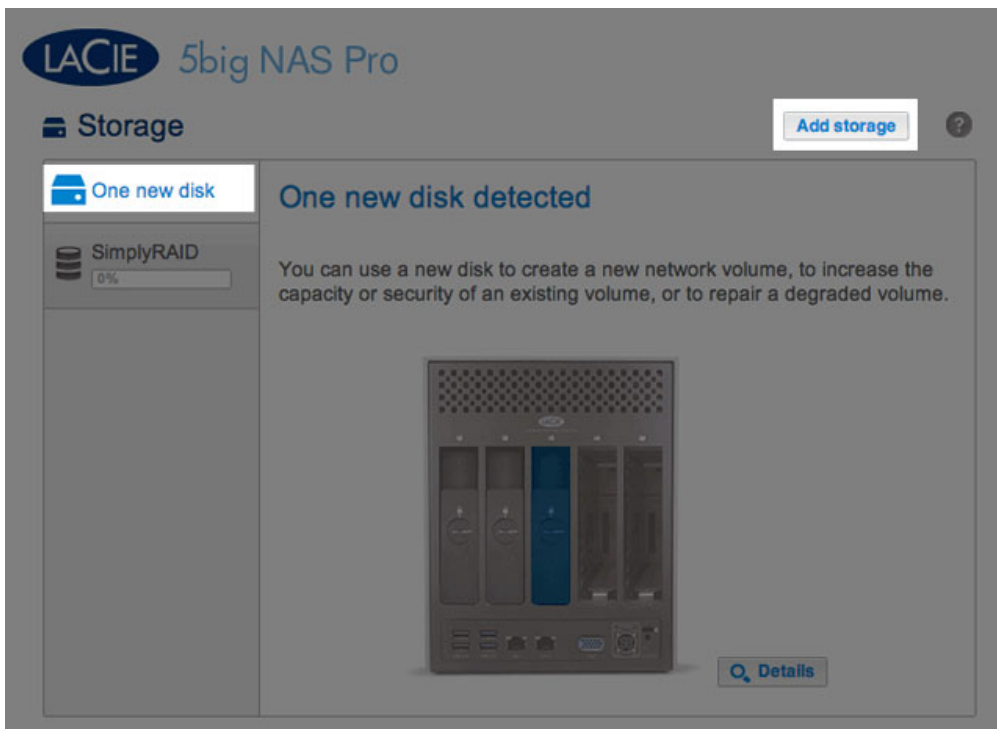

2. Select **Network volume** then choose **Next**.

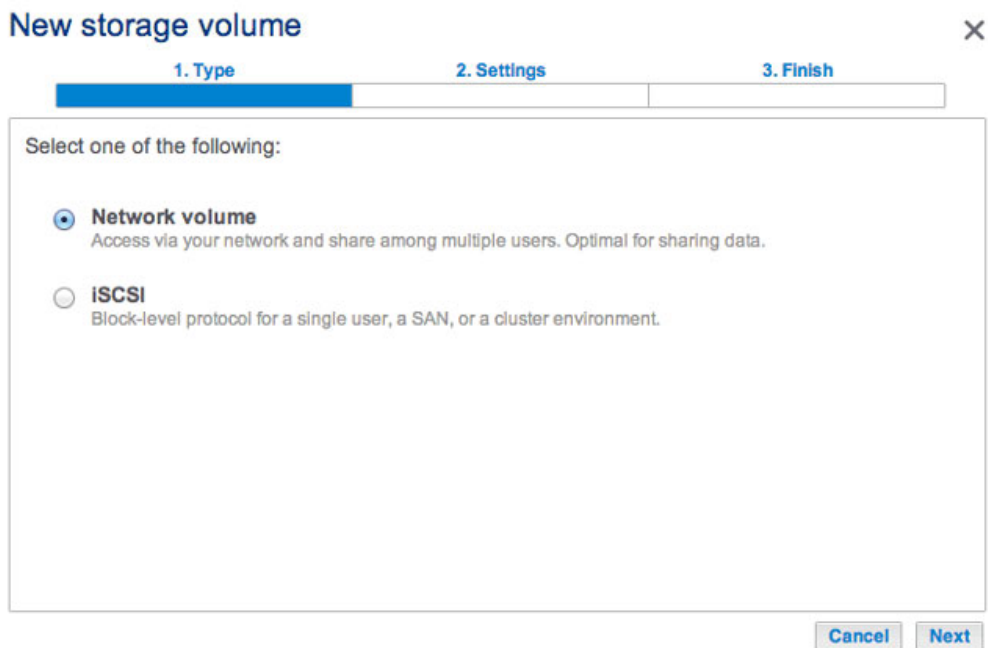

3. Select the check box under the new disk then choose **Next**.

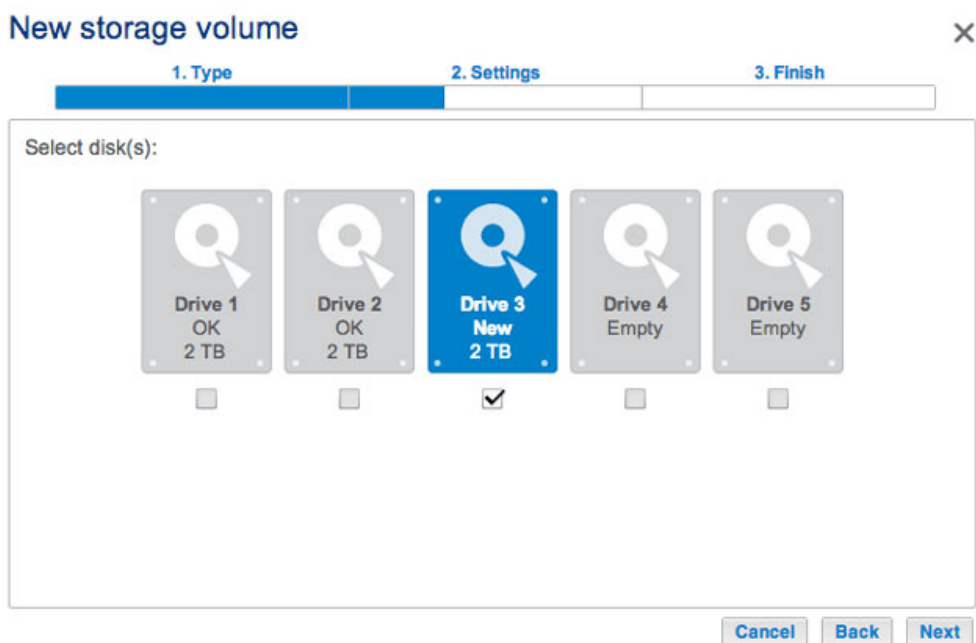

4. Select **Quick setup** then choose **Next**.

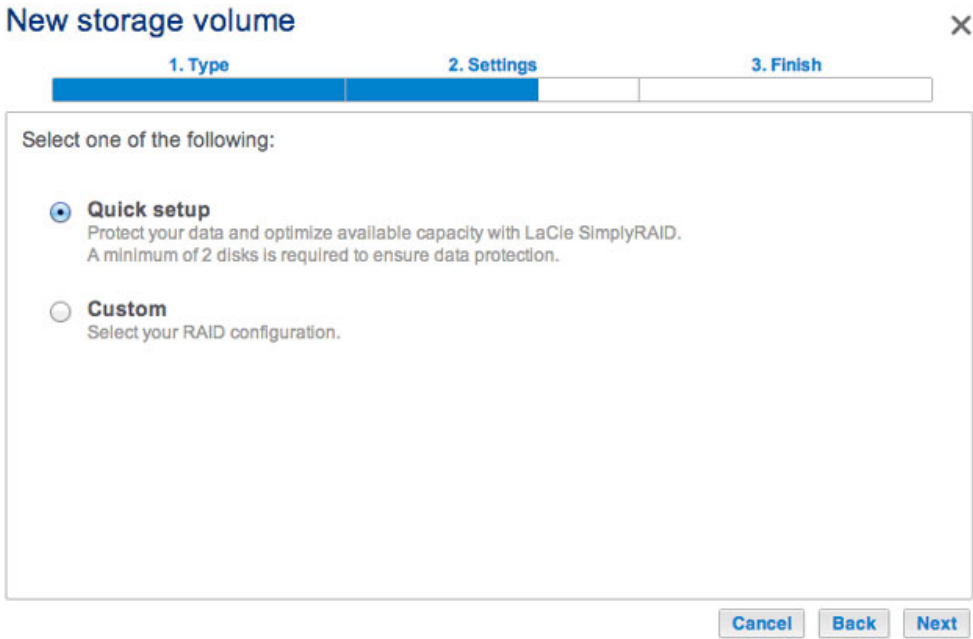

5. Review the summary window then choose **Finish**. A popup window cautions you that all data on the selected disks will be deleted to create the volume. Select **Yes** to build the SimplyRAID volume.

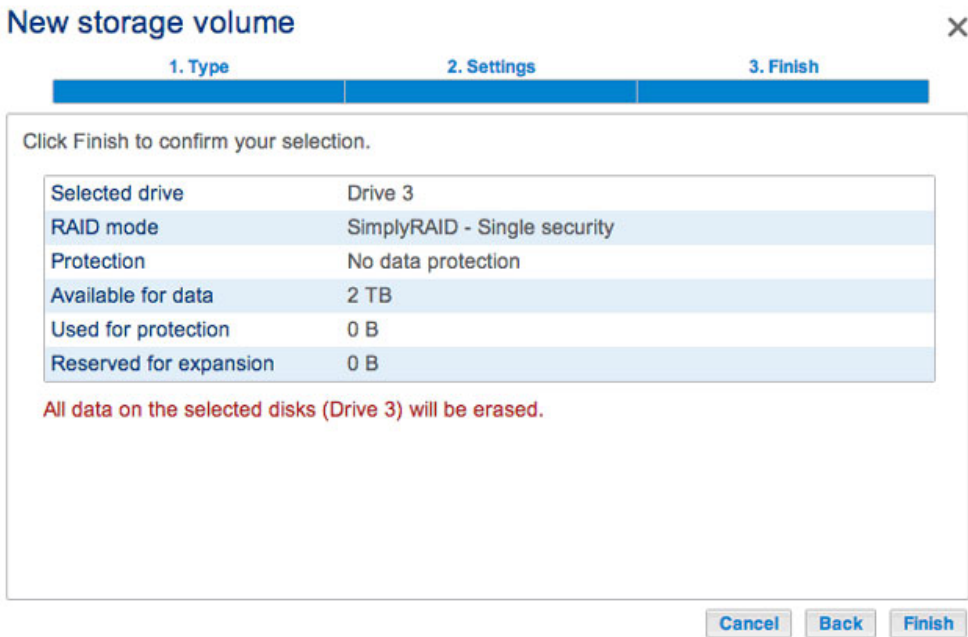

Though it is a SimplyRAID volume, data is not protected with a single disk.

### RAID 1 or JBOD

1. Select **One new disk** at the top of the left-hand column, then choose **Add storage**.

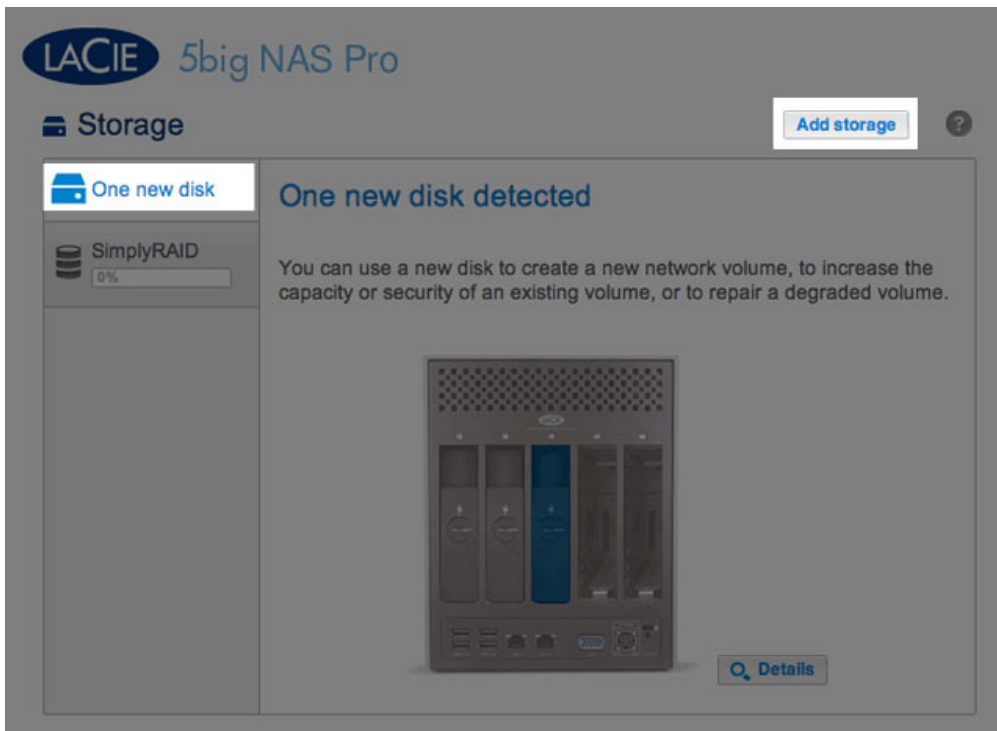

2. Select **Network volume** then choose **Next**.

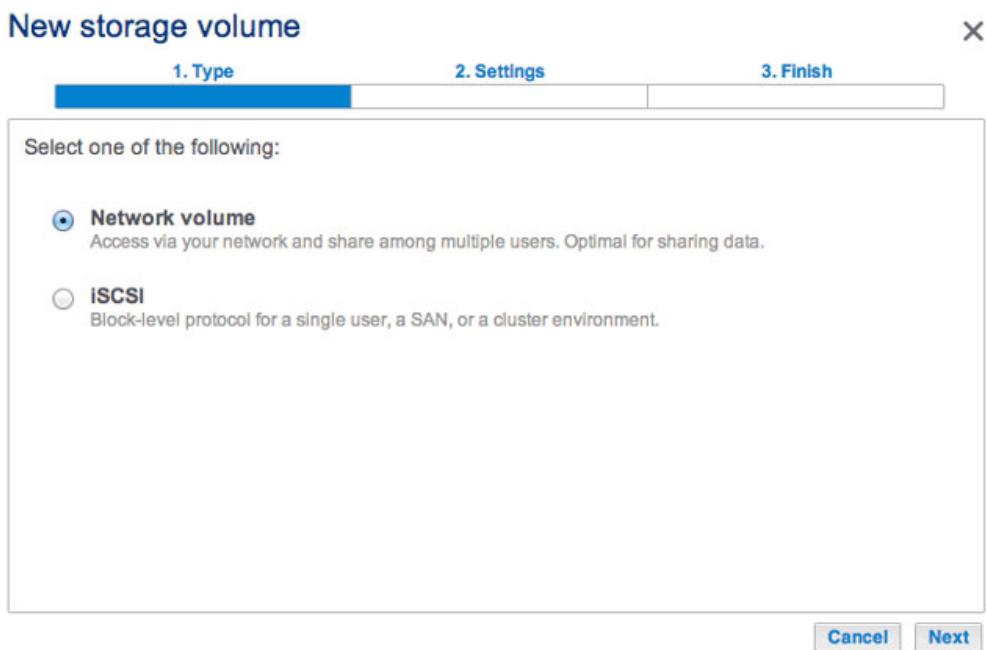

3. Select the check box under the new disk then choose **Next**.

## New storage volume



1. Type      2. Settings      3. Finish

Select disk(s):

 Drive 1 OK 2 TB	 Drive 2 OK 2 TB	 Drive 3 New 2 TB	 Drive 4 Empty	 Drive 5 Empty
<input type="checkbox"/>	<input type="checkbox"/>	<input checked="" type="checkbox"/>	<input type="checkbox"/>	<input type="checkbox"/>

4. Select **Custom** then choose **Next**.
5. Select JBOD or RAID 1, then choose **Next**.

## New storage volume



1. Type      2. Settings      3. Finish

Select your choice :

- SimplyRAID**  
Single security
- SimplyRAID**  
Double security
- JBOD**
- RAID 0
- RAID 1
- RAID 5
- RAID 6

**JBOD**

Writes data to a single disk until it is full and then continues on the next disk.  
No data protection

**Capacity**      100%

**Protection**

**Performance**

**Scalability**

Available for data (2 TB)       Used for protection (0 B)       Reserved for expansion (0 B)



## New storage volume



1. Type      2. Settings      3. Finish

Select your choice : ⓘ **RAID 1**

**SimplyRAID**  
Single security

**SimplyRAID**  
Double security

**JBOD**

RAID 0

**RAID 1**

RAID 5

RAID 6

Writes the same data on each disk (mirror).  
**A minimum of 2 disks is required to ensure data protection.**

**Capacity**      100%

**Protection**      ☆☆☆☆☆

**Performance**      ☆☆☆☆☆

**Scalability**      ★☆☆☆☆

Available for data (2 TB)      Used for protection (0 B)      Reserved for expansion (0 B)

**Cancel**   **Back**   **Next**

6. Review the summary window then choose **Finish**. A popup window cautions you that all data on the selected disks will be deleted to create the volume. Select **Yes** to build the volume.

## New storage volume



1. Type      2. Settings      3. Finish

Click Finish to confirm your selection.

Selected drive	Drive 3
RAID mode	RAID 1
Protection	No data protection
Available for data	2 TB
Used for protection	0 B
Reserved for expansion	0 B

**All data on the selected disks (Drive 3) will be erased.**

**Cancel**   **Back**   **Finish**

7. Though it is a RAID 1 volume, data is not protected with a single disk.

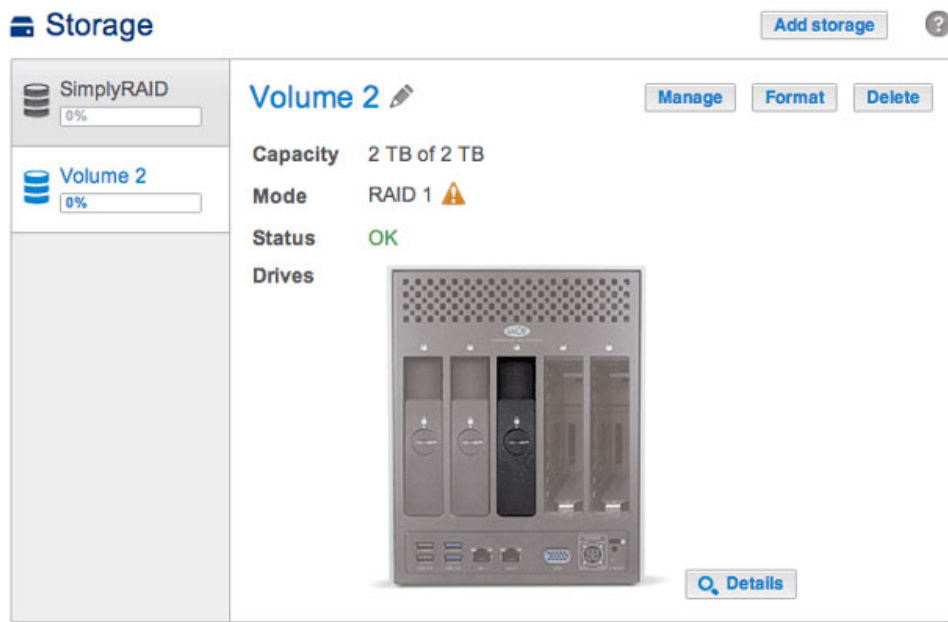

To expand a single-disk volume, see [Hard Disk Expansion: Single-Disk and Unprotected Volumes](#).

## Multiple Volumes

There are many combinations of volumes and RAID configurations available on your LaCie NAS. While this manual cannot list every single option, you can use the steps below as a guide when you set up multiple volumes on your pool of storage.

This example will demonstrate the creation of two volumes using RAID 0 (performance) and SimplyRAID (protection). To add greater performance to this configuration, the administrator can bond the two Ethernet ports and create an iSCSI target on the RAID 0 volume. See [Network](#) and [iSCSI Target](#) for additional instructions. A router that supports port aggregation is required for Ethernet bonding.

### Create the first volume:

1. If you have not inserted the hard drives into the LaCie 5big NAS Pro, please see [Remove/Insert a Hard Disk](#) for basic instructions. For a full explanation of adding disks to the enclosure, see [Connect to the Network: Diskless LaCie 5big NAS Pro](#).
2. Choose **Add storage**.



3. Select **Network volume** and choose **Next**.

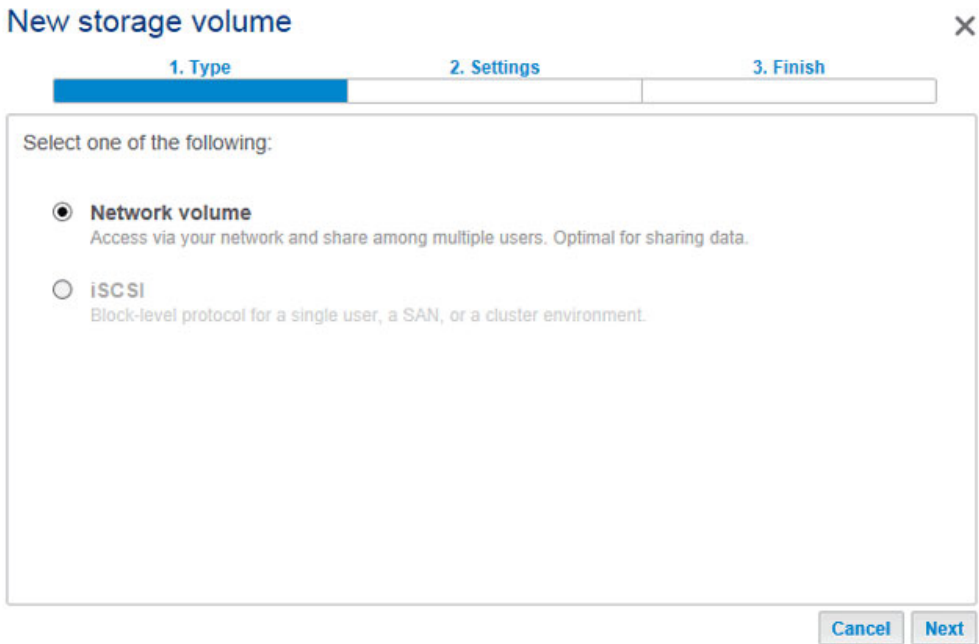

4. For this first volume, all disks are grey. A disk will turn blue once the box is checked.

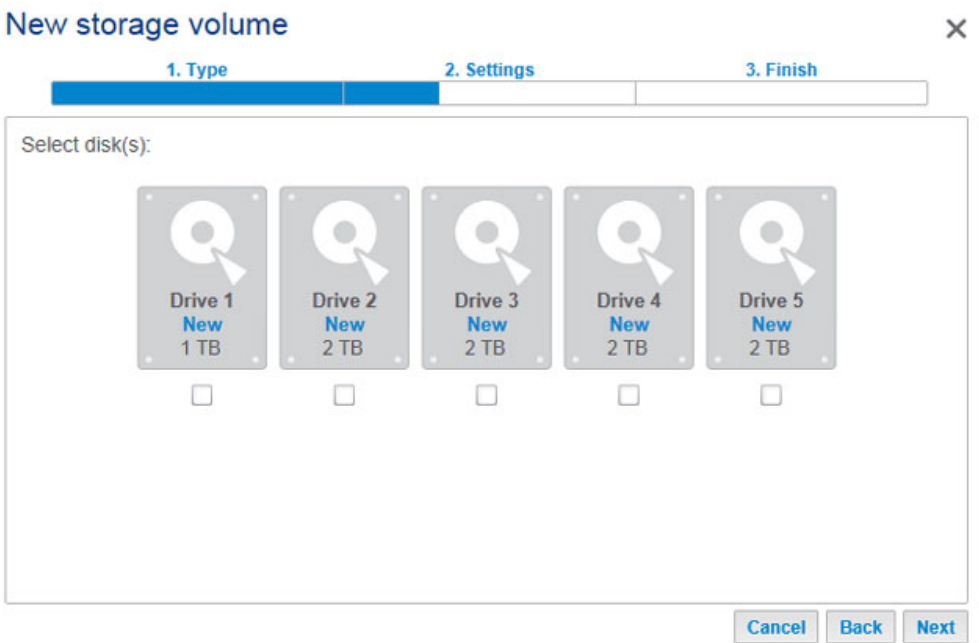

5. Select the check box under the new disks and choose **Next**. In this example, we will create a RAID 0 volume using the first two disks.

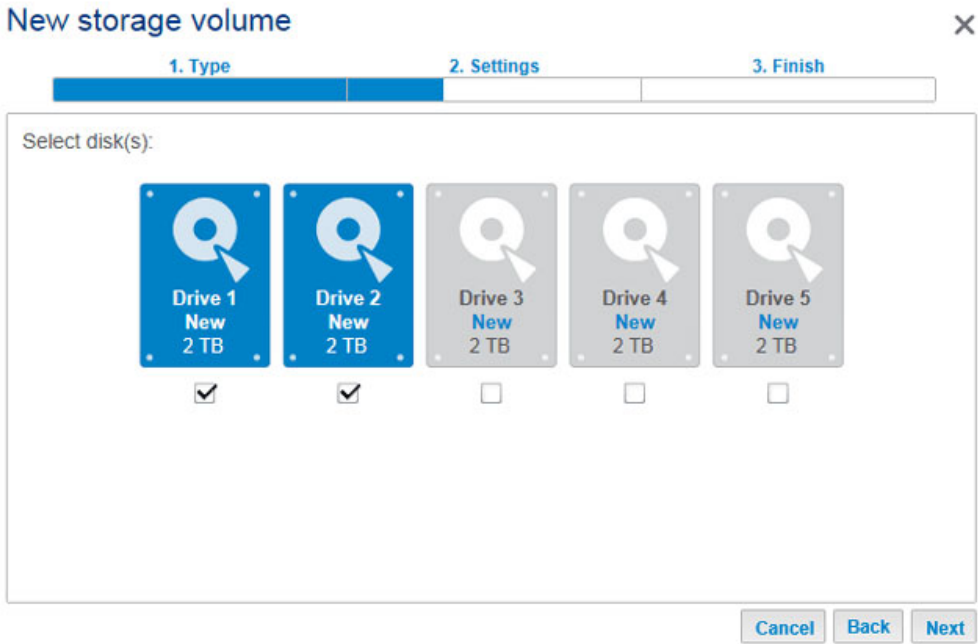

6. Choose **Custom** to select the RAID level. Choose **Next**.

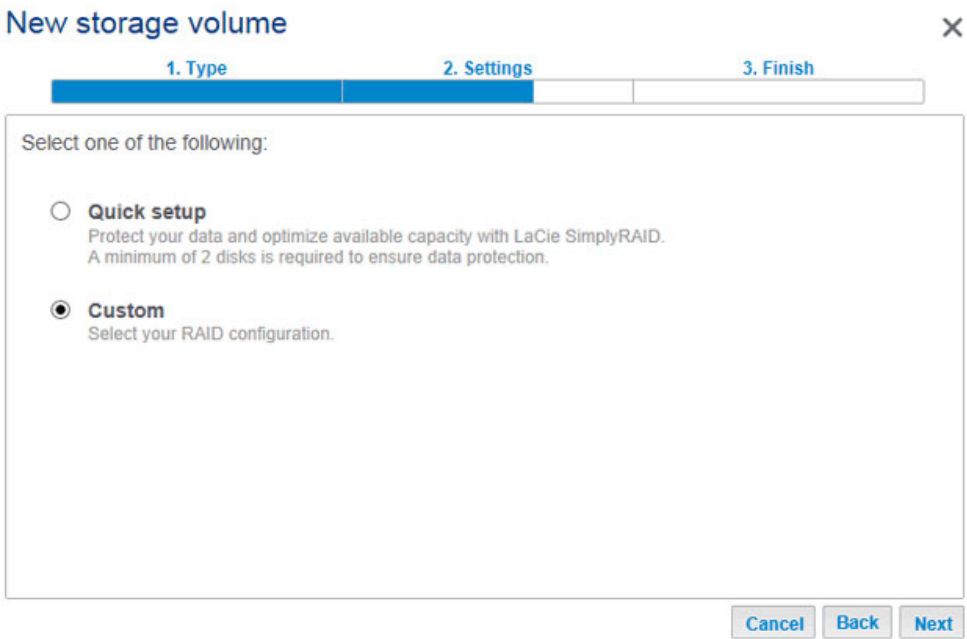

7. Select the RAID level and choose **Next**. This example shows RAID 0.

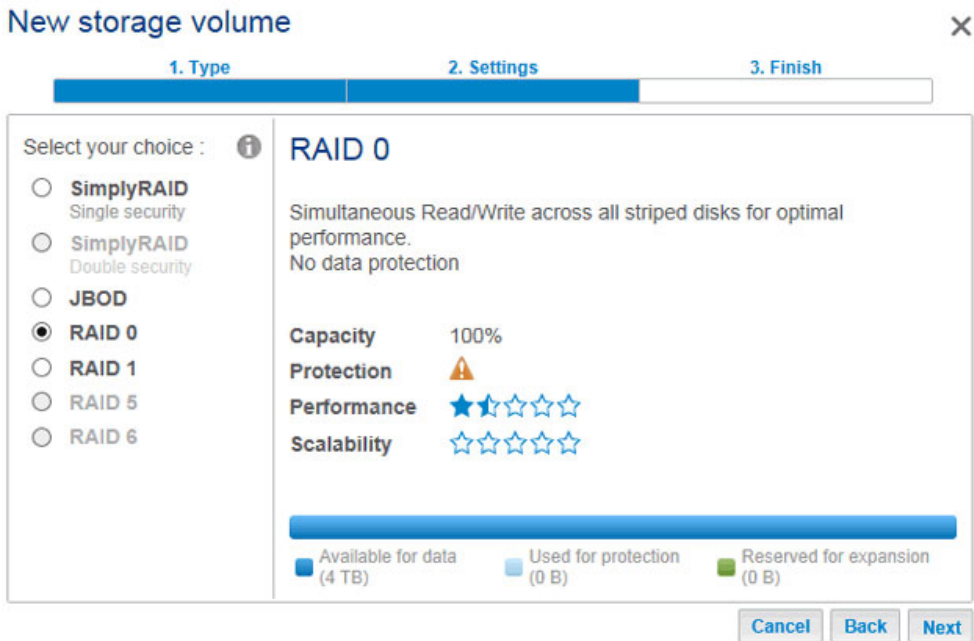

8. Review the summary window then choose **Finish**. A popup window cautions you that all data on the selected disks will be deleted to create the volume. Select **Yes** to build the volume.

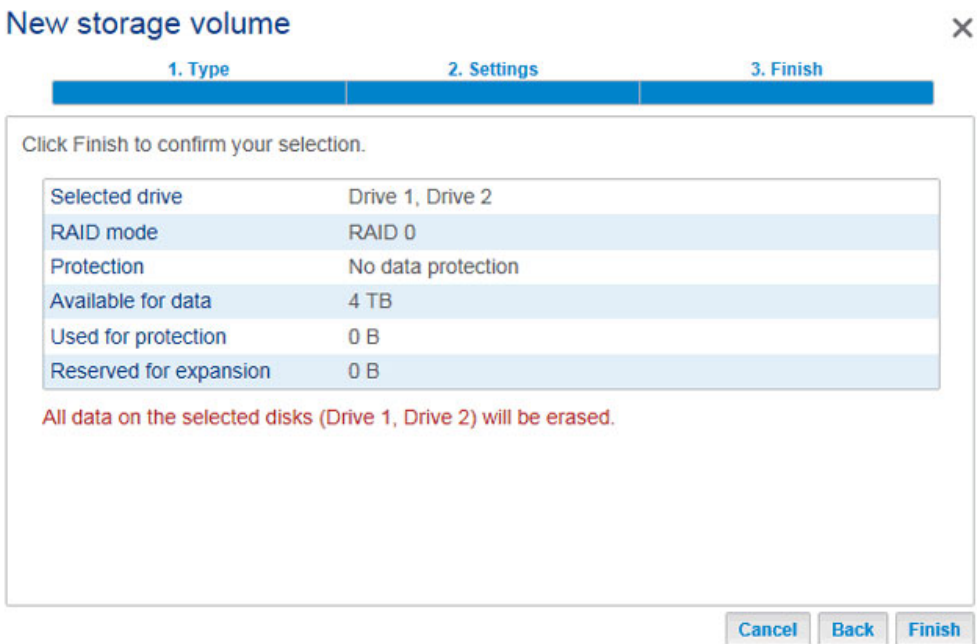

9. A RAID 0 volume takes less than five minutes to build. Note that the first volume has been created using the two hard drives. There are now three new disks on the top left.

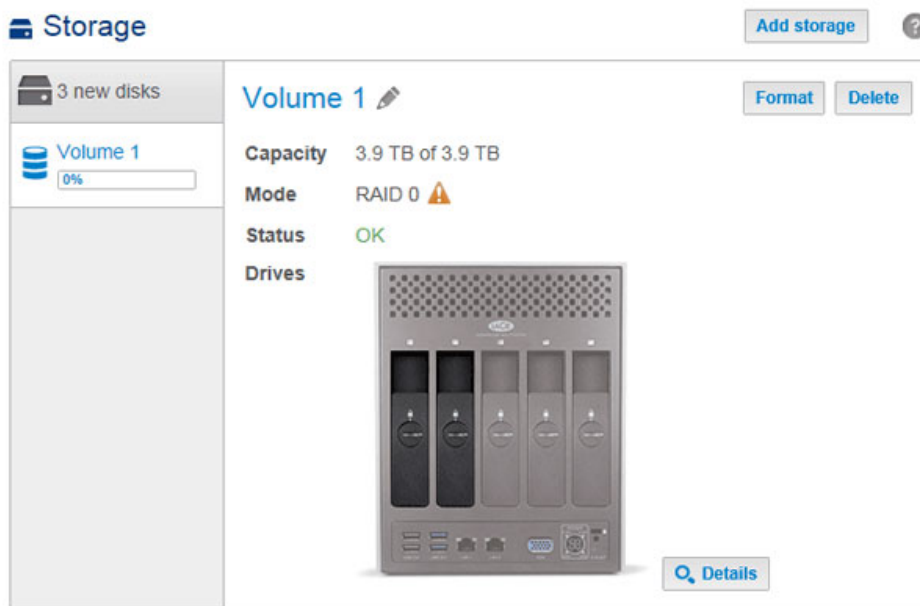

**Create the second volume:**

1. Choose **Add storage**. Important: Do not select an existing volume with **Add storage**. Doing so could risk deleting the existing volume and its data.



2. Select **Network volume** and choose **Next**.
3. Note that the disks in the first volume are not available. Select the check box under the disks you want to use for the volume then choose **Next**. In this example, we will use the remaining three disks to create a SimplyRAID volume.

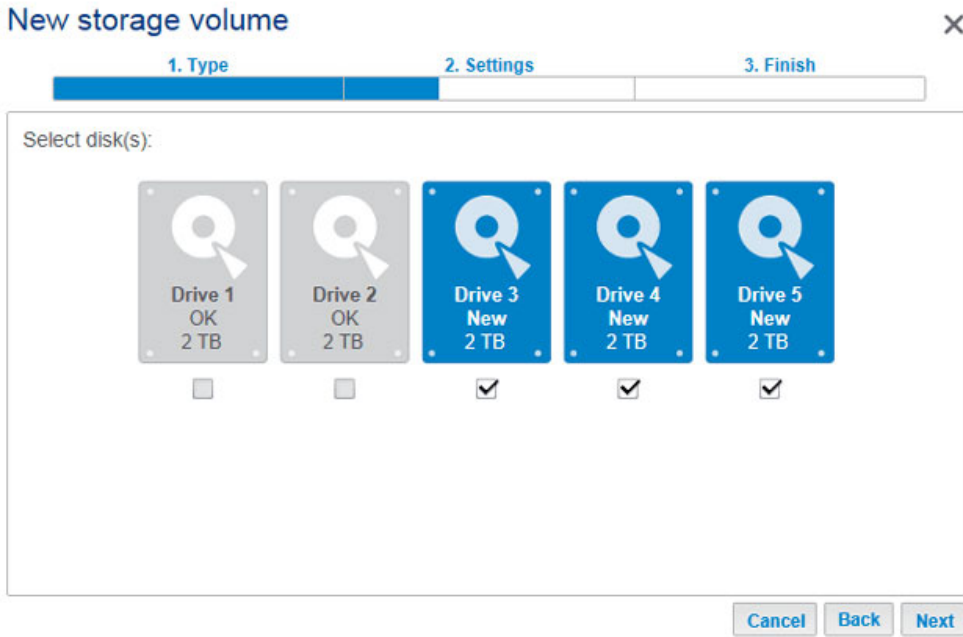

4. Select **Quick setup** for SimplyRAID and choose **Next**.

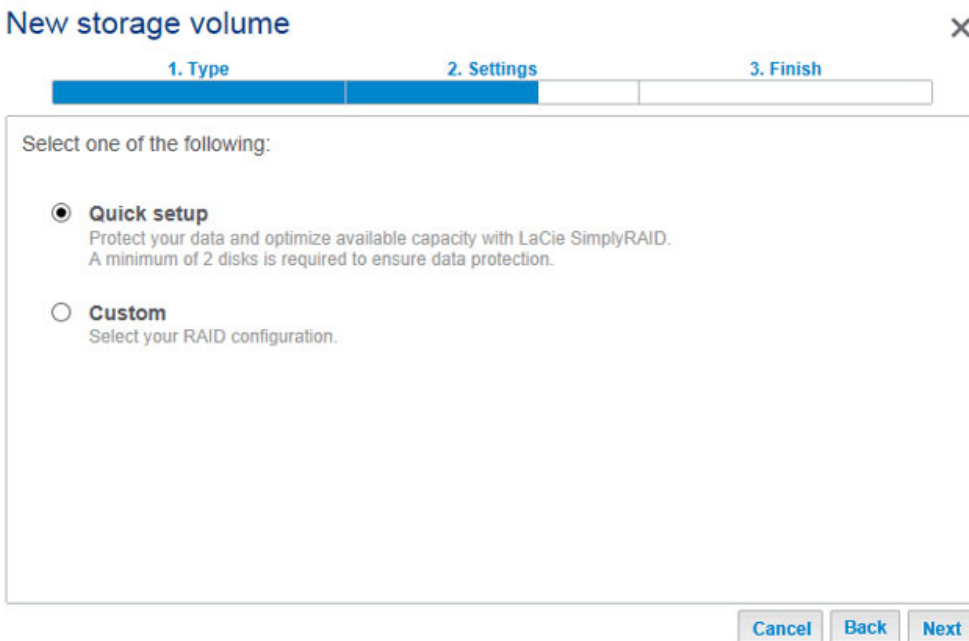

5. Review the summary window then choose **Finish**. A popup window cautions you that all data on the selected disks will be deleted to create the volume. Select **Yes** to build the volume.



## New storage volume



1. Type

2. Settings

3. Finish

Click Finish to confirm your selection.

Selected drive	Drive 3, Drive 4, Drive 5
RAID mode	SimplyRAID - Single security
Protection	Protected if one disk fails
Available for data	4 TB
Used for protection	2 TB
Reserved for expansion	0 B

All data on the selected disks (Drive 3, Drive 4, Drive 5) will be erased.

Cancel Back Finish

6. A protected volume will take time to synchronize. Note that both volumes have been created and are ready for use.



Storage

Add storage



Volume 1  
0%

Volume 2  
0%

### Volume 2

Manage Format Delete

**Capacity** 3.9 TB of 3.9 TB

**Mode** SimplyRAID

**Status** Synchronizing (0.1%)

**Drives**

[Details](#)

## Synchronizing Times

Synchronizing a volume can take five minutes to many hours, depending on the level of RAID, the capacity of the hard disks in the volume, and your LaCie NAS's available resources (concurrent tasks such as backups or torrent downloads will slow synchronizing). For example, creating an unprotected RAID volume takes less than five minutes while RAID 6 with large capacity disks can run for one or more days. Note that you can access the volume while it is synchronizing.

# HARD DISK EXPANSION: SINGLE-DISK AND UNPROTECTED VOLUMES

Review the information below before attempting to add hard disks to a single-disk or unprotected volume.

**Important info on NAS Backup:** It is recommended that all users back up data to DAS or another NAS as further protection against disk failure or secondary points of failure (e.g. hardware, network, etc.). See [Backup Jobs](#) for details.

## REMOVING HEALTHY DISKS FROM AN UNPROTECTED VOLUME

An unprotected volume can be:

- SimplyRAID single-disk
- RAID 1 single-disk
- JBOD
- RAID 0

**Removing a healthy hard disk from an unprotected volume while the LaCie 5big NAS Pro is powered on will delete all of the volume's data.** While removing healthy disks is not recommended, you can avoid losing data by shutting down the LaCie NAS first. Return the hard drives to their proper bays before powering on the LaCie NAS.

Additionally, powering on the LaCie 5big NAS Pro with a missing disk in an unprotected volume will break its RAID and all data will be lost.

# HARD DISK EXPANSION

SimplyRAID



The screenshot above shows a single-disk volume configured for LaCie SimplyRAID (for instructions on how to change the name of the volume from the default to *SimplyRAID*, see [Volume Tools](#)). Follow the steps below to add one or more drives to your single-disk volume:

1. Insert a new hard drive into the next available drive slot in your LaCie 5big NAS Pro (see [Remove/Insert a Hard Disk](#) for instructions). Following the disk installation, the **Dashboard > Storage** page should display at least one *New* hard drive.

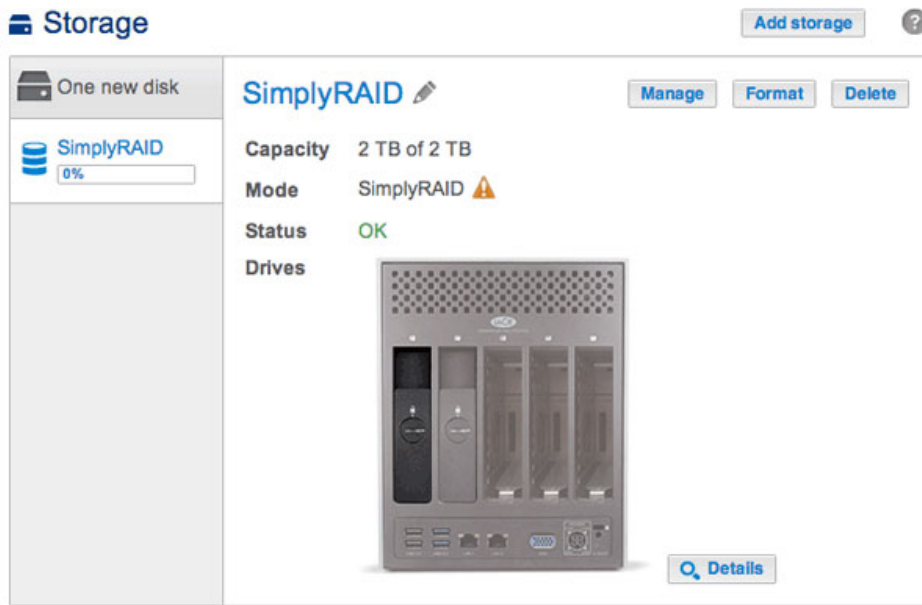

2. Choose **Manage**.
3. Select **Add drive** and choose **Next**.

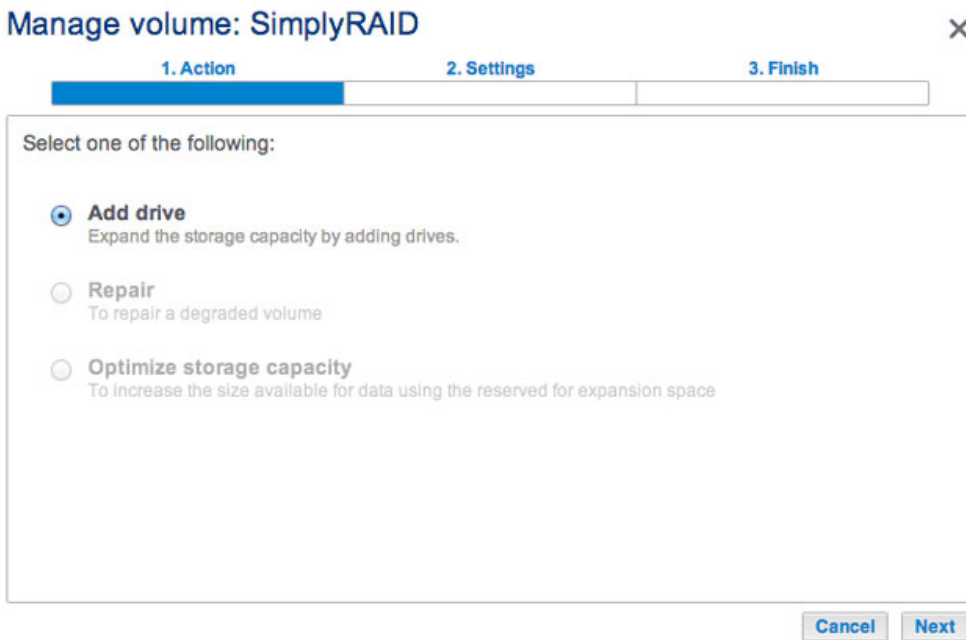





4. Select the new hard drive(s) and choose **Next**.

## Manage volume: SimplyRAID



1. Action      2. Settings      3. Finish

Select the disks that you want to add to the volume:

 Drive 1 OK 2 TB	 Drive 2 New 2 TB	 Drive 3 Empty	 Drive 4 Empty	 Drive 5 Empty
<input checked="" type="checkbox"/>	<input checked="" type="checkbox"/>	<input type="checkbox"/>	<input type="checkbox"/>	<input type="checkbox"/>

Cancel   Back   Next

5. Review the summary page and choose **Finish**. Choose **Yes** at the prompt to confirm the RAID.

## Manage volume: SimplyRAID



1. Action      2. Settings      3. Finish

Click Finish to confirm your selection.

Selected drive	Drive 2
RAID mode	SimplyRAID - Single security
Protection	Protected if one disk fails ⓘ
Available for data	2 TB
Used for protection	2 TB ⓘ
Reserved for expansion	0 B

Changes will be applied when synchronization is complete.

**All data on the selected disks (Drive 2) will be erased.**

Cancel   Back   Finish

You can use the volume during the RAID syntonization.

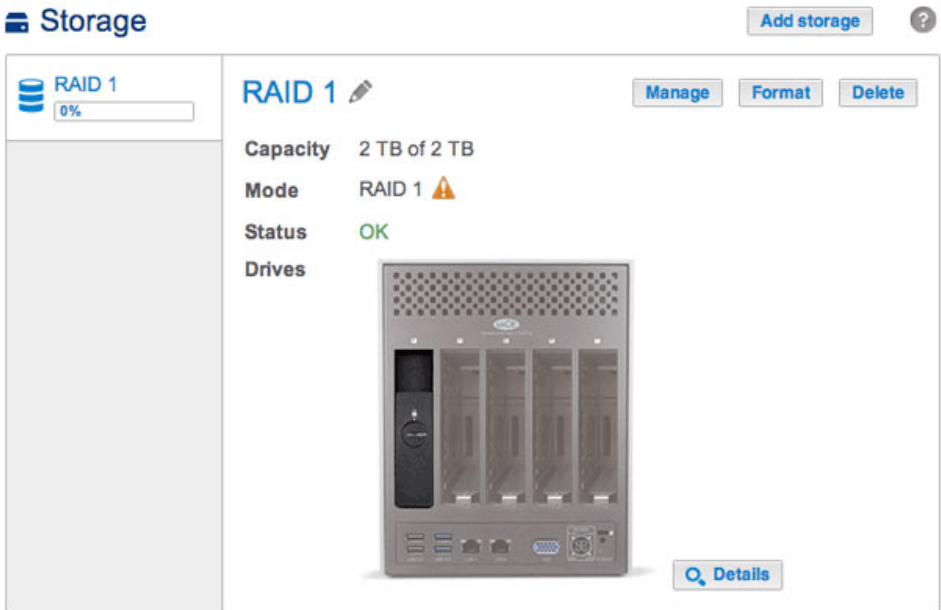

The screenshot above shows a single-disk volume configured for RAID 1 (for instructions on how to change the name of the volume from the default to *RAID 1*, see [Volume Tools](#)). Follow the steps below to add one or more drives to your single-disk volume:

1. Insert a new hard drive into an available drive slot in your LaCie 5big NAS Pro (see [Remove/Insert a Hard Disk](#) for instructions). Following the disk installation, the **Dashboard > Storage** page should display at least one *New hard drive*.

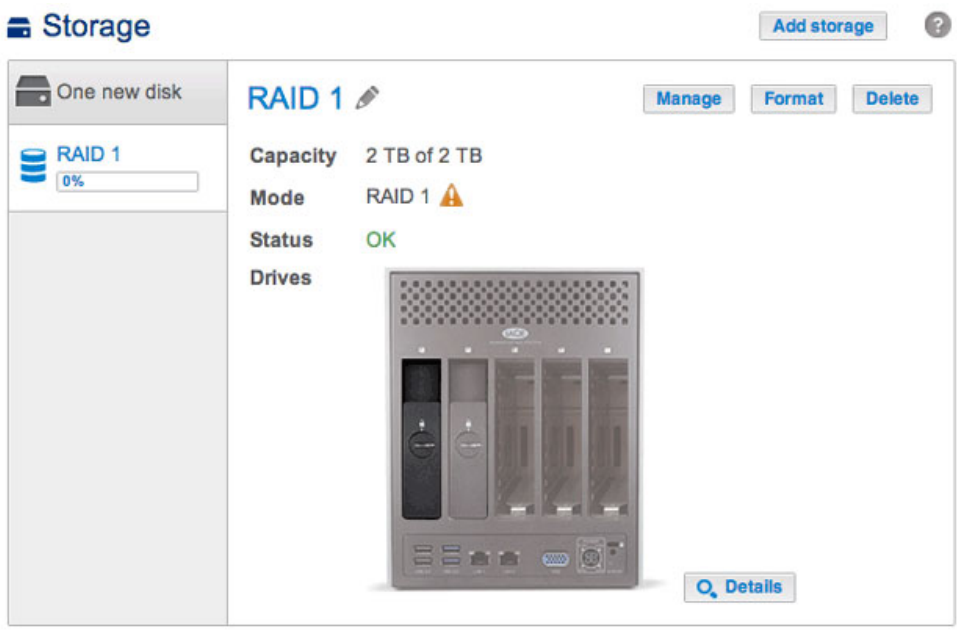

2. Choose **Manage**.
3. Select **Add drive** and choose **Next**.

## Manage volume: RAID 1



1. Action

2. Settings

3. Finish

Select one of the following:

- Add drive**  
Expand the storage capacity by adding drives.
- Repair**  
To repair a degraded volume
- Optimize storage capacity**  
To increase the size available for data using the reserved for expansion space

Cancel

Next

4. Select the new hard drive(s) and choose **Next**.

## Manage volume: RAID 1



1. Action

2. Settings

3. Finish

Select the disks that you want to add to the volume:



Cancel

Back

Next

5. Select **Increase security** and choose **Next**. IMPORTANT: Choosing **Custom** will bring you to the RAID selection menu. Selecting any RAID configuration via the **Custom** menu will delete all media stored on the original drive.



## Manage volume: RAID 1



1. Action

2. Settings

3. Finish

Select one of the following:

- Expand storage capacity
- Increase security**  
Protect against data loss if one disk fails.
- Custom**  
Select RAID level or add a spare drive.

Cancel Back Next

6. Review the summary page then choose **Finish**. Choose **Yes** at the prompt to confirm the RAID.

## Manage volume: RAID 1



1. Action

2. Settings

3. Finish

Click Finish to confirm your selection.

Selected drive	Drive 2
RAID mode	RAID 1
Protection	Protected if one disk fails ⓘ
Available for data	2 TB
Used for protection	2 TB ⓘ
Reserved for expansion	0 B

Changes will be applied when synchronization is complete.

**All data on the selected disks (Drive 2) will be erased.**

Cancel Back Finish

You can use the volume during the RAID synchronization.

## LACIE 5big NAS Pro



The screenshot above shows a single-disk volume configured for JBOD (for instructions on how to change the name of the volume from the default to *JBOD*, see [Volume Tools](#)). Follow the steps below to add one or more drives to your JBOD volume: A JBOD volume can be expanded with new disks added to the LaCie 5big NAS Pro enclosure.

1. Insert a new hard drive into the next available drive slot in your LaCie 5big NAS Pro (see [Remove/Insert a Hard Disk](#) for instructions). Following the disk installation, the **Dashboard > Storage** page should display at least one *New hard drive*.

## LACIE 5big NAS Pro



2. Choose **Manage**.

3. Select **Add drive** and choose **Next**.



4. Select the new hard drive(s) and choose **Next**.

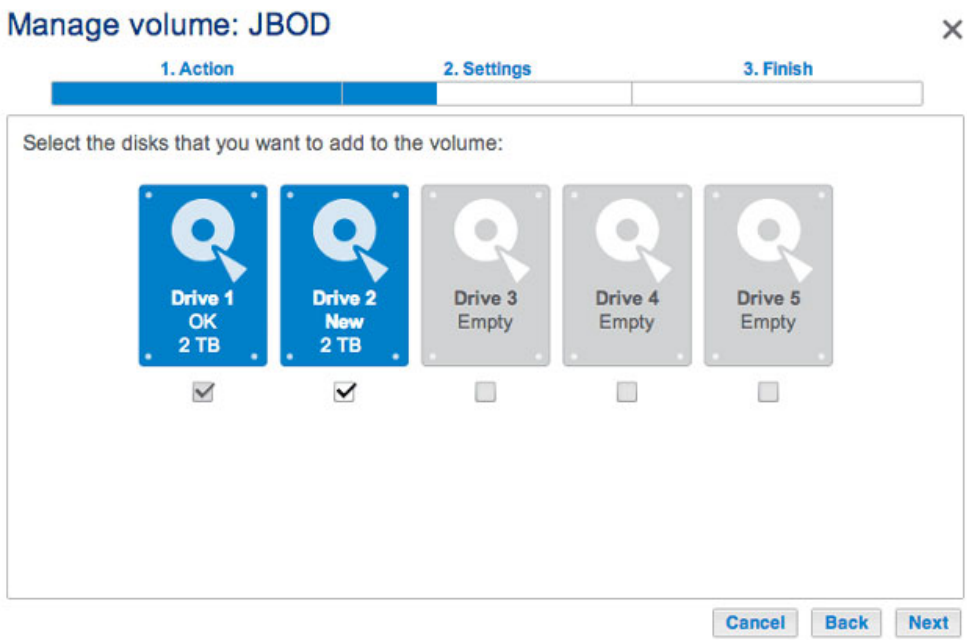

5. Review the summary page then choose **Finish**. Choose **Yes** at the prompt to confirm the RAID.

# Manage volume: JBOD



1. Action

2. Settings

3. Finish

Click Finish to confirm your selection.

Selected drive	Drive 2
RAID mode	JBOD
Protection	No data protection
Available for data	4 TB ⓘ
Used for protection	0 B
Reserved for expansion	0 B

All data on the selected disks (Drive 2) will be erased.

## RAID 0

A RAID 0 volume cannot be expanded with new disks added to the LaCie 5big NAS Pro enclosure and/or swapped for disks of higher capacity.

# HARD DISK EXPANSION AND REPLACEMENT: PROTECTED VOLUMES

Review the instructions below before adding or replacing hard drives.

## REMOVING HEALTHY DISKS FROM A PROTECTED VOLUME

A protected volume can be:

- SimplyRAID (single or double security)
- RAID 1/RAID 1+Spare (two disks minimum)
- RAID 5/RAID 5+Spare
- RAID 6/RAID 6+Spare

**Removing a healthy hard disk from a protected volume while the LaCie 5big NAS Pro is powered on will render the volume unprotected. If the volume has double-disk security, removing two healthy hard disks while the LaCie 5big NAS Pro is powered on will render the volume unprotected.** While removing healthy disks is not recommended, you can avoid breaking the RAID by shutting down the LaCie NAS first. Return the hard drives to their proper bays before powering on the LaCie NAS.

If a healthy disk has been removed while the LaCie 5big NAS Pro is powered on, you can reinsert it into the enclosure slot and NAS OS will synchronize the RAID. It is important to note that during synchronization:

- NAS performance is reduced due to a heavier demand upon the CPU
- RAID protection is not available until the synchronization is complete
- Older hard drives can fail, especially models that are not constructed for NAS

**Important info on NAS backup:** It is recommended that all users back up data to DAS or another NAS as further protection against disk failure or secondary points of failure (e.g. hardware, network, etc.). See [Backup Jobs](#) for details.

# HARD DISK EXPANSION AND REPLACEMENT WITH PROTECTED RAID CONFIGURATIONS

**Important info:** If a hard disk that you have purchased from LaCie fails, please contact your LaCie reseller or LaCie Customer Support.

## Expand a volume's storage capacity: Add disks to the enclosure

The instructions below pertain to storage expansion in a LaCie 5big NAS Pro with available or empty drive slots. If you are exchanging an existing hard disk in your enclosure for a hard disk of greater capacity, please follow the instructions in [Repair a failed disk or expand storage capacity](#).

LaCie NAS OS gives you the freedom to configure volumes and RAID for your network. While it is not possible to list every option for expansion, review the examples below and apply them to your situation.

**Adding hard disks:** Make certain to add a new hard drive without data. While data on the volume is safe, performing the steps below will **delete files stored on the new hard drive you are adding to the volume.**

# LACIE 5big NAS Pro

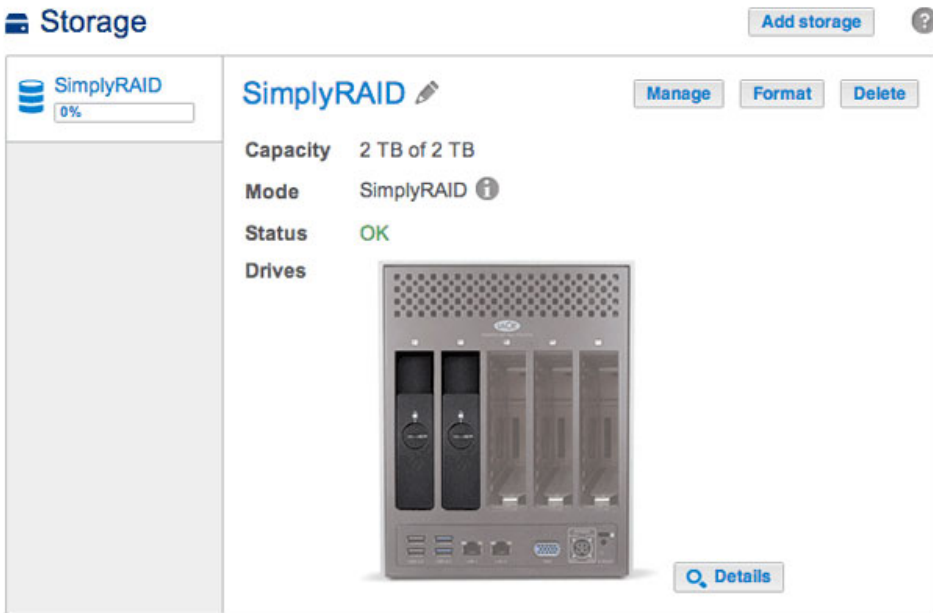

1. Insert one or more hard drives into available drive slots in your LaCie 5big NAS Pro (see [Remove/Insert a Hard Disk](#) for instructions). Following the disk installation, the Storage page should display at least one New hard drive.

# LACIE 5big NAS Pro

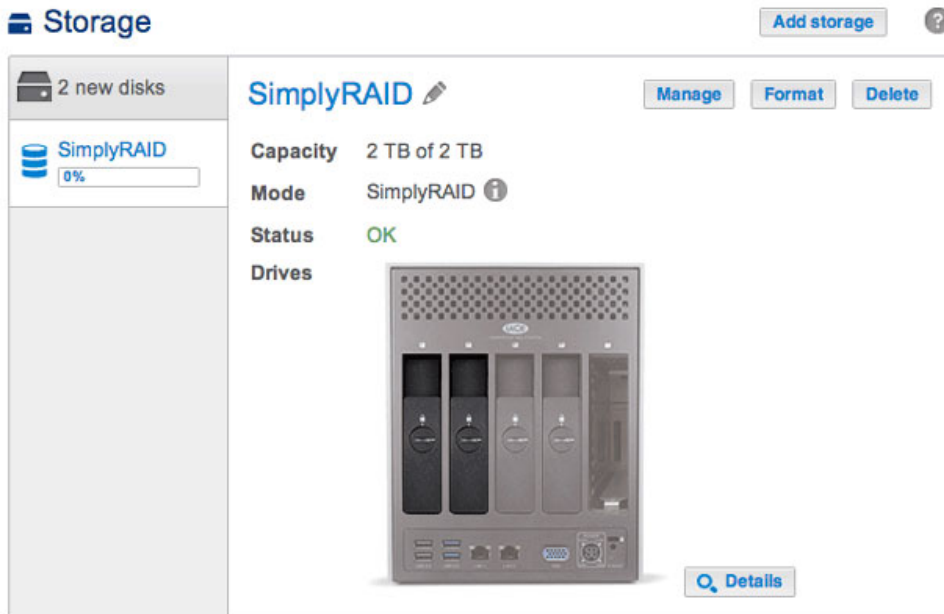

2. Choose **Manage**.
3. Select **Add drive** and choose **Next**.



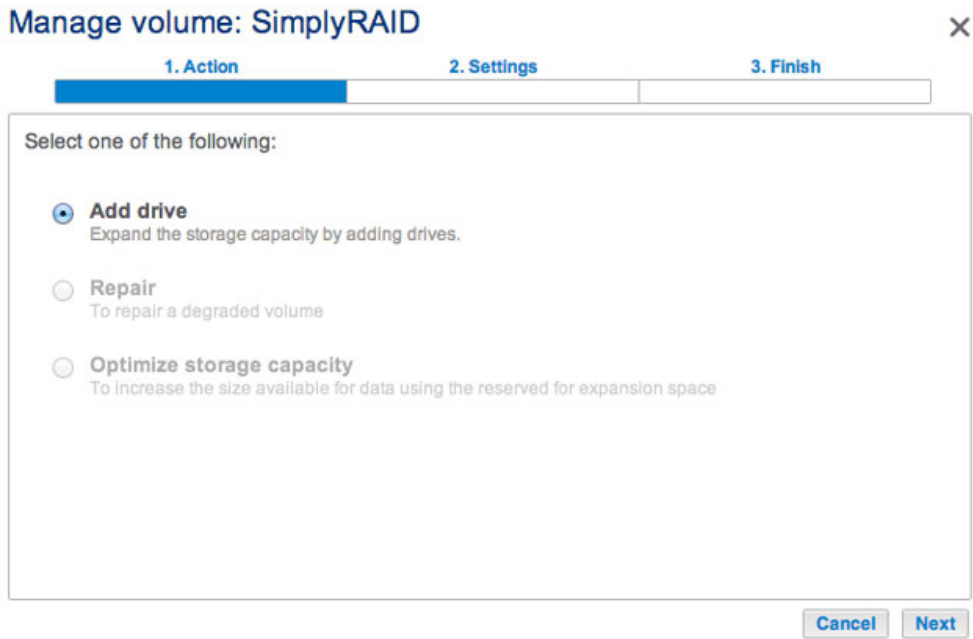

4. Check the boxes for the new hard drive(s) then choose **Next**.

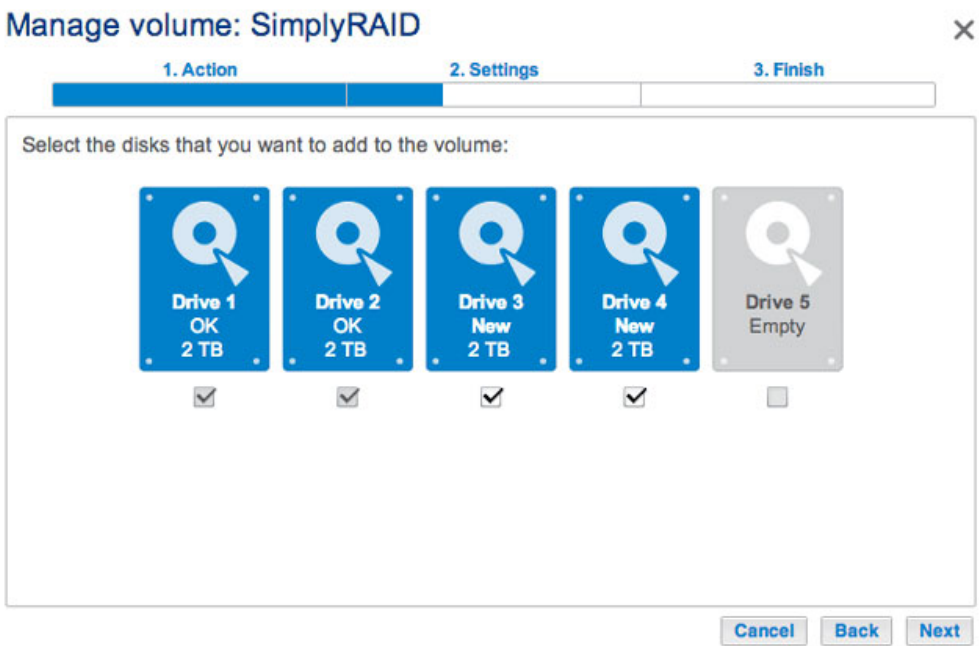

5. Review the summary page and choose **Finish**. Choose **Yes** at the prompt to confirm the RAID.

# Manage volume: SimplyRAID



1. Action

2. Settings

3. Finish

Click Finish to confirm your selection.

Selected drive	Drive 3, Drive 4
RAID mode	SimplyRAID - Single security
Protection	Protected if one disk fails
Available for data	6 TB ⓘ
Used for protection	2 TB
Reserved for expansion	0 B

Changes will be applied when synchronization is complete.

All data on the selected disks (Drive 3, Drive 4) will be erased.

Cancel Back Finish

You can use the volume while it synchronizes the data. NAS performance can be affected during synchronization.

## LACIE 5big NAS Pro

### Storage

Add storage ⓘ

SimplyRAID 0%

SimplyRAID Manage Format Delete

Capacity 2 TB of 2 TB

Mode SimplyRAID

Status Synchronizing (1.4%) ⓘ

Drives

[Details](#)

# LACIE 5big NAS Pro

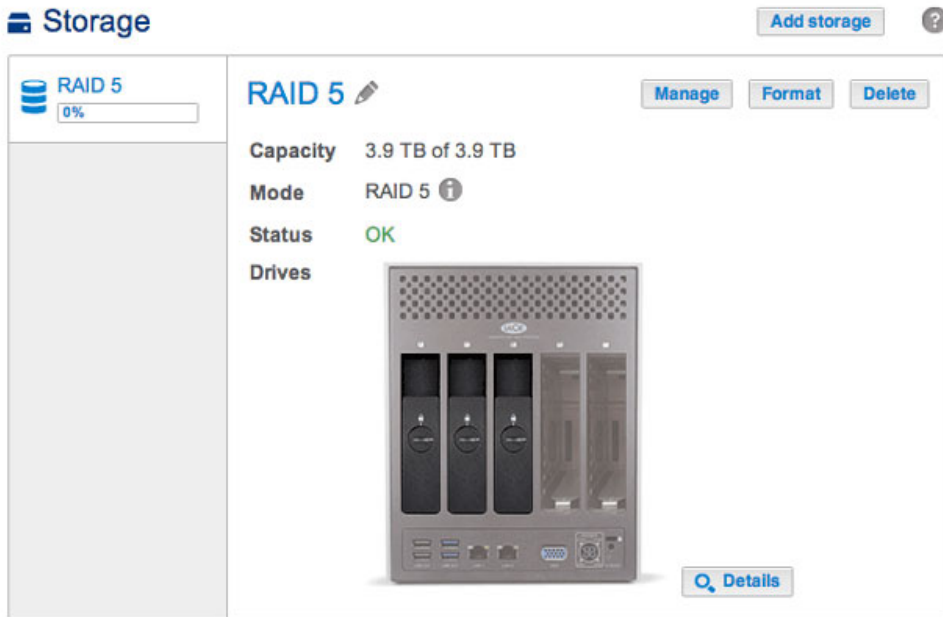

The example below shows how to add a new disk to a RAID 5 volume. You can use the same instructions when adding disks to your Custom RAID volume.

1. Insert one or more hard drives into the next available drive slots in your LaCie 5big NAS Pro (see [Remove/Insert a Hard Disk](#) for instructions). Following the disk installation, the Storage page should display at least one *New* hard drive.

# LACIE 5big NAS Pro

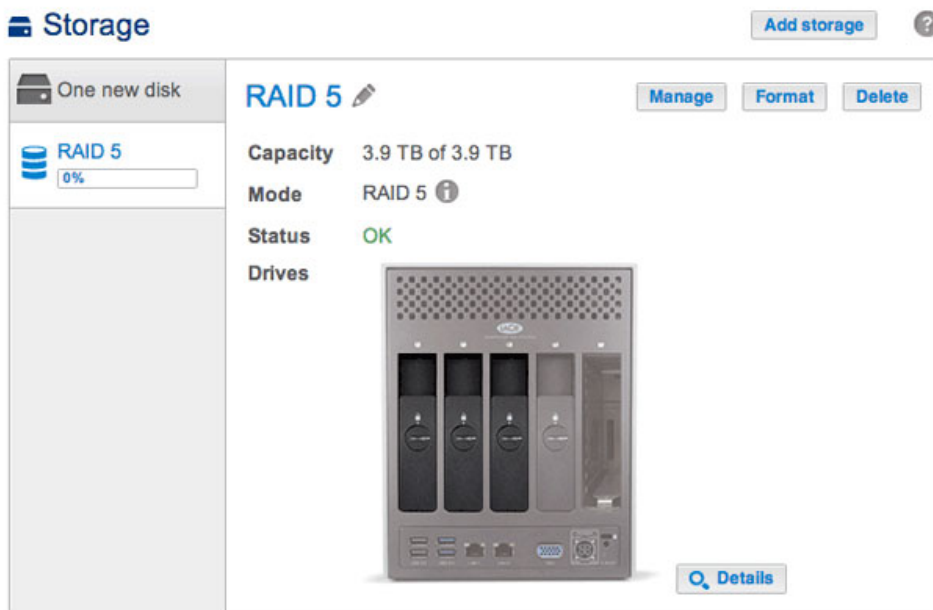

2. Choose **Manage**.
3. Select **Add drive** and choose **Next**.

## Manage volume: RAID 5



1. Action      2. Settings      3. Finish

Select one of the following:

- Add drive**  
Expand the storage capacity by adding drives.
- Repair**  
To repair a degraded volume
- Optimize storage capacity**  
To increase the size available for data using the reserved for expansion space



4. Check the boxes for the new hard drive(s) and choose **Next**.

## Manage volume: RAID 5



1. Action      2. Settings      3. Finish

Select the disks that you want to add to the volume:

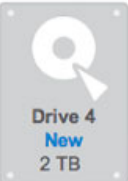
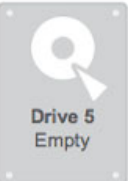
 Drive 1 OK 2 TB	 Drive 2 OK 2 TB	 Drive 3 OK 2 TB	 Drive 4 New 2 TB	 Drive 5 Empty
<input checked="" type="checkbox"/>	<input checked="" type="checkbox"/>	<input checked="" type="checkbox"/>	<input type="checkbox"/>	<input type="checkbox"/>

*A disk that has just been installed is grey and listed as New*

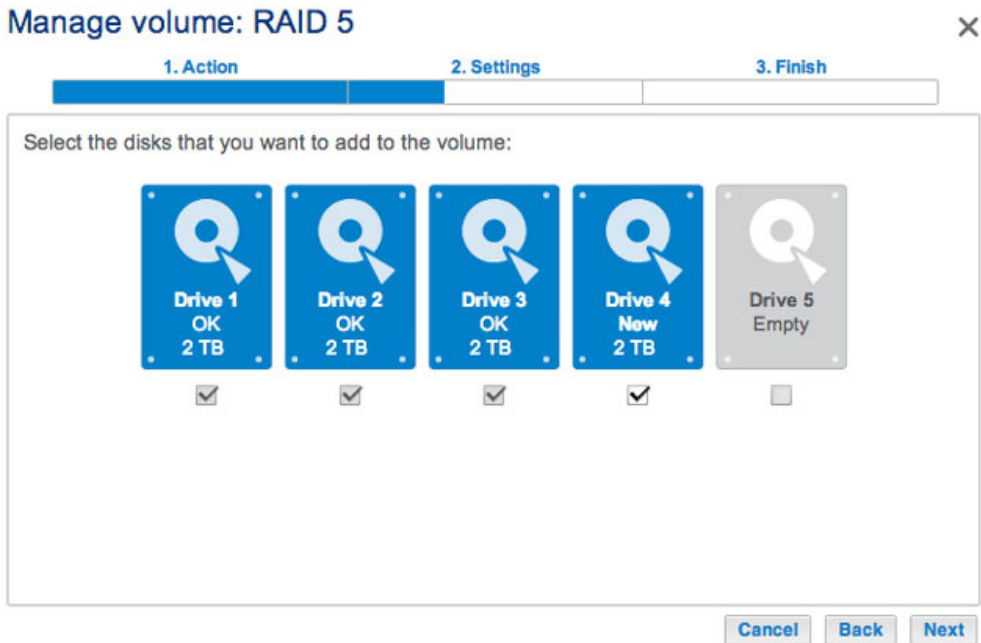

5. To add the new disk(s) to the RAID, choose **Expand storage capacity**. **Important:** Make certain to choose **Expand storage capacity**. Selecting **Increase security** in this window will migrate the RAID from 5 to 6, and selecting **Custom** will create a new RAID volume and delete all existing data.

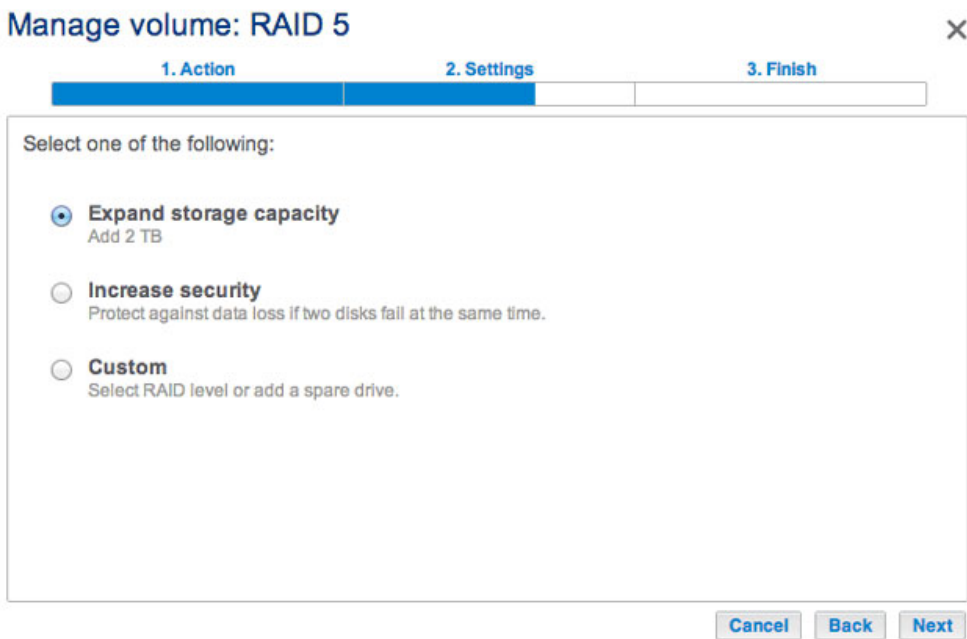

6. Review the summary page to confirm that you are adding the hard drive to your existing RAID volume. Choose the *i* tooltip to review the current capacity. To confirm, choose **Finish**, then **Yes** at the prompt.

## Manage volume: RAID 5



1. Action

2. Settings

3. Finish

Click Finish to confirm your selection.

Selected drive	Drive 4
RAID mode	RAID 5
Protection	Protected if one disk fails
Available for data	6 TB ⓘ
Used for protection	2 TB
Reserved for expansion	0 B

Changes will be applied when synchronization is complete.

All data on the selected disks (Drive 4) will be erased.

Cancel Back Finish

## Manage volume: RAID 5



1. Action

2. Settings

3. Finish

Click Finish to confirm your selection.

Selected drive	Drive 4
RAID mode	RAID 5
Protection	Protected if one disk fails
Available for data	6 TB ⓘ
Used for protection	2 TB
Reserved for expansion	0 B

Current 4 TB

Changes will be applied when synchronization is complete.

All data on the selected disks (Drive 4) will be erased.

Cancel Back Finish

### ***View your current capacity via the tooltip***

You can access data while the volume is resized. The total capacity of the volume will be available once the synchronization is complete.

Storage

Add storage



RAID 5

0%

RAID 5

Manage

Format

Delete

Capacity 4.5 TB of 4.5 TB

Mode RAID 5

Status Resizing

Drives



Details

## Repair a failed disk or expand storage capacity

Follow the instructions below to:

- Replace a failed hard disk.
- Expand a volume's total storage capacity by removing a hard disk and replacing it with a larger capacity hard disk.

**Important info:** It is not possible to replace existing hard disks with lower capacity hard disks.

**Important info:** All data stored on the replacement disk will be deleted.

### Hot-swapping

If your volume is protected, you can remove one hard disk from the volume while the product is turned on without losing data. This process is referred to as “hot-swapping”. It is highly recommended that hot-swapping be performed when replacing or expanding a hard disk that is part of a protected volume.

When replacing or expanding hard drives in a protected RAID volume:

- Perform the operation while the LaCie NAS is powered on (hot-swapping).
- Use clean hard drives (without data).



# LACIE 5big NAS Pro

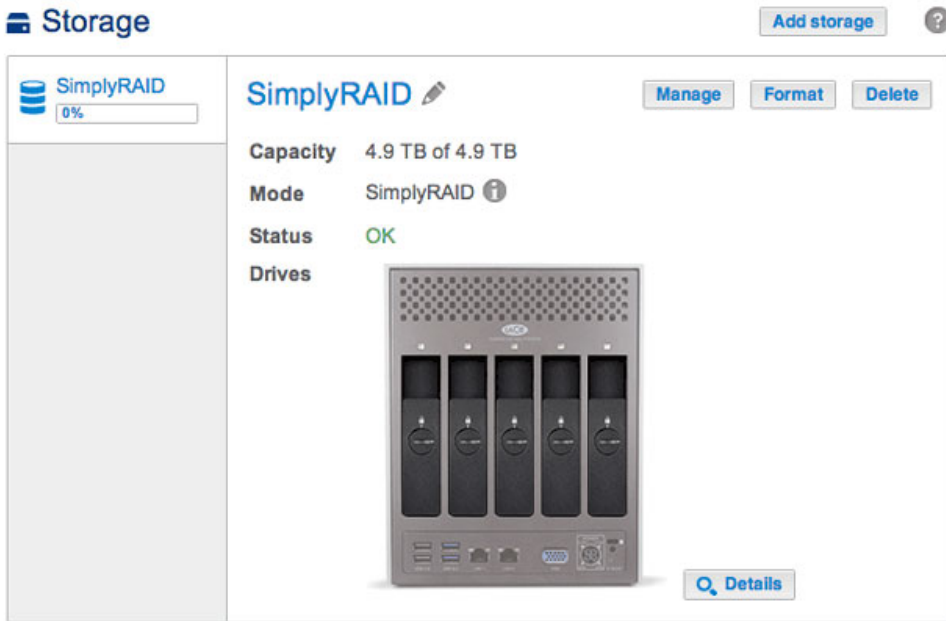

The SimplyRAID volume in the example below has five disks: four 2TB disks and one 1TB disk.

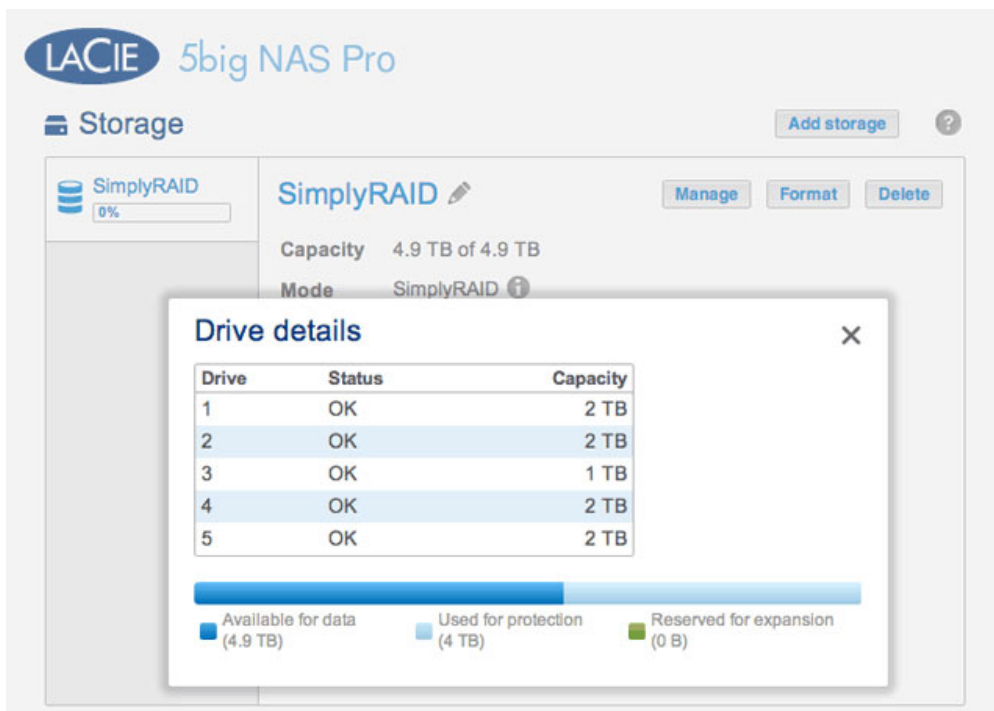

1. Remove the disk that you want to replace. The Storage page will alert you that the volume is no longer protected.

# LACIE 5big NAS Pro

## Storage

Add storage



SimplyRAID 0%

SimplyRAID

Manage Format Delete

Capacity 4.9 TB of 4.9 TB

Mode SimplyRAID

Status **Protected if one disk fails**

Drives



Details

LACIE 5big NAS Pro

Storage Add storage ?

SimplyRAID 0%

SimplyRAID

Manage Format Delete

Capacity 4.9 TB of 4.9 TB

Mode SimplyRAID

Status **Protected if one disk fails**

Drives

Drive details X

Drive	Status	Capacity
1	OK	2 TB
2	OK	2 TB
3	<b>Missing</b>	-
4	OK	2 TB
5	OK	2 TB

**The Details button confirms the Missing disk**

2. Insert the replacement disk per the instructions provided in [Remove/Insert a Hard Disk](#). The new drive will be listed on the Storage page.

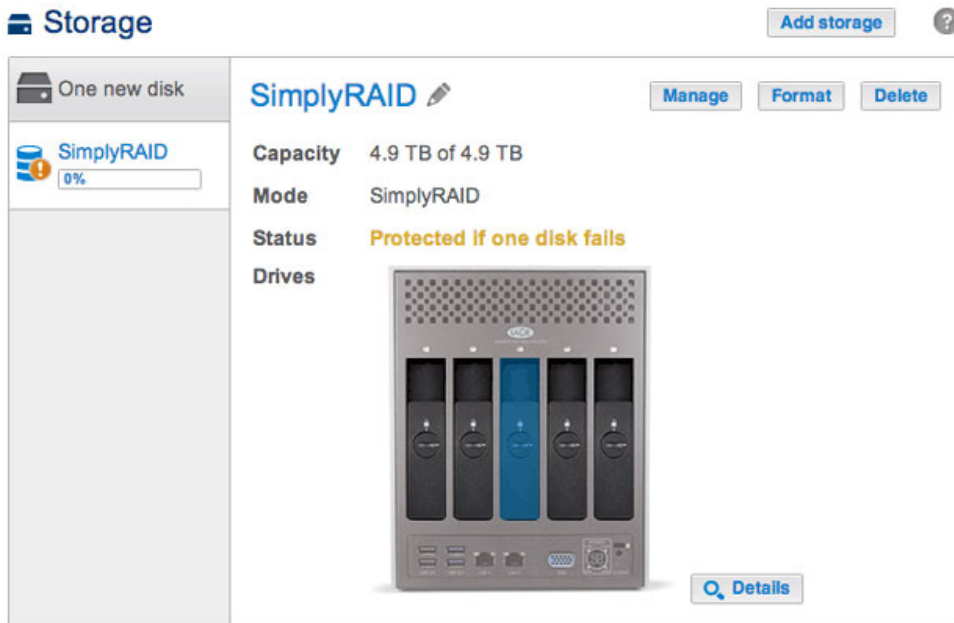

3. Choose **Manage**.
4. Select **Repair** and choose **Next**.

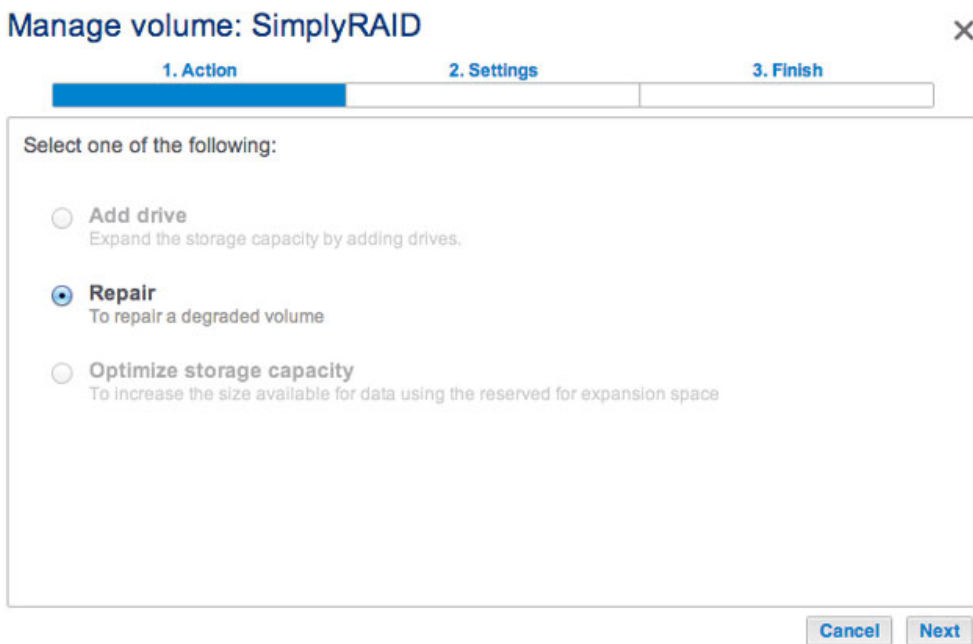

5. Select the replacement disk then choose **Next**.

## Manage volume: SimplyRAID



1. Action

2. Settings

3. Finish

Select the disk that you want to use to repair the volume:

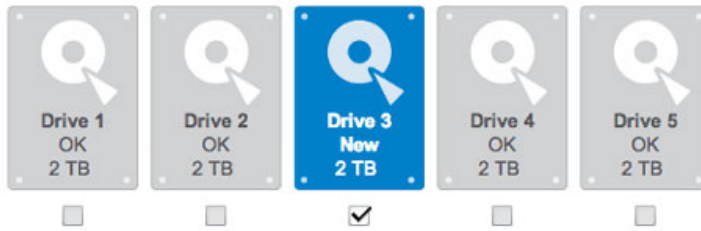

Cancel Back Next

6. Choose **Finish**, then **Yes** at the prompt to confirm the replacement disk.

## Manage volume: SimplyRAID



1. Action

2. Settings

3. Finish

Click Finish to confirm your selection.

Repair the volume when adding the Drive 3.

Data protection is activated only at the end of the synchronization, but your data remains accessible during the process.

**All data on the drive 3 will be erased.**

Cancel Back Finish

The time to synchronize the volume depends upon the amount of disks and the total capacity. The Storage page will update the volume capacity following the synchronization.

Storage

Add storage ?

SimplyRAID 0%

SimplyRAID

Manage Format Delete

Capacity 5.9 TB of 5.9 TB

Mode SimplyRAID

Status OK

Drives



[Details](#)

Storage

Add storage ?

SimplyRAID 0%

SimplyRAID

Manage Format Delete

Capacity 5.9 TB of 5.9 TB

Mode SimplyRAID

Status OK

**Drive details**

Drive	Status	Capacity
1	OK	2 TB
2	OK	2 TB
3	OK	2 TB
4	OK	2 TB
5	OK	2 TB

Available for data (5.9 TB)
 Used for protection (4 TB)
 Reserved for expansion (0 B)

You can continue to access files stored on your LaCie NAS during the RAID synchronization.

# LACIE 5big NAS Pro

## Storage

Add storage ?

The screenshot shows the RAID 5 configuration page. On the left, there are two RAID volume indicators: RAID 0 (0%) and RAID 5 (0%). The main area displays RAID 5 details: Capacity (2 TB of 2 TB), Mode (RAID 5), Status (OK), and a photo of the NAS unit. Action buttons for Manage, Format, and Delete are visible. A Details button is located at the bottom right of the RAID 5 section.

This screenshot shows the same RAID 5 configuration page as above, but with a 'Drive details' dialog box open. The dialog box contains a table of drive information and a progress bar showing storage usage.

Drive	Status	Capacity
1	OK	2 TB
2	OK	2 TB
3	OK	1 TB

Below the table is a progress bar with three segments: Available for data (2 TB), Used for protection (995.4 GB), and Reserved for expansion (2 TB).

### Choosing Details reveals the disks in the volume

The example below shows two volumes, RAID 5 (three disks) and RAID 0 (two disks). The RAID 5 volume has two 2TB hard disks and one 1TB hard disk. The instructions below demonstrate the expansion of the 1TB hard disk to a 2TB hard disk. You can use the same instructions when swapping an existing hard disk in your custom RAID for a failed or higher capacity disk.

**Note on Custom RAID expansion and synchronizing:** The volume must synchronize twice when expanding capacity on a Custom RAID volume.

1. Remove the disk that you want to replace. The Storage page will alert you that the volume is no longer protected.



2. Insert the replacement disk per the instructions provided in [Remove/Insert a Hard Disk](#). The new drive will be listed on the Storage page.



3. Choose **Manage**.

4. Select **Repair** and choose **Next**.

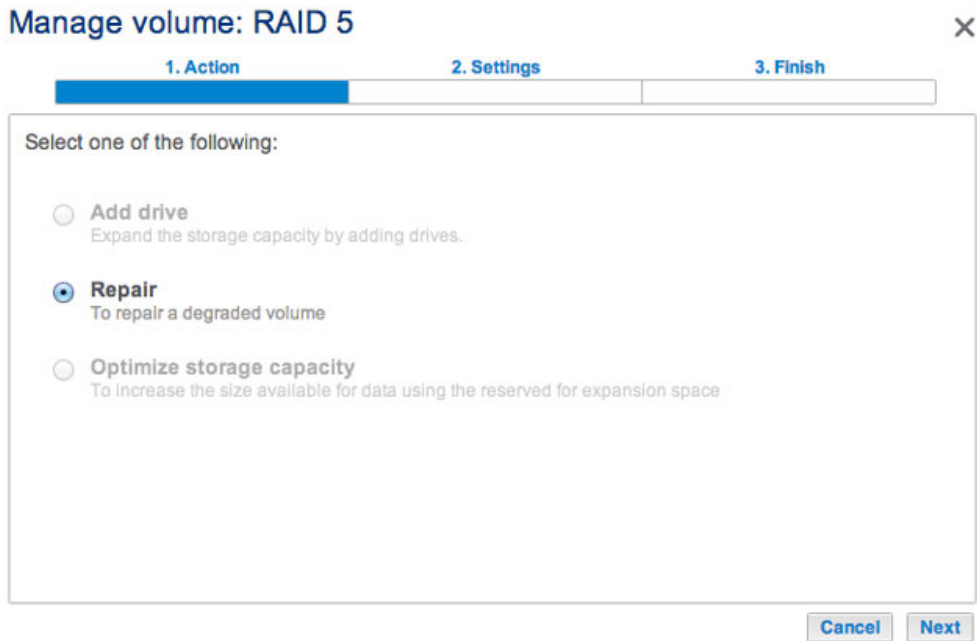

5. Select the replacement disk then choose **Next**.

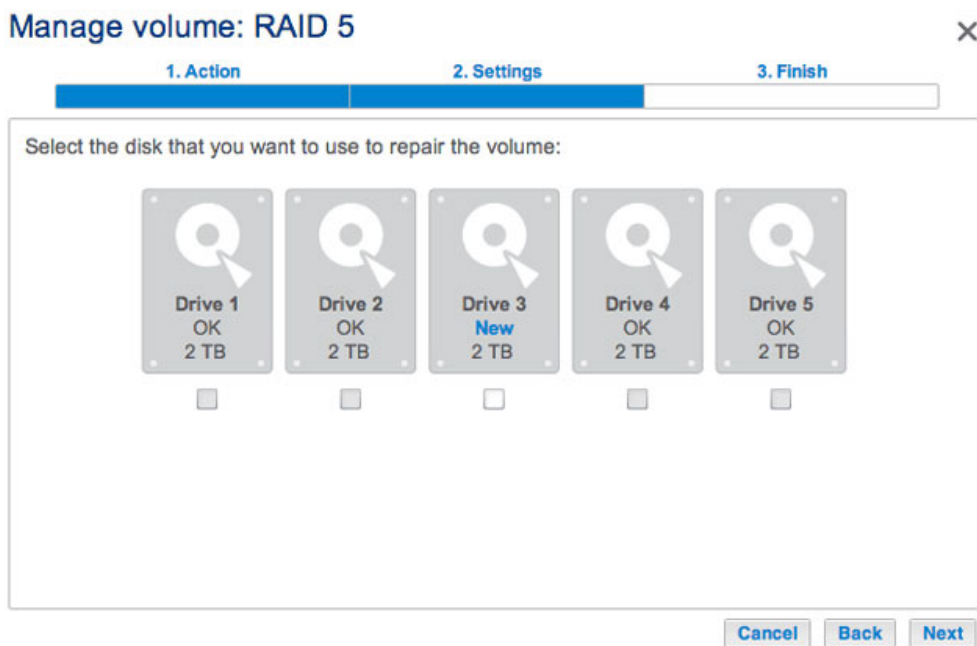

*Only the new disk(s) can be selected*



## Manage volume: RAID 5



1. Action      2. Settings      3. Finish

Select the disk that you want to use to repair the volume:

 Drive 1 OK 2 TB <input type="checkbox"/>	 Drive 2 OK 2 TB <input type="checkbox"/>	 Drive 3 New 2 TB <input checked="" type="checkbox"/>	 Drive 4 OK 2 TB <input type="checkbox"/>	 Drive 5 OK 2 TB <input type="checkbox"/>
---	---	---	---	---

Cancel    Back    Next

6. Choose **Finish**, then **Yes** at the prompt to confirm the replacement disk. The time to synchronize the volume depends upon the amount of disks and the total capacity.

## Manage volume: RAID 5



1. Action      2. Settings      3. Finish

Click Finish to confirm your selection.

Repair the volume when adding the Drive 3.

Data protection is activated only at the end of the synchronization, but your data remains accessible during the process.

**All data on the drive 3 will be erased.**

Cancel    Back    Finish

7. The synchronization is complete once the *Status* is **OK**. However, the volume must still be optimized for the additional capacity.

Storage

Add storage



RAID 0  
0%

RAID 5  
0%

## RAID 5 ✎

**Capacity** 2 TB of 2 TB

**Mode** RAID 5 i

**Status** OK

**Drives**

Manage

Format

Delete

🔍 Details

Storage

Add storage



RAID 0  
0%

RAID 5  
0%

## RAID 5 ✎

**Capacity** 2 TB of 2 TB

**Mode** RAID 5 i

**Status** OK

**Drives**

Manage

Format

Delete

### Drive details ✕

Drive	Status	Capacity
1	OK	2 TB
2	OK	2 TB
3	OK	2 TB

■ Available for data (2 TB)
 ■ Used for protection (995.4 GB)
 ■ Reserved for expansion (3 TB)

*Details confirms the replacement disk, but the capacity is not optimized.*

8. Choose **Manage**.
9. Select **Optimize storage capacity** and choose **Next**.

## Manage volume: RAID 5



1. Action

2. Settings

3. Finish

Select one of the following:

- Add drive**  
Expand the storage capacity by adding drives.
- Repair**  
To repair a degraded volume.
- Optimize storage capacity**  
To increase the size available for data using the reserved for expansion space.

Cancel Next

10. Choose **Finish**.

## Manage volume: RAID 5



1. Action

2. Settings

3. Finish

Click Finish to confirm your selection.

Use reserved for expansion. You will gain approximately 2 TB following the synchronization:



Cancel Back Finish

11. The volume will synchronize once more to update the storage capacity.  
You can access files stored on your LaCie NAS during the RAID synchronization.

## No Replacement Disk - Reset the Volume's RAID

If a hard drive in a protected volume fails and you do not have a replacement disk, you can reset the RAID using the *New storage volume wizard*. Before you reset the RAID, LaCie recommends that you back up your files since all data will be deleted. See [Backup Jobs](#) for instructions on backing up your NAS.

To reset the RAID:

1. Go to **Dashboard > Storage**.
2. Select the volume and choose **Delete**.
3. Confirm in the pop-up window.
4. Go to [New Storage Volume Wizard](#) for instructions on how to create a new RAID volume.

# REMOVE/INSERT A HARD DISK

**Important info:** If a hard disk that you have purchased from LaCie fails, please contact your LaCie reseller or LaCie Customer Support.

## Disk Removal

Follow the directions below to remove a failed hard drive or a hard drive that you wish to swap for another disk with greater capacity.

**Caution:** After continuous use of the LaCie NAS, hard drives may be hot. Use caution when removing a hard drive.

1. Unlock the drive tray using the included disk drawer key to turn the lock until the slot is vertical.

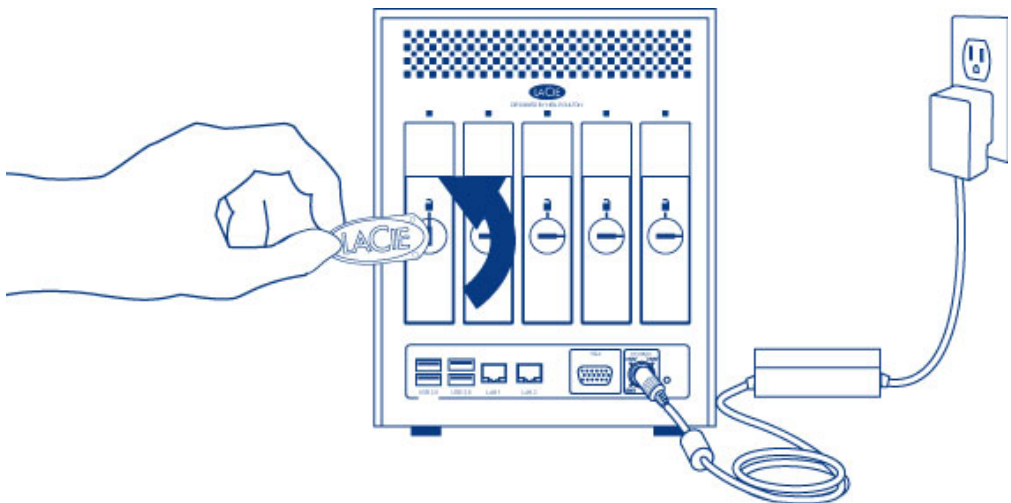

2. Draw out the hard drive tray by inserting your finger into the space behind the tray handle and pulling to disengage the tray.

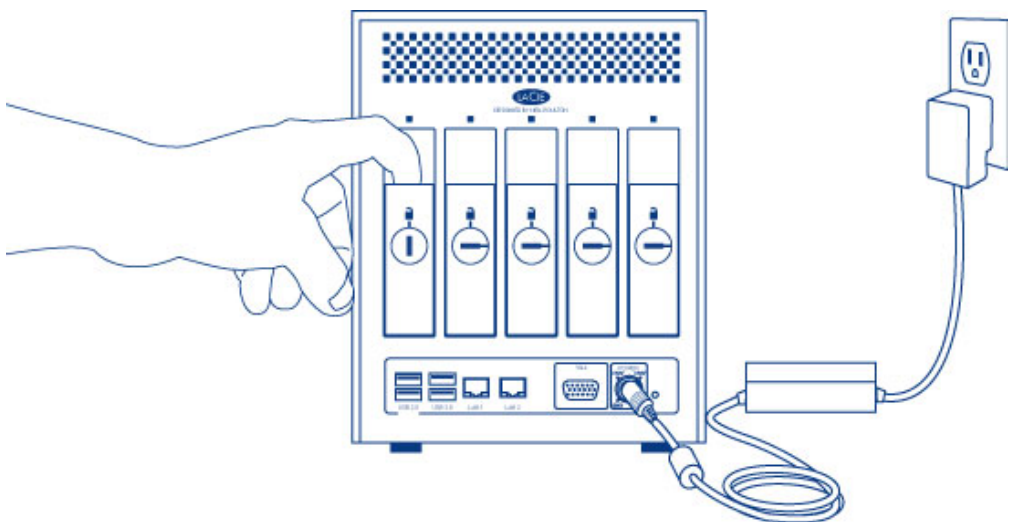

3. Grasp the tray handle and carefully extract the drive.

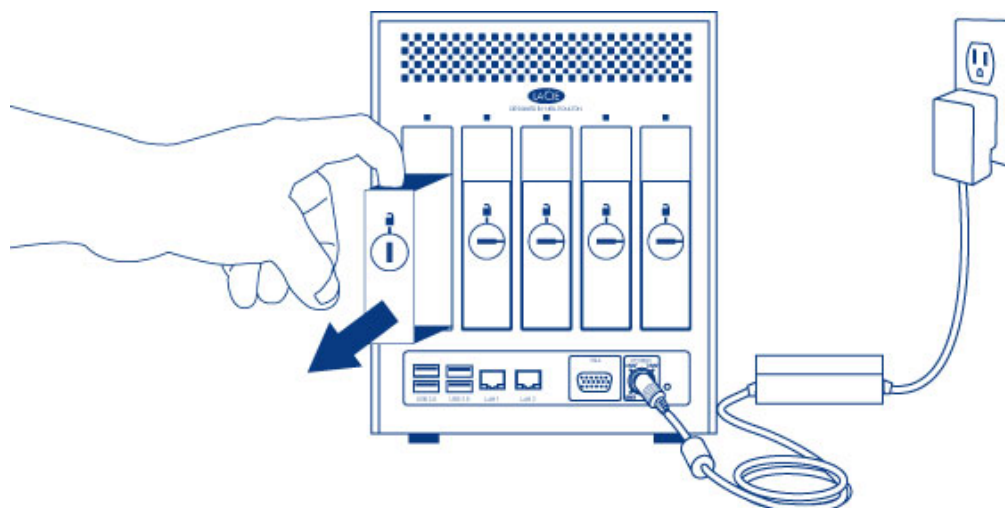

4. To reuse the disk tray, unfasten the drive's screws and affix the new disk to the tray. Detailed instructions are available at [Connect to the Network: Diskless LaCie 5big NAS Pro](#).

## Disk Insertion

For instructions on fixing a hard drive to the disk tray, go to [Connect to the Network: Diskless LaCie 5big NAS Pro](#).

1. Carefully insert the tray into an empty hard drive bay. Make certain to press the drive tray handle firmly until you feel the drive snap into place.

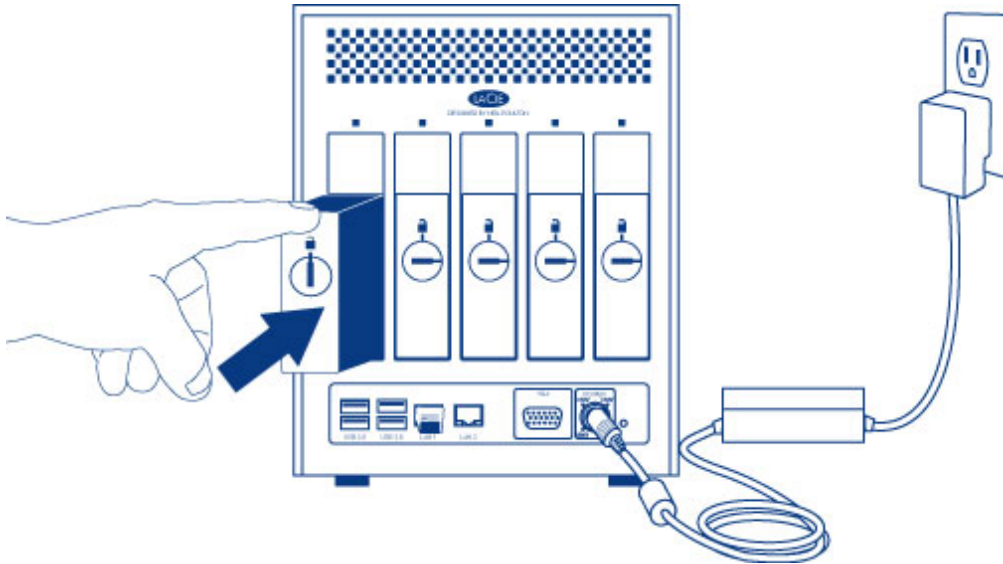

2. Use the disk drawer key to lock the drive.



# ADVANCED STORAGE: DIRECT-ATTACHED STORAGE AND ISCSI

You can use your LaCie NAS to share direct-attached storage (DAS) on the network and to create iSCSI volumes. For details and instructions, see:

- [LaCie NAS Ports and Direct-Attached Storage](#)
- [iSCSI Target](#)



# LACIE NAS PORTS AND DIRECT-ATTACHED STORAGE

Review the table below for the USB and eSATA expansion ports on your LaCie NAS:

Port	LaCie 2big NAS	LaCie 5big NAS Pro
eSATA	1	-
USB 2.0	1	2
USB 3.0	-	2

## DIRECT-ATTACHED STORAGE (DAS)

### Connect



Connect a DAS to the LaCie NAS via USB or eSATA, and it will be listed on the **Dashboard > Storage** page. If you do not see your hard drive listed, confirm that it has been formatted using one of the following file systems:

- FAT32
- NTFS
- HFS+
- EXT2, EXT3, EXT4
- XFS

The name of the DAS cannot be changed on the Storage page.

## DAS share

By default, a DAS becomes a Public share when it is connected to the LaCie NAS.

You can change the DAS from a Public share to a Private share:

1. Go to **Dashboard > Shares** and select the configuration icon (pencil).
2. Choose **Change to private share**.

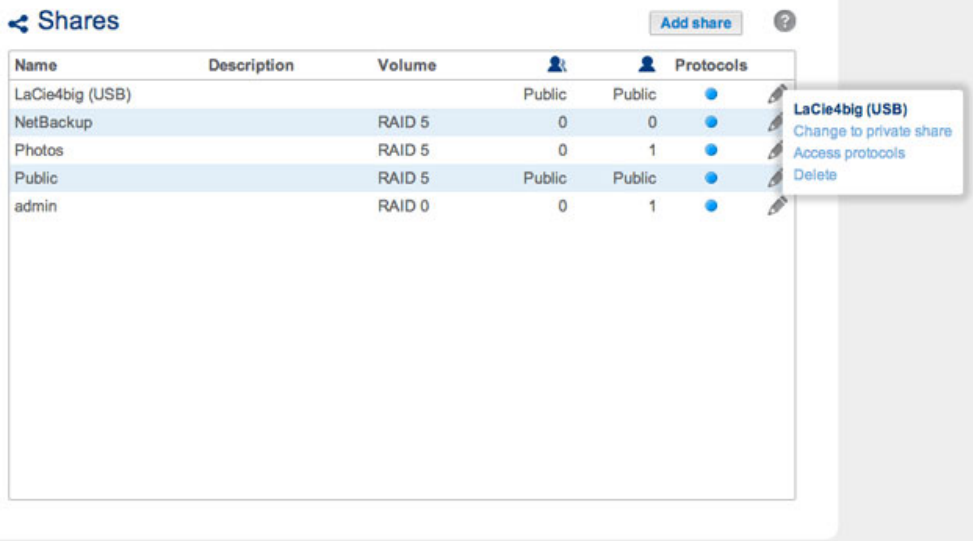

3. Configure access to the share by following the instructions in [Shares](#).

## Disconnect

To avoid damaging your DAS's file system, choose **Eject** before disconnecting it from your LaCie NAS. A prompt will ask you to confirm.

## Multimedia Indexing

You can take an inventory of available multimedia files on your LaCie NAS and all connected external hard drives. See [Reindex the Media Server](#) for details.

## USB PRINTER

Your LaCie NAS features a printer server. See [General Settings](#) for further information.

## ISCSI TARGET

A network share accesses data at the file level (SMB, NFS, or AFP), which is ideal for sharing data among multiple workstations. However, certain working environments require faster transfer rates than file level access can provide. To meet these demands, your LaCie NAS supports the creation of iSCSI targets (Internet Small Computer System Interface). As opposed to network shares, iSCSI targets offer enhanced performance by accessing data at the block level. The NAS can also experience lower demand on its CPU when iSCSI is employed since the data is written directly to the volume. Shares that read and write data at the file level require more processing due to IP and networking protocols.

In addition to requiring faster transfer rates, many professional applications are optimized for use with local storage. Potential compatibility issues with standard network volumes include sharing data and network file formats. Therefore, LaCie NAS iSCSI targets mount on a workstation as local volumes. A workstation that connects to an iSCSI target is called an *iSCSI initiator*.

The iSCSI initiator must format the LaCie NAS's iSCSI target in a non-network file system, such as NTFS, HFS+, or FAT32. For example, an administrator allocates all or a portion of a RAID volume (RAID 1, RAID 5, SimplyRAID, etc.) to an iSCSI target. A workstation on the same network as the LaCie NAS becomes an iSCSI initiator. Therefore, upon first mounting the iSCSI target, the iSCSI initiator is prompted to format the disk, as would happen with standard local storage (direct-attached storage, or DAS).

An administrator can allocate up to 8TB to an iSCSI target.

## ISCSI AND BONDING: ENHANCED PERFORMANCE (5BIG NAS PRO ONLY)

The performance offered by an iSCSI target is ideal for applications that use larger files, such as graphics, photos, and video or, multiple small files in quick succession, as found with professional audio programs. It is possible to boost performance even higher by:

- creating the iSCSI target on a RAID 5 volume.
- configuring the LaCie 5big NAS Pro's dual LAN ports for bonding.

For further information on RAID configurations, go to [5big NAS Pro: About RAID Modes](#). See [Network](#) for details on bonding.

## SHARING AN ISCSI TARGET

In general, an iSCSI target is meant to be used by a single iSCSI initiator. Once the iSCSI initiator disconnects from the iSCSI target, another initiator on the network can connect to it.

Advanced SAN clusters can be configured to manage multiple iSCSI targets and share them among workstations on the network. When adding a LaCie NAS iSCSI target to a SAN cluster, the administrator should choose **Multiple sessions** in the iSCSI target's advanced parameters.

Unless it is properly administered by a SAN cluster, **sharing iSCSI targets can lead to high levels of corrupted data.**

## CREATE AN ISCSI TARGET

Follow the directions below to create an iSCSI target:

1. Go to **Dashboard > Storage** and choose **Add storage**.

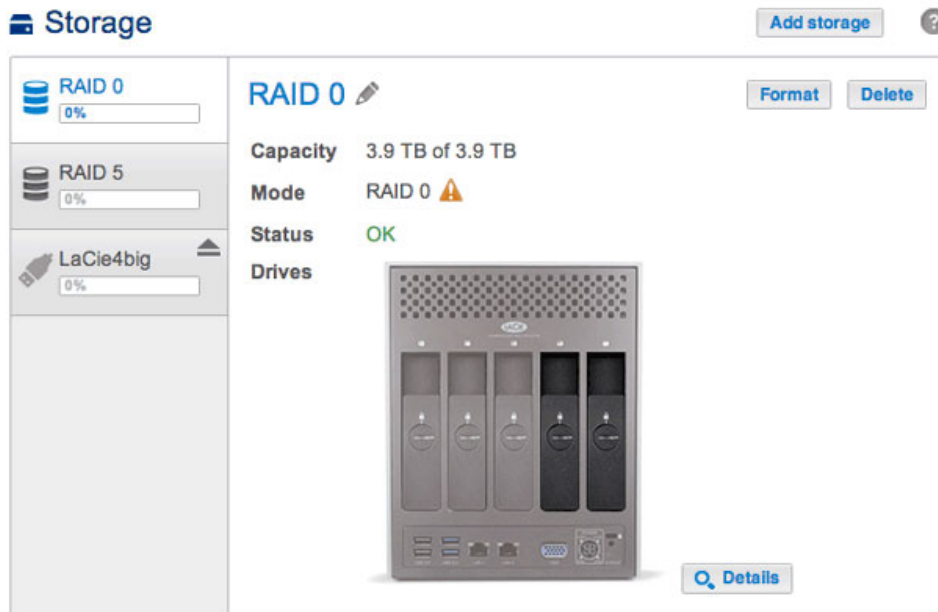

2. Select **iSCSI** and choose **Next**.

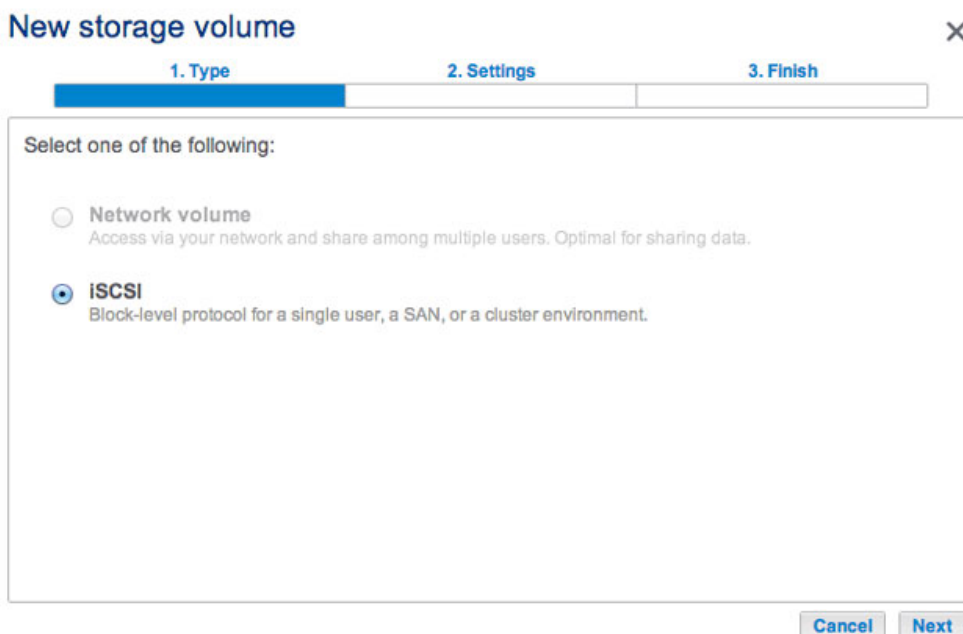

3. Select the volume that will host the iSCSI target and choose **Next**.

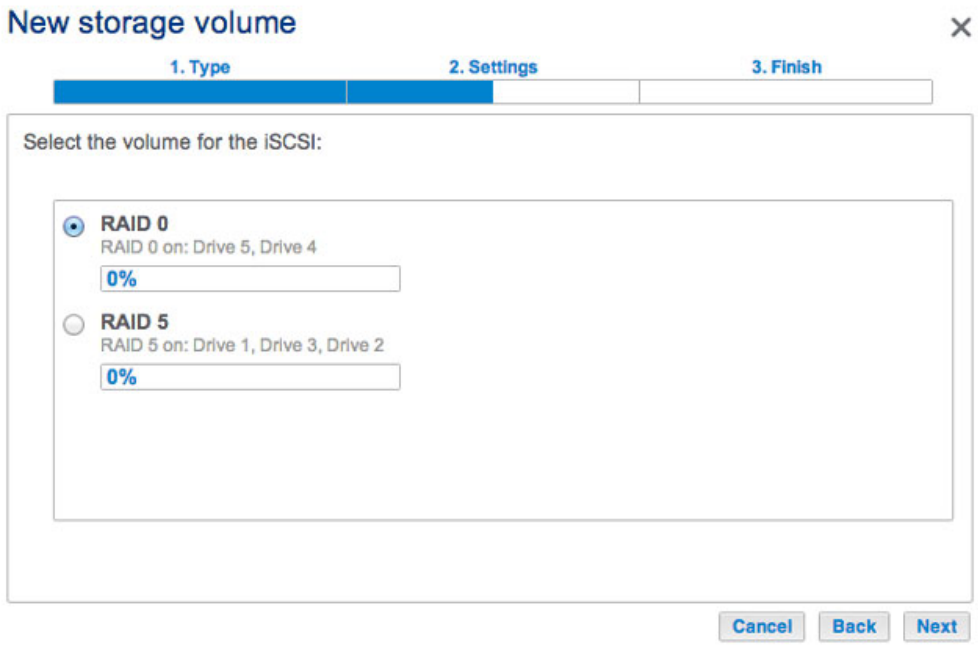

- 4. Drag the slider or enter a number to change the storage space allocated to the iSCSI target. After clicking on the slider, you have the option to press the right and left arrow keys on your keyboard to adjust the capacity. **Important:** Capacity allotted to an iSCSI target cannot be reallocated to the volume. The iSCSI target and its data must be deleted to recover the capacity.

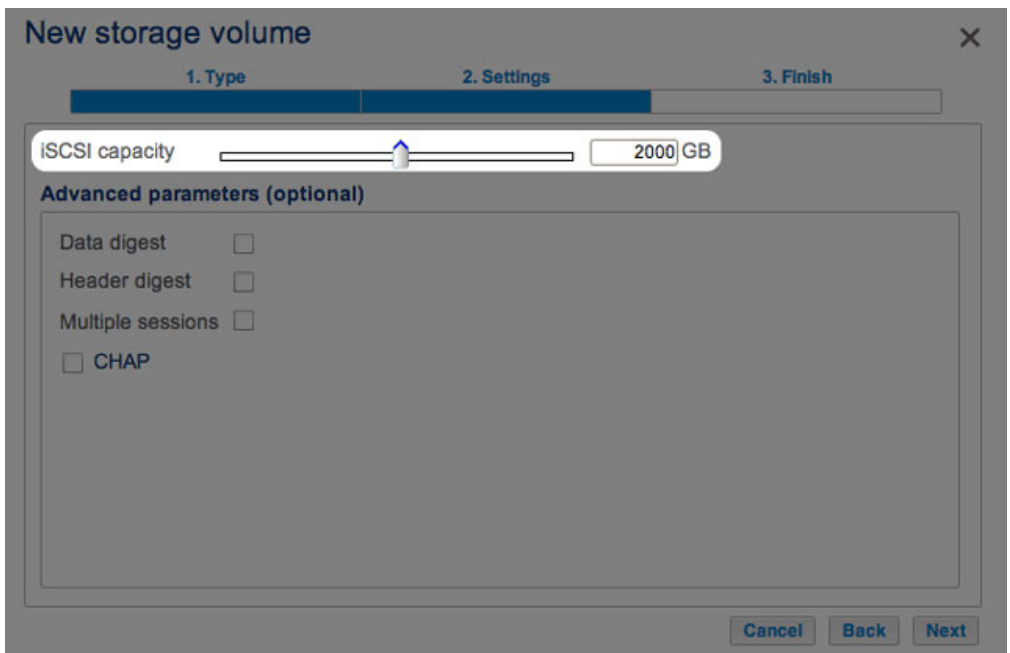

- 5. **Advanced parameters** offers the following options:

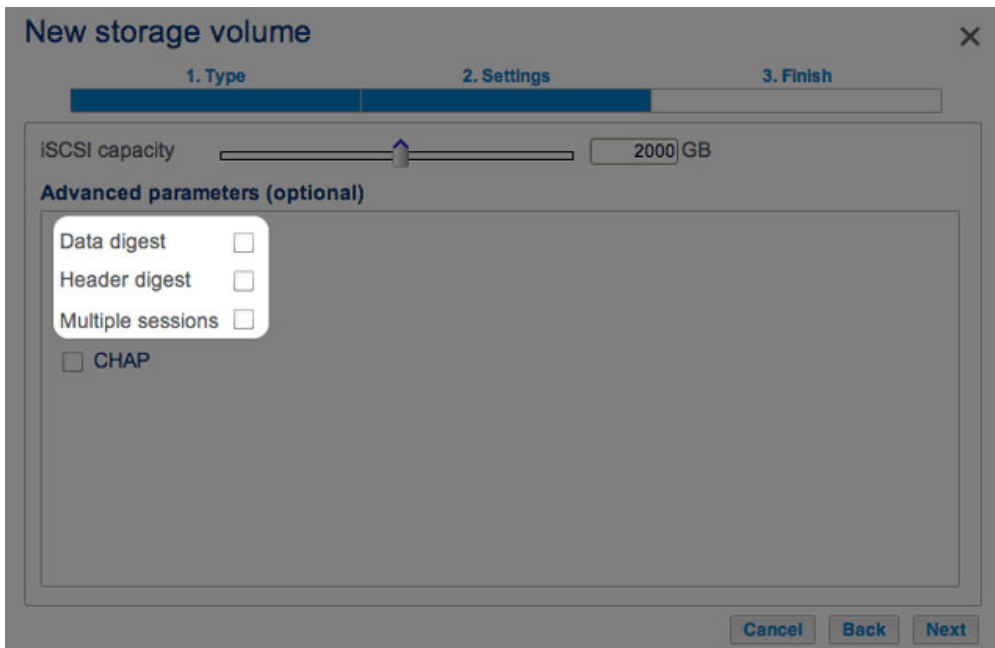

- Data digest: Enable checksum to verify the integrity of the SCSI Protocol Data Unit (PDU). Since it adds a step to the reading and writing of data, performance will be affected.
  - Header digest: Enable checksum to verify the integrity of the header portion of the SCSI PDU. Similar to Data digest, performance will be affected.
  - Multiple sessions: Select this option only if your iSCSI target will be managed within a SAN cluster environment. The SAN cluster allows multiple iSCSI initiators to access the iSCSI target at once.
6. Check the box next to **CHAP** within **Advanced parameters** to configure a password for the iSCSI target. CHAP (Challenge Handshake Authentication Protocol) will secure access to the iSCSI target via a password that is 12 to 16 characters. There are two levels of CHAP:

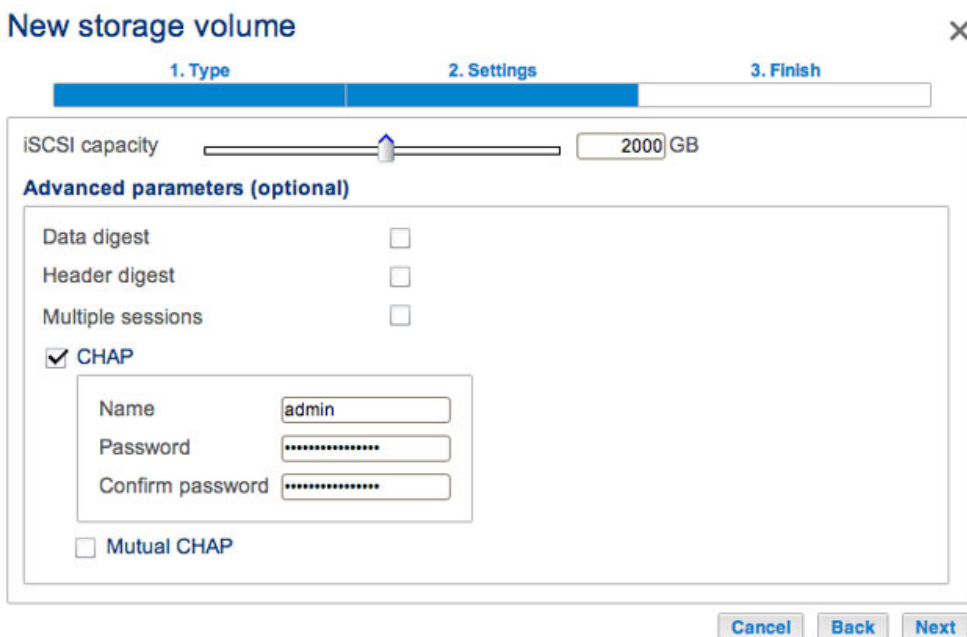

- CHAP: The iSCSI initiator must enter a name and a password to connect to the iSCSI target. This is also referred to as a *Secret* or *Target secret*.
- Mutual CHAP: Both the iSCSI target and the iSCSI initiator authenticate each other. Select this box to enter the name and password configured on the iSCSI initiator that will access the LaCie NAS's iSCSI target.

- 7. Choose **Next**.
- 8. Review the summary for the iSCSI target and choose **Finish**.

### New storage volume ✕

1. Type                      2. Settings                      3. Finish

---

Click Finish to confirm your selection.

Volume	RAID 0
Capacity	2 TB
Data digest	Disabled
Header digest	Disabled
Multiple sessions	Disabled
CHAP	Enabled
Mutual CHAP	Disabled

You must format the iSCSI with your OS disk utility.

## Dashboard: iSCSI target connection indicator

The Storage page provides the iSCSI target status:

- Not connected: The circle next to *Connected* is white.

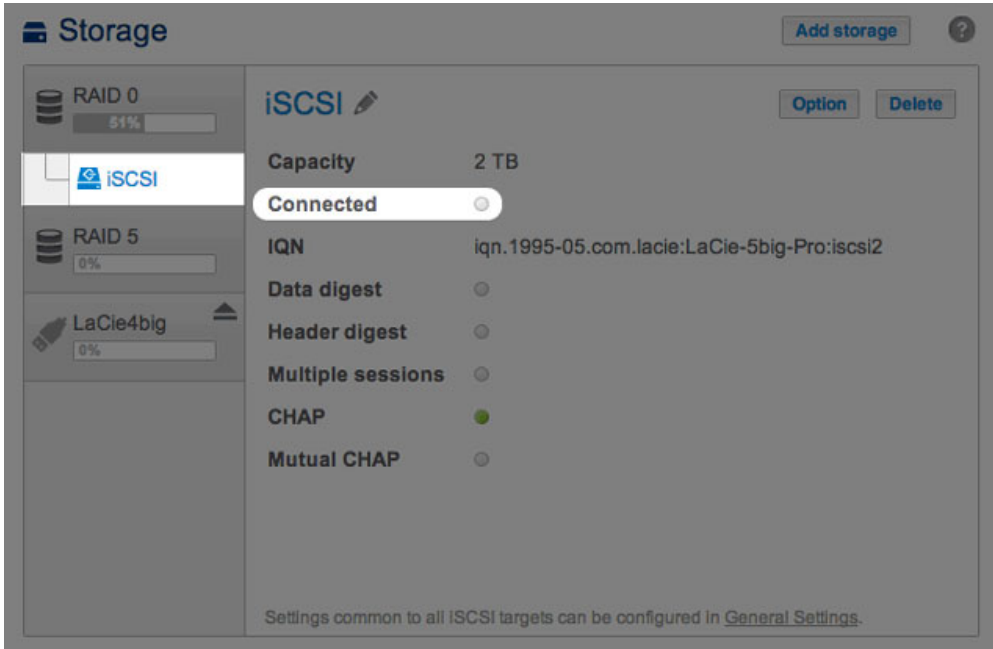

- Connected: The circle next to *Connected* is green.

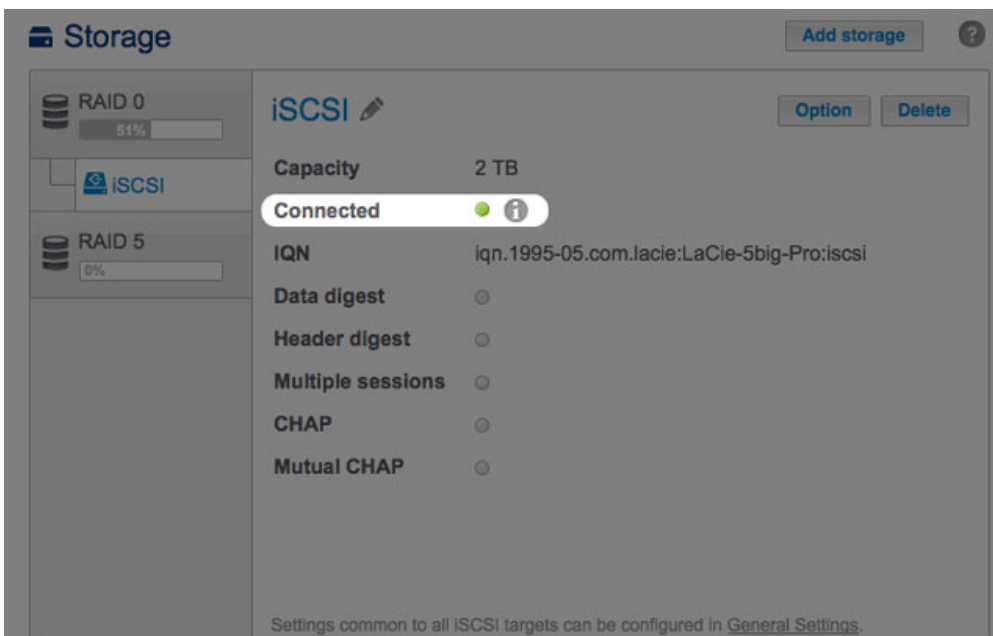

Choose the *i* tooltip next to the green circle to view the IP address of the workstation that has connected to the iSCSI target.



**Storage** Add storage ?

**RAID 0** 51%

**RAID 5** 0%

**iSCSI** Option Delete

**Capacity** 2 TB

**Connected** ● i

**IQN** iqn.1995-05.com.lacie:LaCie-5big-Pro:iscsi

**Data digest**

**Header digest**

**List of connected clients** ×

IP address	IQN
10.21.57.41	iqn.1991-05.com.microsoft:lacie-w7

Settings common to all iSCSI targets can be configured in [General Settings](#).

## Dashboard: Revise iSCSI Advanced parameters

Advanced parameters for an iSCSI target may be changed following its creation.

1. Go to **Dashboard > Storage** and choose the iSCSI target on the left.
2. Choose **Option**.

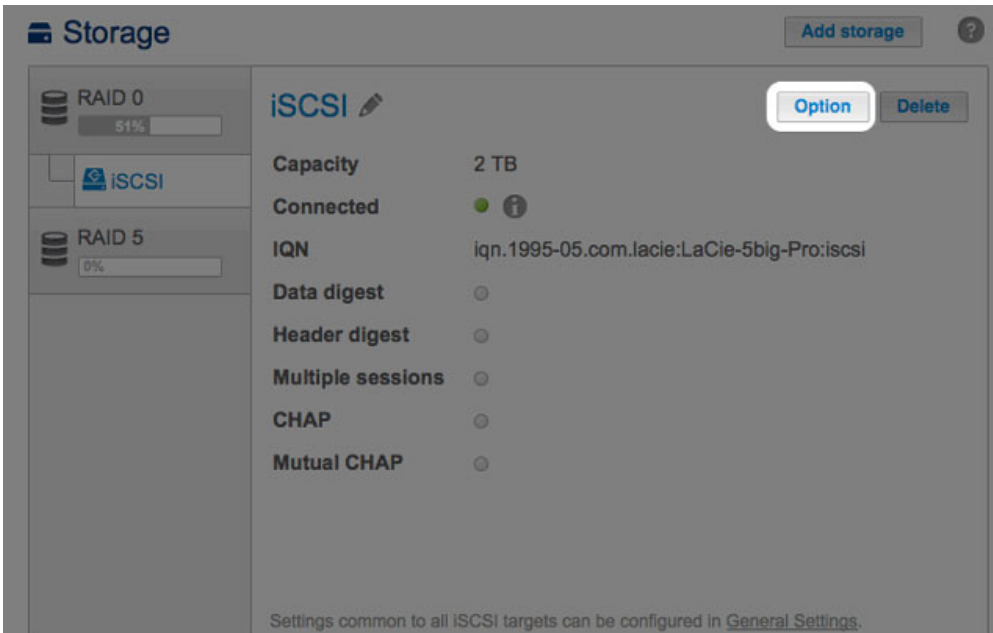

3. Adjust the parameters for the iSCSI target.

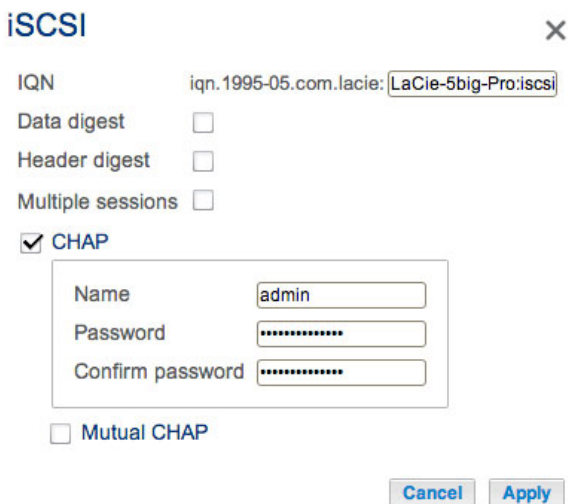

To review the definitions of the parameters, see [Create an iSCSI target](#).

*IQN* stands for iSCSI Qualified Name. The IQN field represents the:

- Type
- Date that the network naming authority took ownership of the iSCSI target and the network naming authority
- Prefix for the naming authority

The *Option* window allows you to revise the prefix for the naming authority.

**Technical note on changing parameters:** It is recommended that the iSCSI initiator disconnects from the iSCSI target before selecting **Option** to revise advanced parameters. Certain changes may not take effect until the iSCSI target reconnects to the initiator.

## iSCSI INITIATOR

A workstation on the network can connect to the LaCie NAS's iSCSI target by acting as an iSCSI initiator. While it is not possible to list the directions on how to become an iSCSI initiator for every operating system or third-party application, you should note the following:

- Windows: Professional and enterprise versions of Windows Vista, Windows 7, and Windows 8 feature an **iSCSI Initiator** application. Windows XP users can download the iSCSI Initiator [here](#). See the configuration example below.
- Mac: Third-party applications are available to connect to an iSCSI target.

### iSCSI initiator: Example

The steps below demonstrate a single connection to an iSCSI target using a Windows 7 workstation as the initiator. For the example, a CHAP has been configured on the iSCSI target only. Configurations will vary but you can review the instructions below and make adjustments for your operating system and network.

1. Search for and launch **iSCSI Initiator** or equivalent.
2. Enter the network name or IP address of the server that hosts the iSCSI target. In this example, the LaCie NAS.

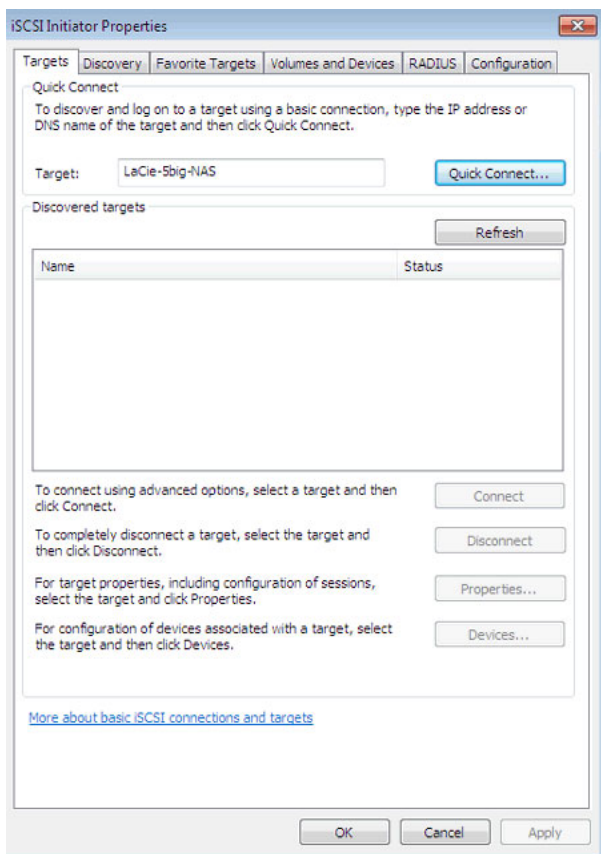

3. Choose **Quick connect** or equivalent.
4. Without and with CHAP:
  - If the iSCSI target does not include a CHAP, you will connect immediately. If it is the first time that the iSCSI target has connected to an initiator, you will be prompted to format the disk.
  - If the iSCSI target includes a CHAP, a prompt alerts you that a connection is not possible. Close the prompt.

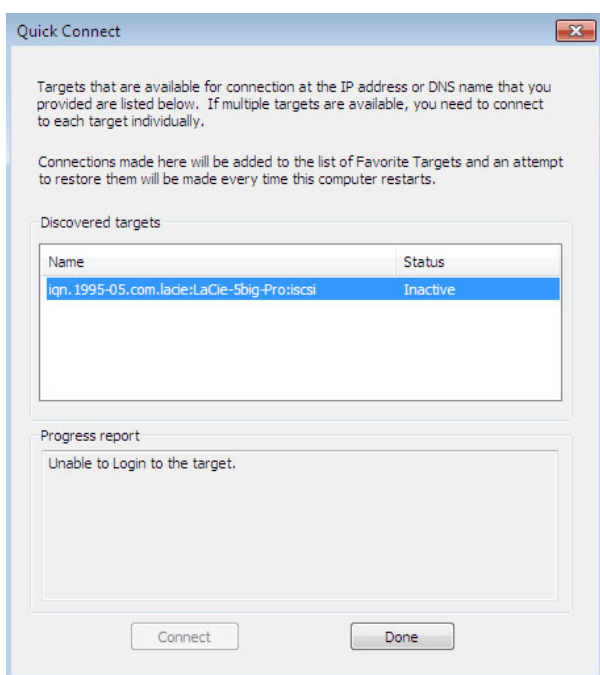

5. Select the LaCie NAS's iSCSI target in the list of discovered agents and choose **Connect**.

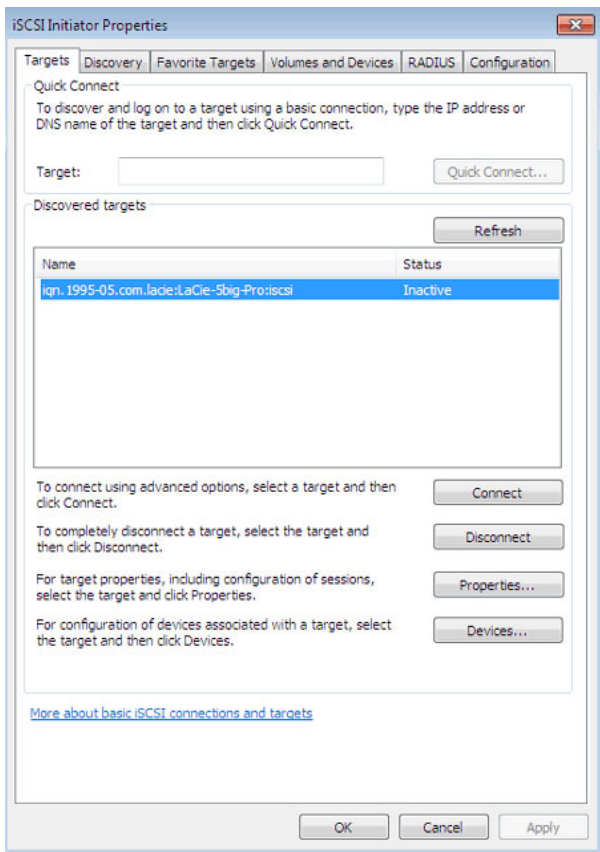

6. Choose **Advanced**.

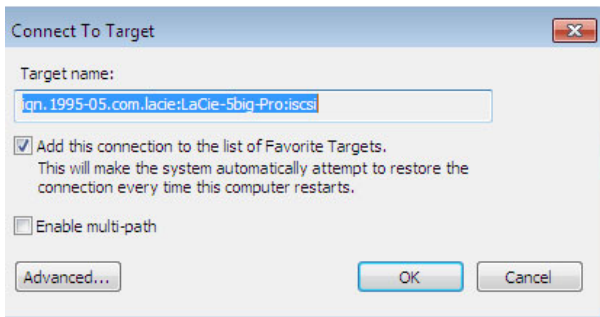

7. Select **Enable CHAP log on** and enter the **Name** and **Target secret** (password) for the iSCSI target.

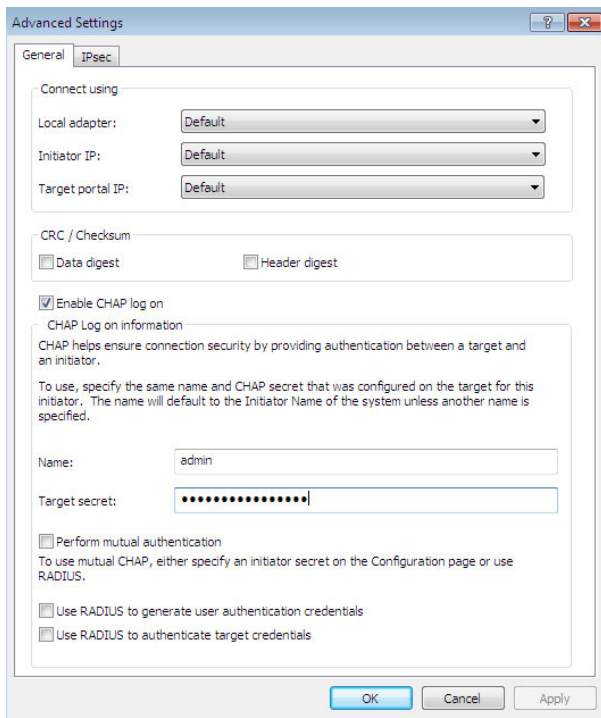

8. A window may appear prompting you to add the target to your favorites. Make your selection and exit.
9. If it is the first time that the iSCSI target has connected to an initiator, you will be prompted to format the disk.

The iSCSI target will appear in **Computer/My Computer** as a local disk.

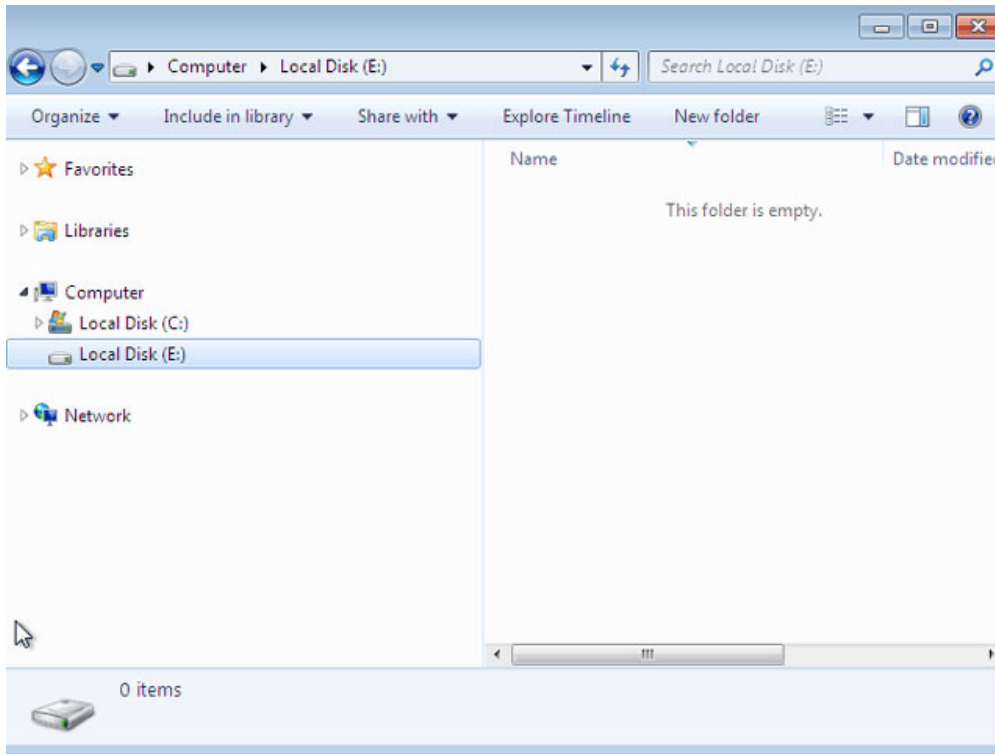

## ISNS: INTERNET STORAGE NAME SERVICE

A LaCie NAS iSCSI target can be managed by a server that supports the Internet Storage Name Service (iSNS). Certain iterations of Windows Server include the iSNS feature. A server that supports iSNS can manage multiple iSCSI targets on the network, thus saving time for each iSCSI initiator. For example, rather than searching the network for an iSCSI target, the initiator can look for a connection in a single location, the iSNS server. The iSNS server keeps tabs on all the iSCSI targets on the network, thus allowing the initiator to connect to one that is available.

Configure iSNS on your network server then review the instructions below to add your LaCie NAS iSCSI target.

### iSNS: LaCie NAS Dashboard (iSCSI target)

Enable iSNS server and enter its IP address:

1. Go to **Dashboard > General Settings > File sharing**.
2. Select the configuration icon (pencil) for **iSCSI** and then **Advanced parameters**.
3. Choose the checkbox and enter the iSNS server's IP address.

General Settings

- General
- File sharing
- Application services

Configure the settings for file sharing services on your device. [Show summary](#)

Name	Description	Status
SMB	Server Message Block. File and print sharing are native to Windows. They are also compatible with Linux and Mac OS X.	<span style="color: green;">●</span>
AFP	Apple Filing Protocol. File and print sharing native to Mac OS X.	<span style="color: green;">●</span>
NFS	Network File System. File sharing native to UNIX and Linux.	<span style="color: grey;">●</span>
FTP	File Transfer Protocol. Upload and download files locally and remotely.	<span style="color: green;">●</span>
SFTP	Secure File Transfer Protocol. Upload and download files locally or remotely using a secure connection.	<span style="color: grey;">●</span>
iSCSI	Block-level protocol for a single user, a SAN, or a cluster environment.	<span style="color: green;">●</span>

**iSCSI - Advanced parameters**

iSNS server  192.168.8.121

Available on: All LANs

**Important info regarding iSCSI volume sharing:** Mounting an iSCSI volume on multiple workstations at the same time will lead to serious file corruption. An exception can be found with SAN cluster environments that include servers and software dedicated to managing iSCSI volume sharing. An iSNS server is not considered to be a SAN cluster environment.



## iSNS: Workstation (iSCSI initiator)

The steps below demonstrate a single connection to an iSNS server using a Windows 7 workstation as the initiator. Configurations will vary but you can review the instructions below and make adjustments for your operating system and network.

1. Search for and launch **iSCSI Initiator** or equivalent.
2. Choose Discovery and **Add server**.

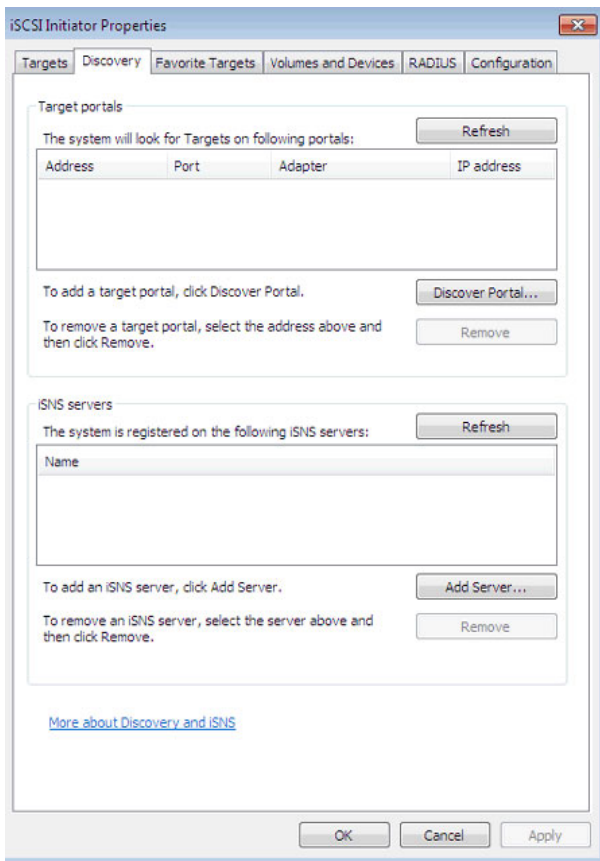

3. Enter the IP address of the iSNS server.

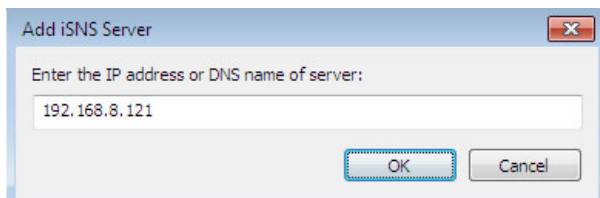

4. The list of discovered targets should show all iSCSI targets that are connected to the iSNS server. In this example, only the LaCie NAS is connected.

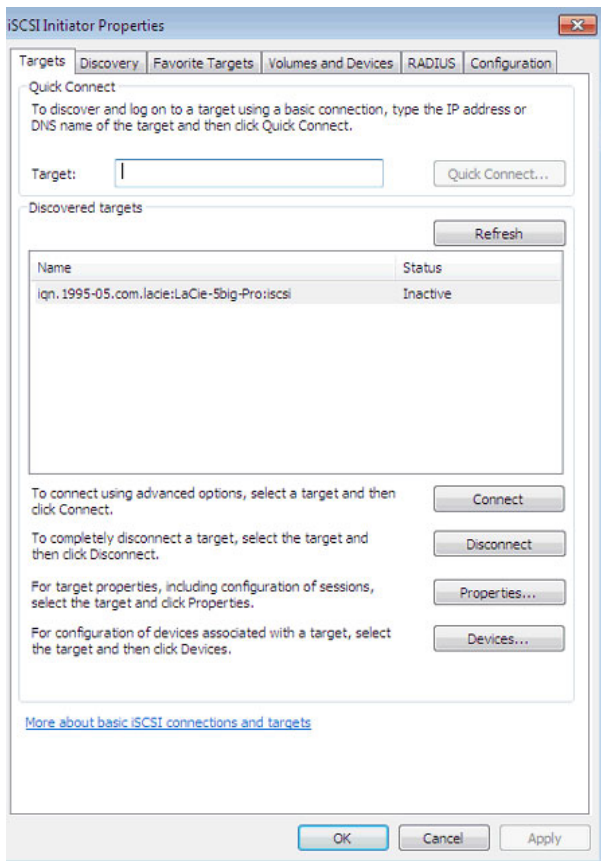

5. To connect to the iSCSI target, follow the instructions in [iSCSI initiator: Example](#).

# BACKUP JOBS

The Backup page features a **Backup & Restore Wizard** to help you create a backup job. Types of backup jobs include:

- **Local (Direct-attached storage (DAS)):**
  - Option 1: *Share A* on a LaCie NAS to an external hard drive (DAS) connected to one of the LaCie NAS's external ports. Each iteration of a backup job has a specific date and time giving you the flexibility to restore earlier versions of files. This can be helpful if someone has mistakenly deleted or made revisions to a document and you want to recover an earlier version.
  - Option 2: Connect a DAS to one of your LaCie NAS's ports to back up the DAS's files to a share.
- **Remote network (local network):** A share on the LaCie NAS to a share on a second LaCie NAS or rsync-compatible NAS on your local network. For example, *Share A* on the LaCie 5big NAS Pro in your office to a LaCie 2big NAS in your colleague's office.
- **Remote network (offsite):** A share on the LaCie NAS to a share on a second LaCie NAS or rsync-compatible NAS outside of your local network. For example, *Share A* on your LaCie 2big NAS in your home office to a LaCie 5big NAS Pro at a colleague's home office.
- **Restore:** Restore a backup job from your DAS to the LaCie NAS or, the LaCie NAS to the DAS.

**Note on backup jobs:** To conserve processing resources, NAS OS runs one backup job at a time. If more than one job is scheduled for the same time or started manually, the backup page will place them in a queue.

## BACKUP EXAMPLES

*Remote (local network):* To prevent data loss due to hardware failure, you schedule regular backups of a LaCie 2big NAS to a LaCie 5big NAS Pro. They are both on the same local network. See [Remote Backup: Rsync](#) for details on how to back up data to non-LaCie servers that are rsync-compatible.

*Remote (offsite):* To prevent data loss due to onsite fire, flood, or theft, you back up folders on a LaCie 5big NAS Pro in your company's headquarters to a LaCie 5big NAS Pro at a branch office. You can use the Backup page to set up a remote backup to a LaCie NAS at another location (offsite). See [Remote Backup: Offsite](#) for details on how to back up to an offsite NAS.

*Restore:* Someone in the office accidentally deleted an important spreadsheet from his personal share. Fortunately, the administrator backed up the user's share every night onto the DAS connected to the 2big NAS. The administrator can:

- Create a Restore job to revert the share to an earlier state (see [Restore a Local Backup](#) for details on how to restore data to or from a DAS).
- Connect the DAS to a computer and browse for the missing file.

**Important info:** The time to complete the first backup job will vary based upon the amount of data and the speed of your network. It can take several hours or, if it is an offsite backups, several days.

# CREATE A LOCAL BACKUP (DAS)

Connect an external hard drive (direct-attached storage or, DAS) to one of the NAS's USB or eSATA ports before following the steps below (see [Views of the Product](#) for port locations). The DAS should appear as a volume on the Storage page [LaCie NAS Ports and Direct-Attached Storage](#)

1. Go to **Dashboard > Backup**.
2. Choose **Add backup**.

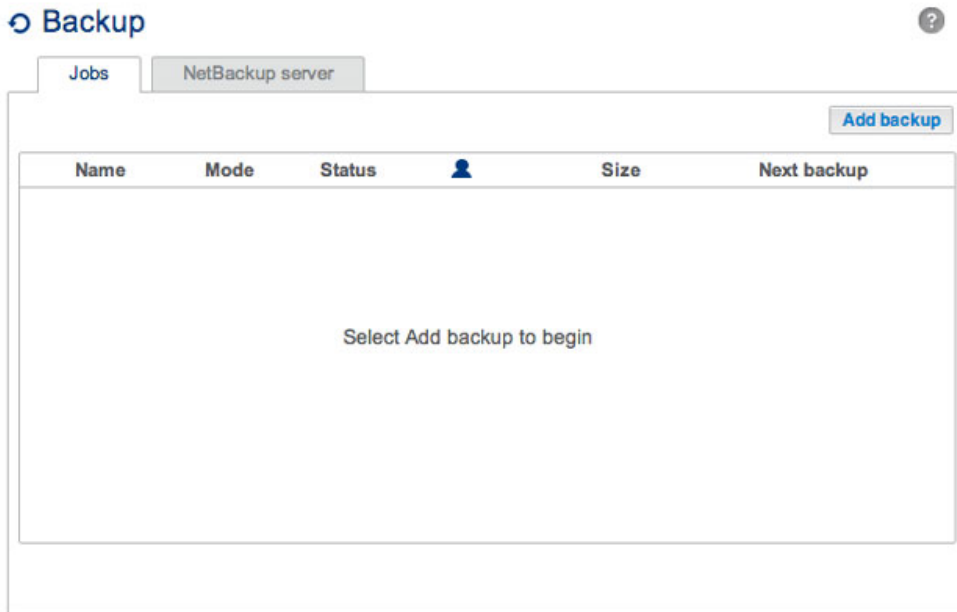

3. Select **Local backup** then choose **Next**.

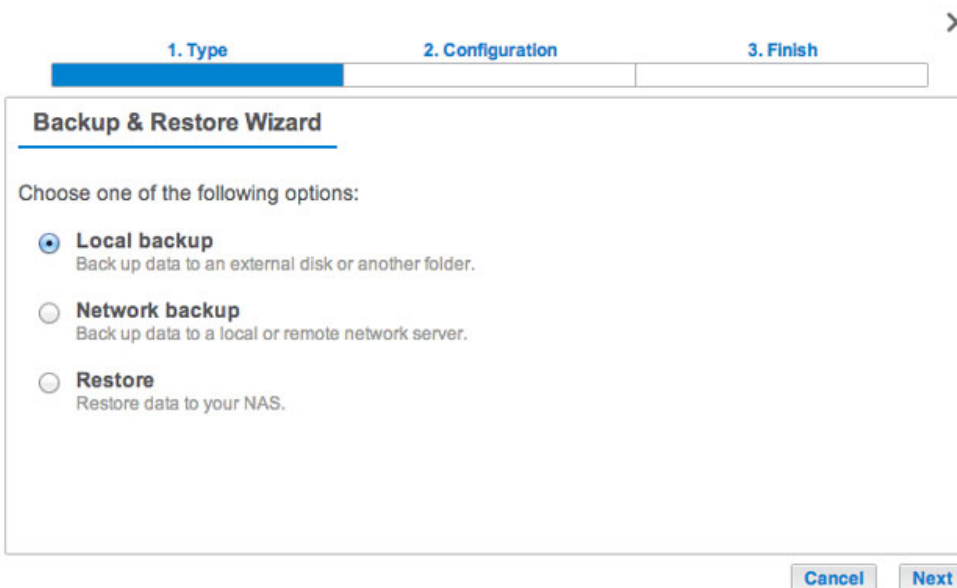

4. Under **Source** on the left, select the NAS shares or DAS partitions to back up. Under **Destination** on the right, select the *External ports* or NAS share to store the backup job.

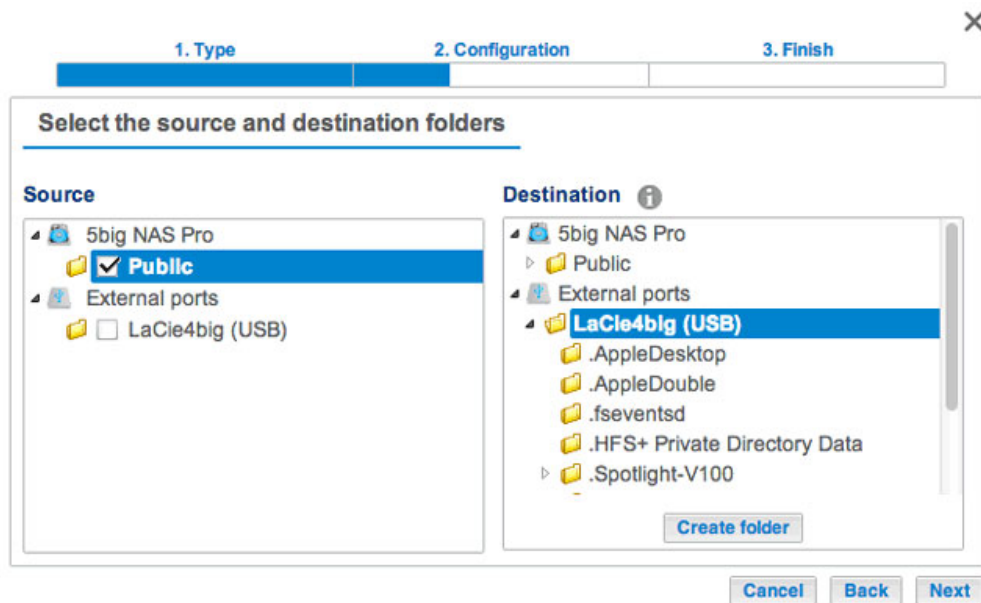

5. To better organize backup jobs, you can create a folder inside the destination. Choose **Create folder** then enter its name. Choose **Create** then **Next**.



6. Select a backup type, then choose **Next**.

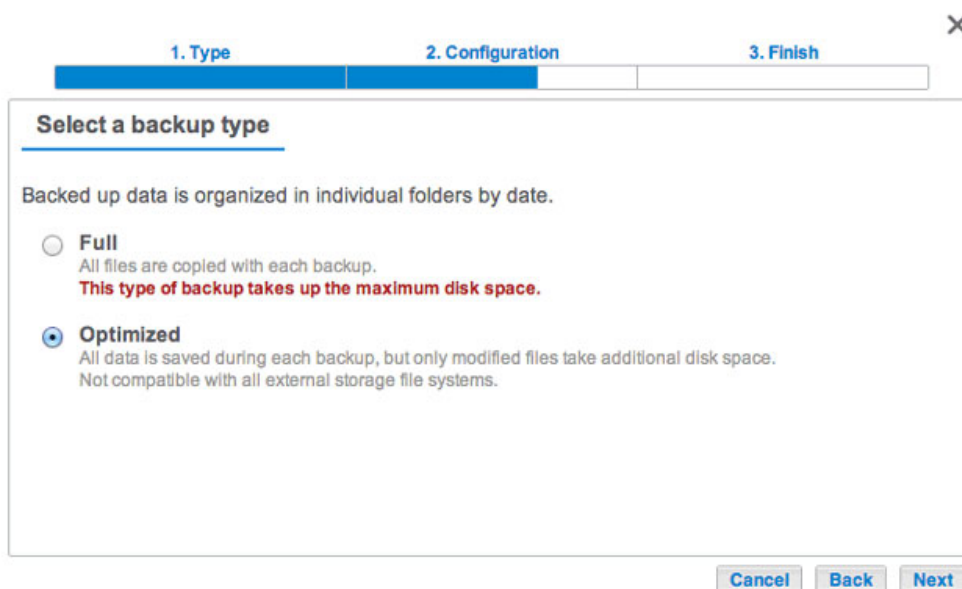

- **Full:** The entire contents of the source folder will be saved each time the backup job runs. This method offers high security but it requires a good amount of storage capacity on the destination.
  - **Optimized** After the initial full backup, only modified files are added in subsequent backups. This is an efficient use of storage space on the destination. Important: **Optimized backups are not available with certain DAS file systems.** See [Supported File Systems for Optimized Backups](#).
7. Select **Manual**, **Scheduled**, or **Custom** then choose **Next**. See note regarding Manual backups.

- (Skip this step if you chose *Manual*.) Select the frequency for your backup job and the time of day. Choose **Next**.
- Enter a name for the backup job then choose **Next**.

1. Type      2. Configuration      3. Finish

**Choose a backup name**

Name your backup job:

Cancel   Back   Next

- Confirm the backup settings on the *Summary* page. If you wish to begin the backup immediately, keep the box checked below the summary and choose **Finish**.

1. Type      2. Configuration      3. Finish

**Summary**

Confirm your settings and click Finish.

Job	LaCie-5bigNASPro
Type	Local backup - Optimized
Mode	Scheduled
Schedule	Monthly, Last day of the month at 23:00
Source	Public
Destination	LaCie4big (USB)/BU5bigNASPro

Select this option to begin the backup after you click Finish.

Cancel   Back   Finish

The backup job will appear on **Dashboard > Backup**.

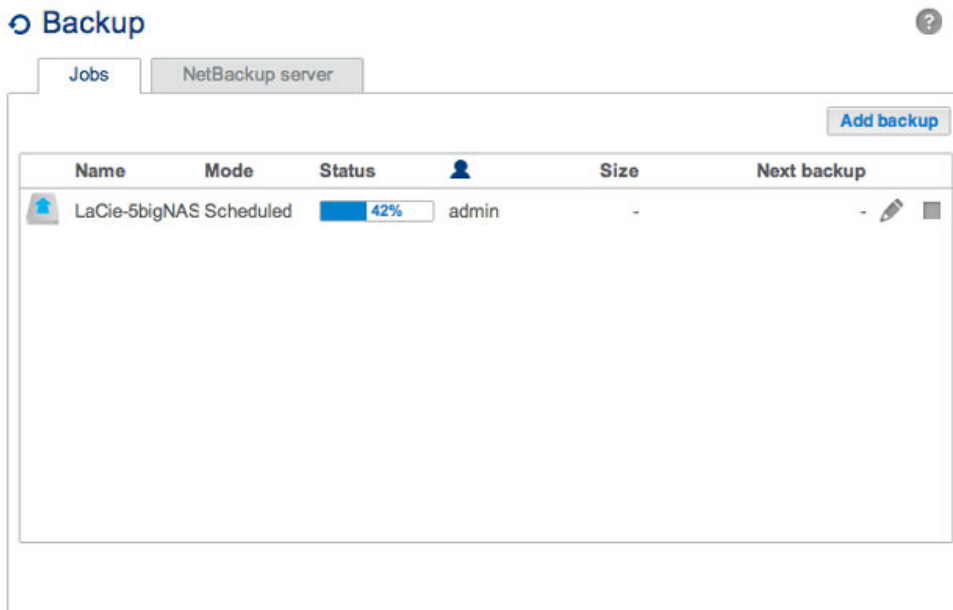

**Note on Manual Backups:** A manual backup must be started by the administrator:

1. Navigate to **Dashboard > Backup**.
2. Locate the manual backup job you wish to start then click on its grey arrow icon on the far right.

## SUPPORTED FILE SYSTEMS FOR OPTIMIZED BACKUPS

Operating Systems	Hard Disk File System	Optimized Backup (Incremental)
Linux	ext2, ext3, ext4, and XFS	Yes
Mac	HFS+ Non-Journaled	Yes
Mac	HFS+ Journaled	No
Windows/Mac	FAT32	No
Windows	NTFS	No



# REMOTE BACKUPS: ENABLE NETBACKUP SERVER

Remote backups copy data from a share on your LaCie NAS to a share on a second NAS. A second NAS can be another LaCie NAS running LaCie NAS OS (see [LaCie Network Storage](#) for details). It can also be a non-LaCie NAS compatible with rsync.

The share that you back up on your LaCie NAS is the *Source*. The second NAS is the *Destination* that stores the backup.

Source NAS	Destination NAS	Destination NAS Location	Destination share	Type of Remote Backup
LaCie NAS A on the local network	LaCie NAS B or a third-party rsync-compatible NAS	Local network	NetBackup Share or rsync equivalent	Local NAS-to-NAS
LaCie NAS A on the local network	LaCie NAS B or a third-party rsync compatible NAS	Network outside of the local network (e.g. a colleague's home or a branch office)	NetBackup Share or rsync equivalent	Offsite NAS-to-NAS

**Note on rsync:** See [Remote Backup: Rsync](#) for instructions on how to back up to to a non-LaCie NAS that is rsync compatible.

## ENABLE NETBACKUP SHARE

All remote backups from a LaCie NAS to a second LaCie NAS are copied to a special share called *NetBackup*. The NetBackup share on the destination LaCie NAS must be enabled before creating a remote backup job.

Enable the NetBackup Share:

1. Launch the Dashboard for the **Destination LaCie NAS**.
2. Navigate to **Dashboard > Backup** and select the tab **NetBackup server**.

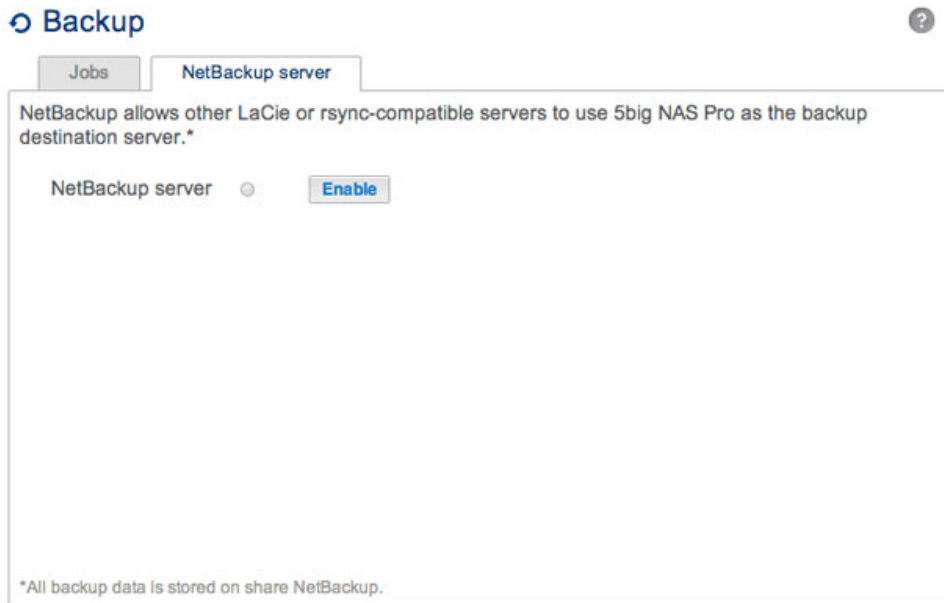

3. Choose **Enable**.
4. At the prompt, enter and confirm a password. The password can be different from the password you used for your Dashboard login. Your NetBackup password will be needed when you set up a Remote backup.

**Enable NetBackup server** ✕

Password  ⓘ

Confirm password

Location  ⌵

5. If you have more than one volume, select the **Location** pull-down menu to choose a volume for the NetBackup share. It is highly recommended that you use a volume with RAID protection (RAID 1, RAID 5, or RAID 6).

**Enable NetBackup server** ✕

Password  i

Confirm password

Location   
 RAID 0 (Available: 3.9 TB)   
 RAID 5 (Available: 3.9 TB)

6. Choose **Apply**.

**Enable NetBackup server** ✕

Password  i

Confirm password

Location  ▾

7. With NetBackup enabled, the Dashboard provides a summary of the settings. You can return to this page if you forget the password or you want to disable the NetBackup share.

**Backup** ?

NetBackup allows other LaCie or rsync-compatible servers to use 5big NAS Pro as the backup destination server.\*

NetBackup server ●

Settings:

NAS name	LaCie-5big-Pro
Login	netbackup
Password	***** <span>✎</span> <span>🔍</span>
Port	22
Port	873 (for encrypted backups)

\*All backup data is stored on share NetBackup.

## NetBackup tab

- The NetBackup Share can only be accessed by the administrator of the LaCie NAS.
- The administrator can find the NetBackup password if it is forgotten. Go to the NetBackup tab and click on the magnifying glass icon.
- To change the NetBackup password, choose the configuration icon (pencil).

# REMOTE BACKUP: LOCAL NETWORK

Before following the instructions below, please make certain that:

- The Destination NAS is connected to the same network as your source LaCie NAS and that both devices are powered on.
  - The NetBackup share has been enabled on the destination LaCie NAS.
1. Go to **Dashboard > Backup**.
  2. Choose **Add backup** to launch the Backup & Restore Wizard.

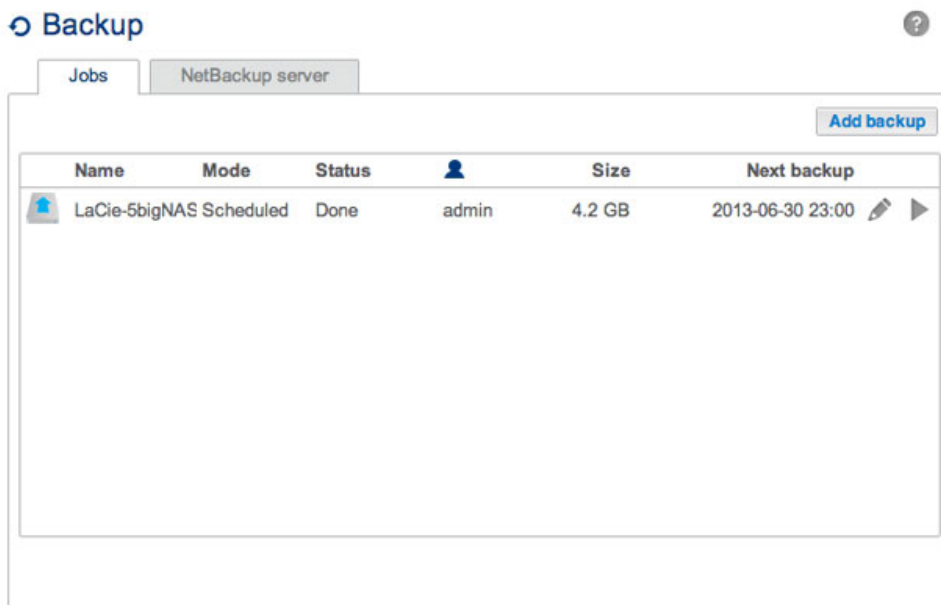

3. Select **Network backup** and choose **Next**.

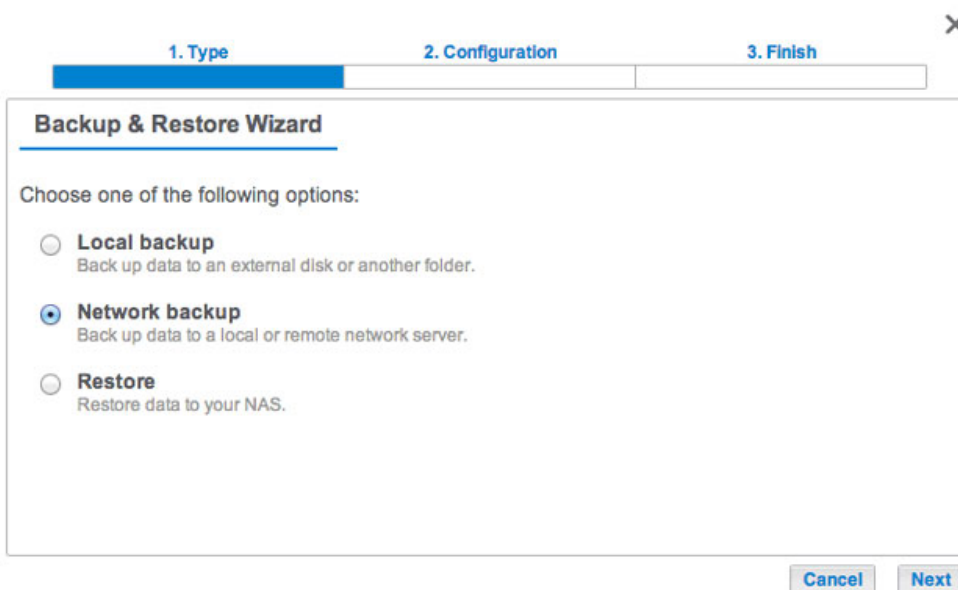

4. Select the share(s) you want to back up then choose **Next**.

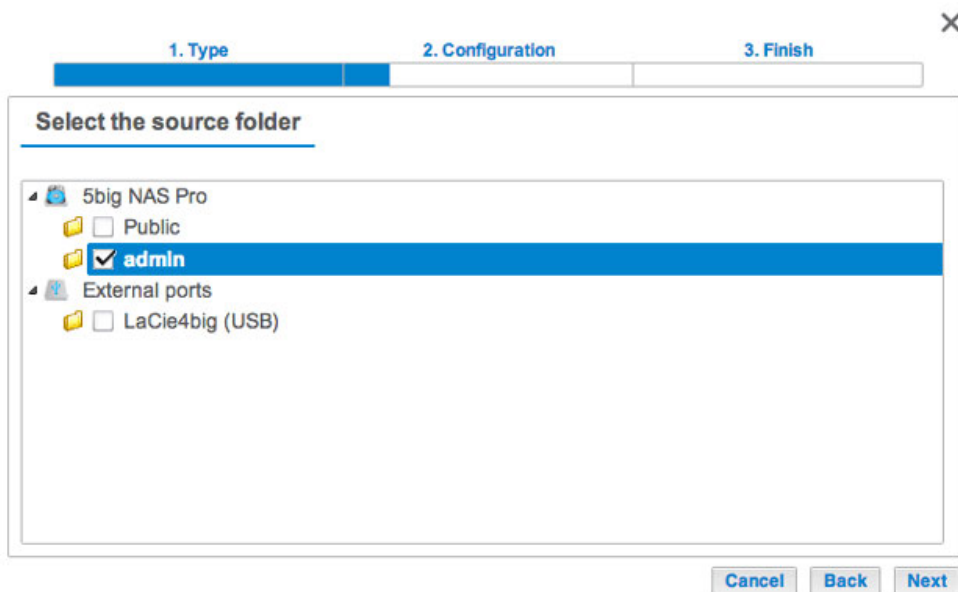

5. Select **LaCie NAS** to back up to another LaCie NAS then choose **Next** (see [Remote Backup: Rsync](#) for non-LaCie NAS).

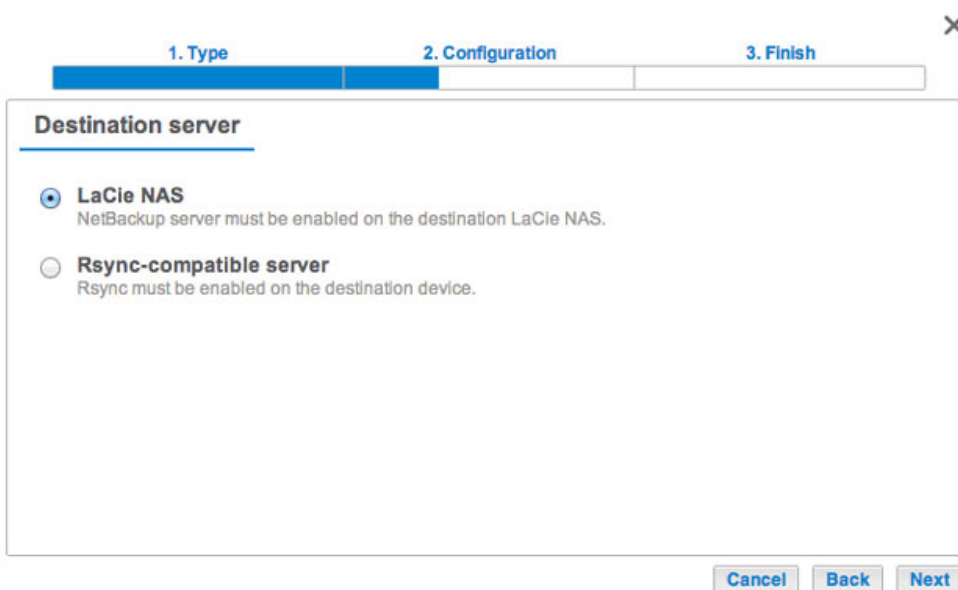

6. The wizard will search for and list compatible LaCie NAS on the local network. Choose the radio button next to the destination LaCie NAS and enter its NetBackup server password on the bottom of the window (see [Remote Backups: Enable NetBackup Server](#) for further information on the NetBackup server password). Choose **Next**.

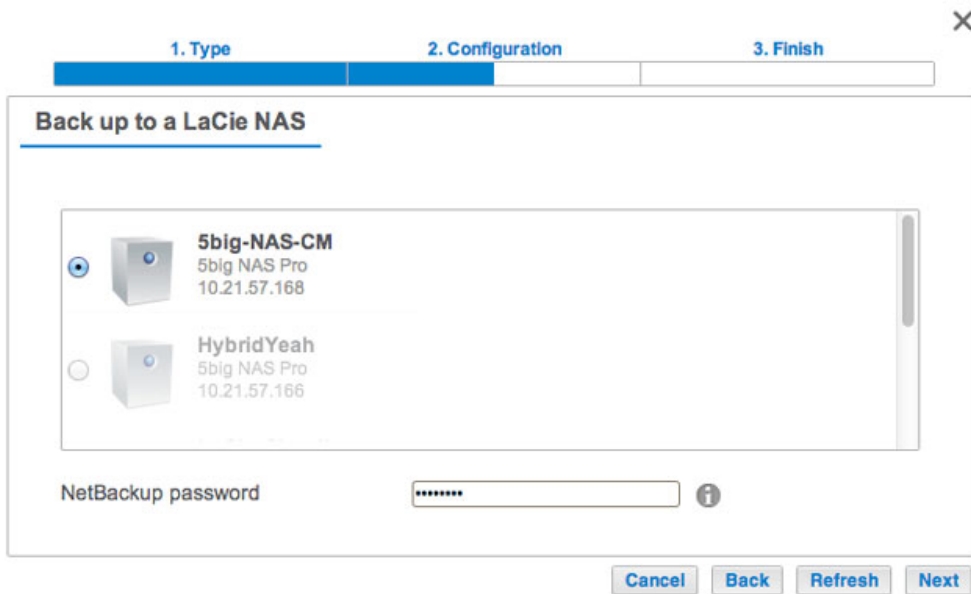

- If the LaCie NAS is listed but cannot be selected, you must enable NetBackup server. See [Remote Backups: Enable NetBackup Server](#).
  - If the LaCie NAS does not appear on the list, please make certain it is powered on and out of sleep mode (see [Eco Management](#)).
7. The Advanced parameters window lists four options for your backup job. See the explanations below. It is not mandatory to select one or more of the parameters to continue with the backup:

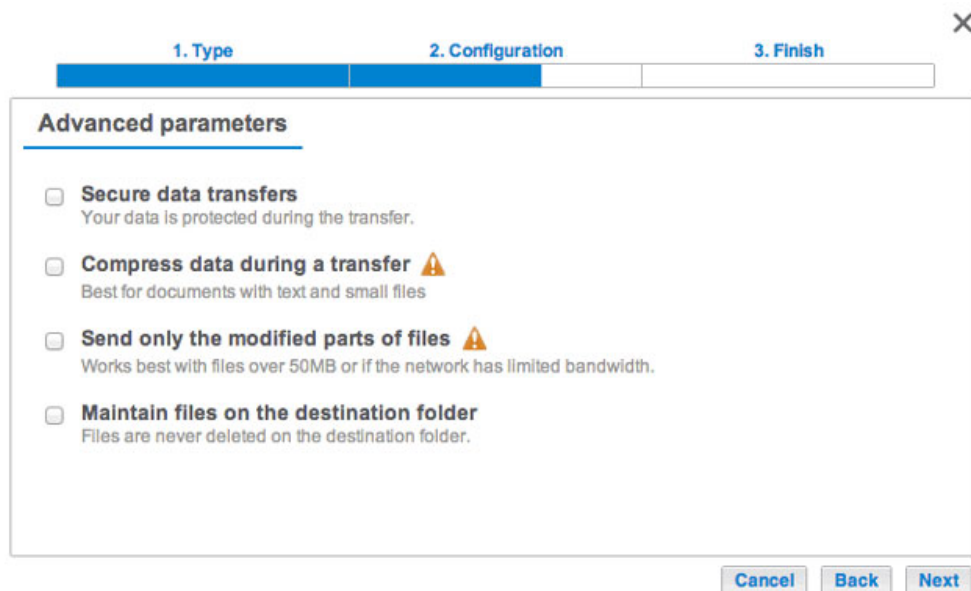

- *Secure data transfers* uses encryption during the data transfer. The data is not encrypted once it is stored on the destination NAS. This option is ideal for offsite backups.
- *Compressing data* optimizes data transmission rates. Data is compressed during the transfer only. While this option is good for low bandwidth networks, it can affect the NAS's performance.
- *Sending modified parts of files* is best used with backups that include files larger than 50MB. For example, if you edit a document that has already been backed up, only the edits will be copied during the next backup. This option can affect the NAS's performance.
- *Maintain files on the destination folder* keeps files on the destination NAS even if they are deleted from the

original NAS's source folder.

8. Choose **Next**.
9. Set the frequency for the backup.

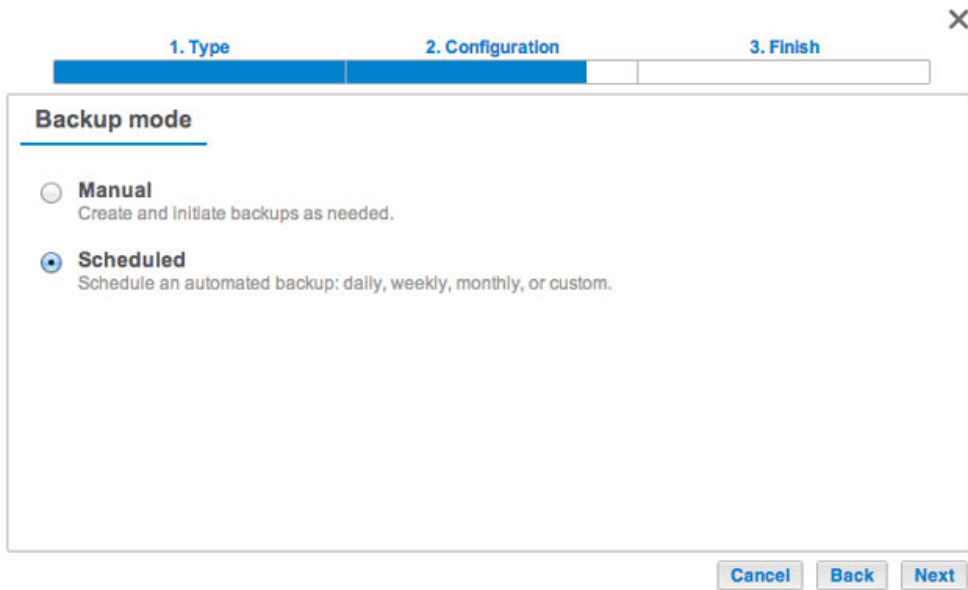

The screenshot shows a configuration window titled "Backup mode" with a close button (X) in the top right corner. At the top, there is a progress bar with three steps: "1. Type", "2. Configuration", and "3. Finish". The "2. Configuration" step is currently active. Below the progress bar, the "Backup mode" section has two radio button options: "Manual" (unselected) with the description "Create and initiate backups as needed.", and "Scheduled" (selected) with the description "Schedule an automated backup: daily, weekly, monthly, or custom.". At the bottom right of the window, there are three buttons: "Cancel", "Back", and "Next".

- *Manual*: You must initiate the backup.
- *Scheduled*: The backup will begin at the scheduled time.

10. Enter a name for the backup job then choose **Next**. The name will be listed on the Backup page job table. It is also the reference name for the backup job's folder on the destination volume.

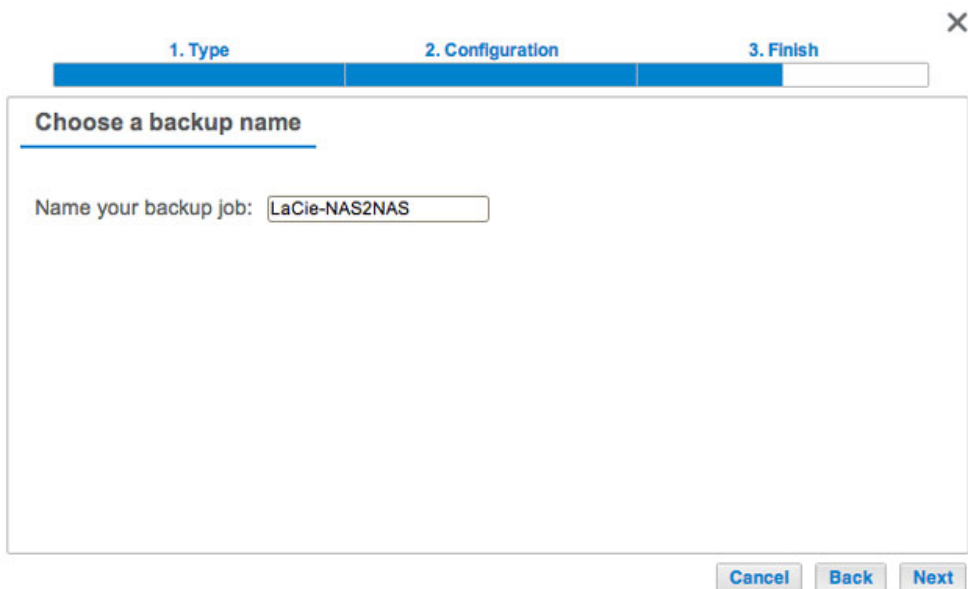

The screenshot shows a configuration window titled "Choose a backup name" with a close button (X) in the top right corner. At the top, there is a progress bar with three steps: "1. Type", "2. Configuration", and "3. Finish". The "2. Configuration" step is currently active. Below the progress bar, the "Choose a backup name" section has a text input field labeled "Name your backup job:" with the text "LaCie-NAS2NAS" entered. At the bottom right of the window, there are three buttons: "Cancel", "Back", and "Next".

11. Confirm the backup settings on the *Summary* page. If you wish to begin the backup immediately, keep the box checked below the summary and choose **Finish**.

✕

1. Type      2. Configuration      3. Finish

---

**Summary**

Confirm your settings and click Finish.

Job	LaCie-NAS2NAS
Type	Network backup - Mirror
Mode	Scheduled
Schedule	Daily, 23:00
Source	admin
Destination	5big-NAS-CM/NetBackup
Advanced parameters	Never delete files on the destination

Select this option to begin the backup after you click Finish.

The backup job will be listed on the Backup page.

**Backup** ?

Jobs    NetBackup server

Name	Mode	Status		Size	Next backup	
LaCie-5bigNAS	Scheduled	Done	admin	4.2 GB	2013-06-30 23:00	
LaCie-NAS2N <sup>A</sup>	Scheduled	Done	admin	2 GB	2013-06-27 23:00	

**Note on Manual Backups:** A manual backup must be started by the administrator:

1. Go to **Dashboard > Backup**.
2. Locate the manual backup job you wish to start then click on its grey arrow icon on the far right.



## REMOTE BACKUP: OFFSITE

Review the list of prerequisites for an offsite backup before following the instructions:

- The destination NAS must be connected to an offsite network and powered on.
- You must have the **public IP address** for the Destination NAS. You can find the public IP address by visiting <http://www.whatismyip.com/> or by accessing your router's management software. When searching for the public IP address, use a computer connected to the same router as the destination NAS. For further information, review the user manual for the offsite network router or contact your internet service provider. An explanation of IP addressing is available at [http://en.wikipedia.org/wiki/IP\\_address](http://en.wikipedia.org/wiki/IP_address).
- If you are using a LaCie NAS for the offsite backup, enable the NetBackup server (see [Remote Backups: Enable NetBackup Server](#)).

**Note on offsite backups:** If you have disabled port forwarding or you are experiencing difficulties connecting to the destination NAS, use the router's management software at the offsite location to open port numbers 22 and 873. Review the user manual for the offsite network router or contact your internet service provider.

## ADDING AN OFFSITE BACKUP

1. Go to **Dashboard > Backup**.
2. Choose **Add backup** to launch the Backup & Restore Wizard.

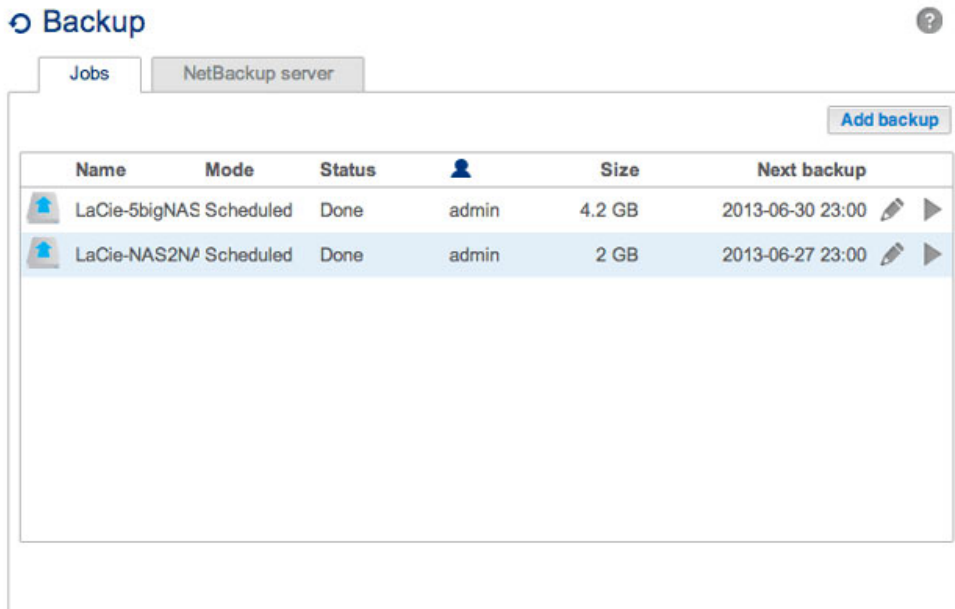

3. Select **Network backup** and choose **Next**.

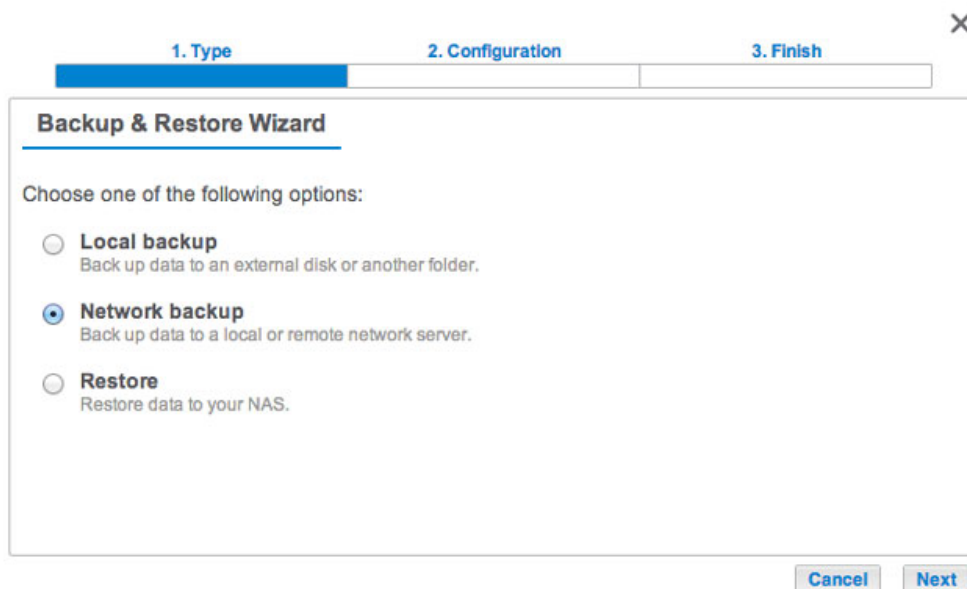

4. Select the share(s) you want to back up.

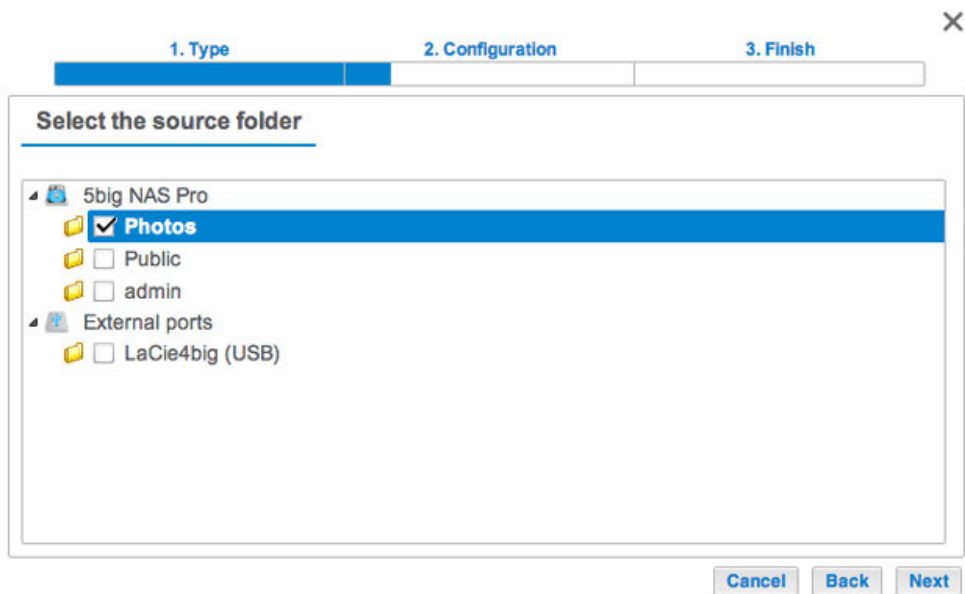

5. Select **LaCie NAS** to back up to another NAS OS device and choose **Next**.

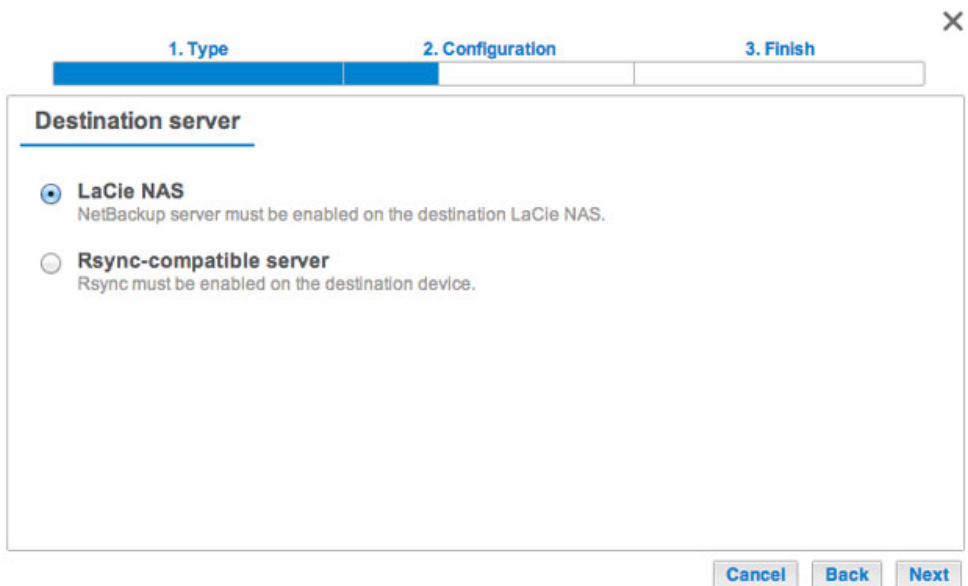

6. The wizard will search the local network for a LaCie NAS. You can select **Skip** to move to the next step.

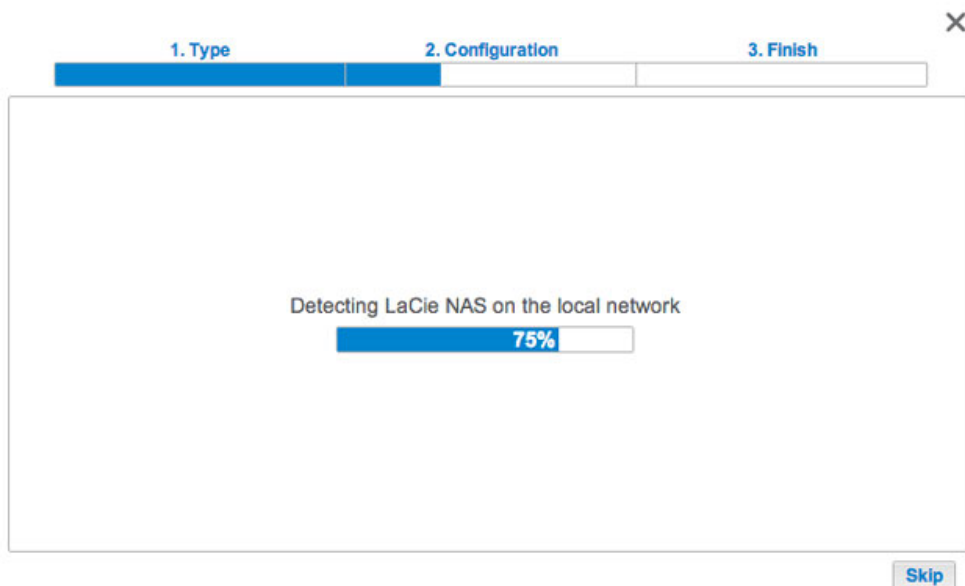

7. Choose **NAS name or IP address** then enter the destination NAS's public IP address. If you do not know the public address for the destination NAS, please refer to the offsite network router's documentation or contact the internet service provider. Select **Next** to continue.

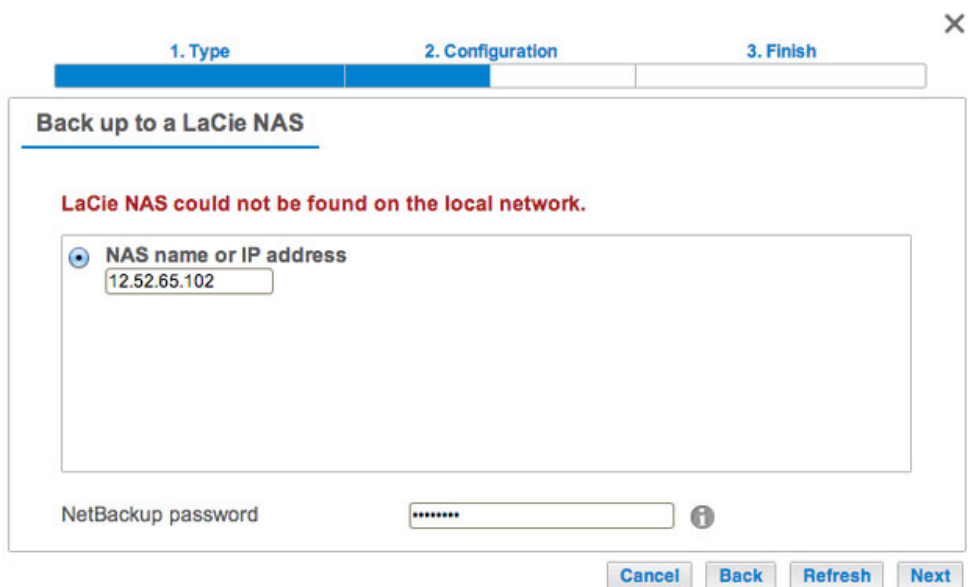

*Enter the destination NAS's public IP address*

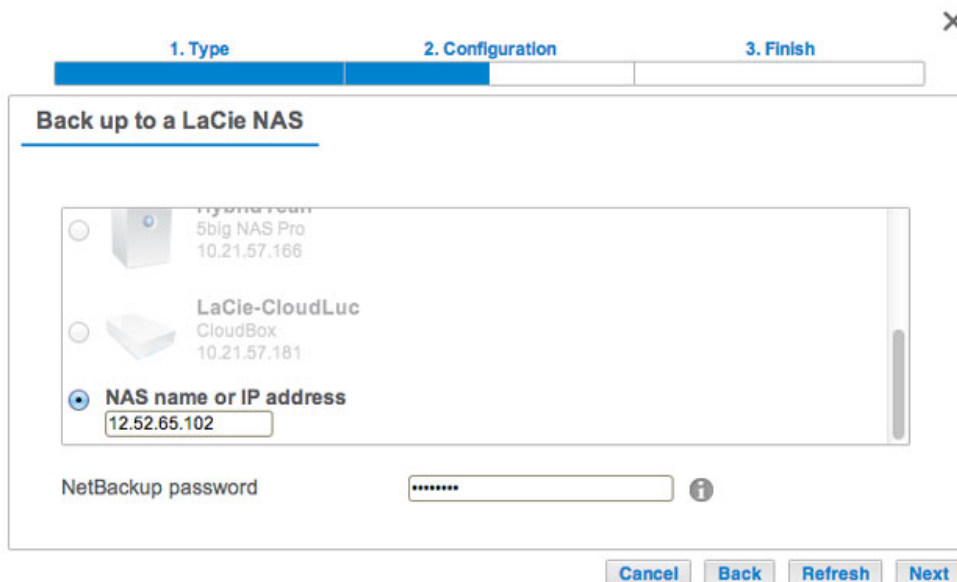

**For multiple NAS listings, scroll down to enter the destination NAS's public IP address**

8. The Backup & Restore Wizard will search for the offsite destination NAS. If the destination NAS cannot be found, please make certain that:
  - It is powered on and out of sleep mode (see [Eco Management](#)).
  - NetBackup server has been enabled (see [Remote Backups: Enable NetBackup Server](#)).
  - The proper IP address has been entered. You must use the public IP address rather than the IP address generated by the destination NAS's DHCP server.
9. The Advanced parameters window lists four options for your backup job. See the explanations below. It is not mandatory to select one or more of the parameters to continue with the backup:

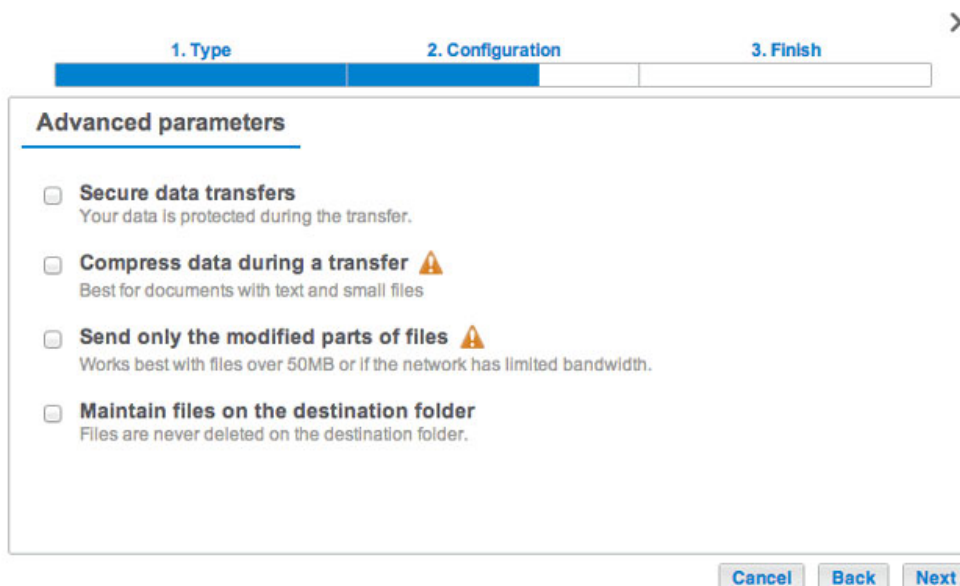

- *Secure data transfers* uses encryption during the data transfer. The data is not encrypted once it is stored on the destination NAS. This option is ideal for offsite backups.
- *Compressing data* optimizes data transmission rates. Data is compressed during the transfer only. While this option is good for low bandwidth networks, it can affect the NAS's performance.
- *Sending modified parts of files* is best used with backups that include files larger than 50MB. For example, if you edit a document that has already been backed up, only the edits will be copied during the next backup. This option can affect the NAS's performance.
- *Maintain files on the destination folder* keeps files on the destination NAS even if they are deleted from the

original NAS's source folder.

10. Choose **Next**.
11. Set the frequency for the backup.

1. Type      2. Configuration      3. Finish

**Backup mode**

**Manual**  
Create and initiate backups as needed.

**Scheduled**  
Schedule an automated backup: daily, weekly, monthly, or custom.

Cancel   Back   Next

- *Manual*: You must initiate the backup job. See the note below.
- *Scheduled*: The backup job will begin at the scheduled time.

12. Enter a name for the backup job then choose **Next**.

1. Type      2. Configuration      3. Finish

**Choose a backup name**

Name your backup job:

Cancel   Back   Next

13. Confirm the backup settings on the *Summary* page. If you wish to begin the backup immediately, keep the box checked below the summary and choose **Finish**.

✕

1. Type      2. Configuration      3. Finish

---

**Summary**

Confirm your settings and click Finish.

Job	LaCie-Offsite
Type	Network backup - Mirror
Mode	Scheduled
Schedule	Daily, 23:00
Source	Photos
Destination	NetBackup
<a href="#">Advanced parameters</a>	

Select this option to begin the backup after you click Finish.

The Backup job will appear on the Backup page.

**Note on Manual Backups:** A manual backup must be started by the administrator:

1. Go to **Dashboard > Backup**.
2. Locate the manual backup job you wish to start then click on its grey arrow icon on the far right.

## REMOTE BACKUP: RSYNC

Please review the list of prerequisites for a backup to an rsync-compatible server before following the instructions:

- The rsync-compatible NAS must be connected to a network, local or offsite.
- Your rsync-compatible NAS may require a unique username and password to act as a backup destination. Review the user manuals for your rsync-compatible NAS and router.
- Local network: you must have the name or IP address of the rsync-compatible NAS.
- Offsite: you must have its **public IP address**. You can find the public IP address by visiting <http://www.whatismyip.com/> or by accessing your router's management software. When searching for the public IP address, use a computer connected to the same router as the destination NAS. For further information, review the user manual for the offsite network router or contact your internet service provider. An explanation of IP addressing is available at [http://en.wikipedia.org/wiki/IP\\_address](http://en.wikipedia.org/wiki/IP_address).
- Offsite: you may need to open ports using your router's management software. Review the user manuals for your rsync-compatible NAS and router.



## ADDING AN RSYNC BACKUP

1. Go to **Dashboard > Backup**.
2. Choose **Add backup** to launch the Backup & Restore Wizard.

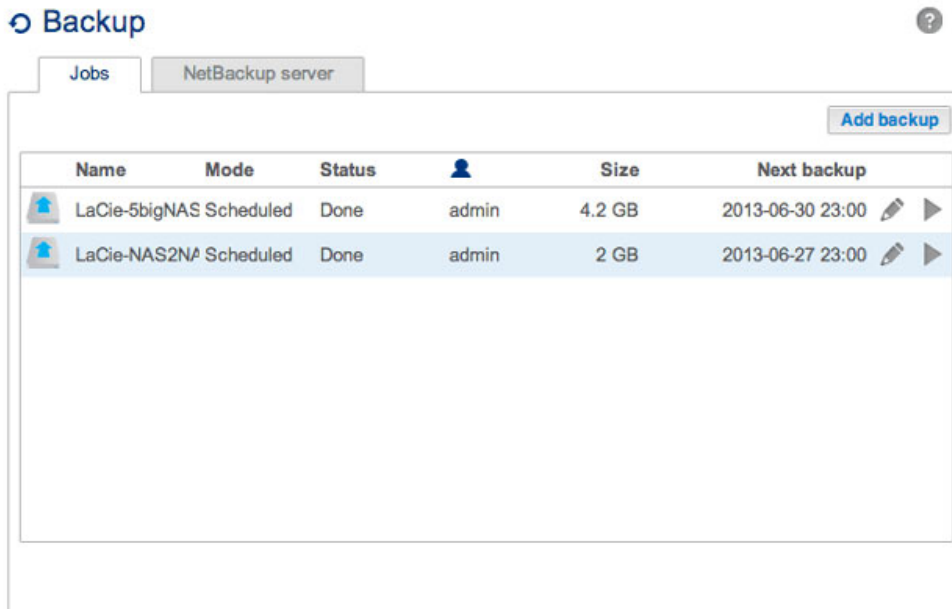

3. Select **Network backup** and choose **Next**.

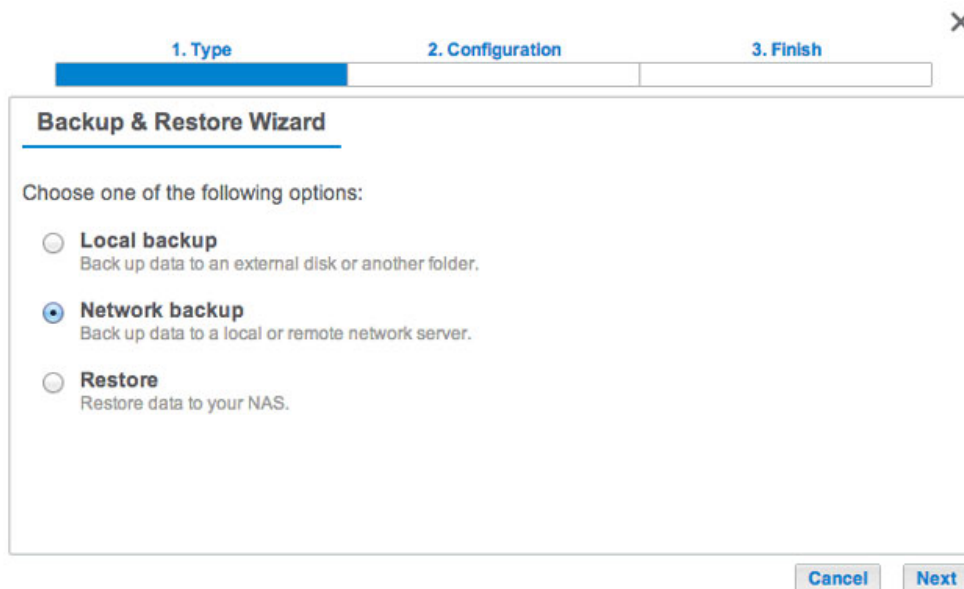

4. Select the share(s) you want to back up and choose **Next**.

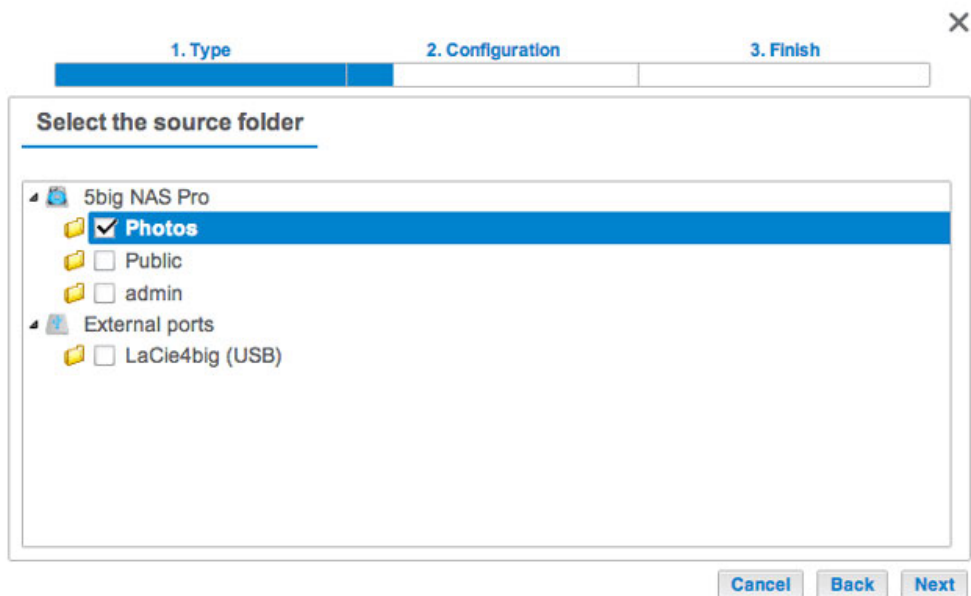

5. Select **Rsync-compatible server** and choose **Next**.

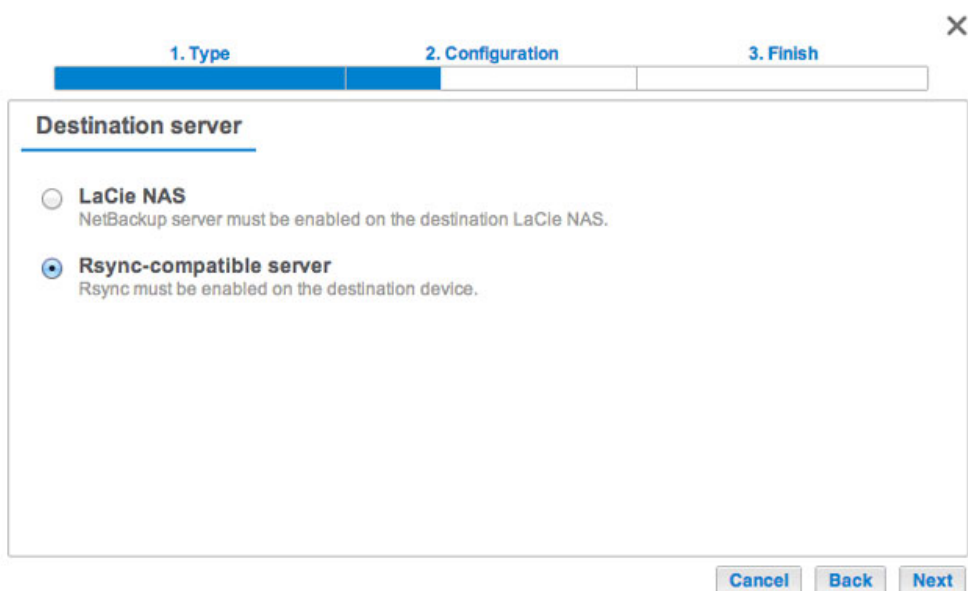

6. Local network: enter the destination NAS's name or IP address. Offsite network: enter the destination NAS's public IP address. If you do not know the public address for the destination NAS, please refer to the offsite network router's documentation or contact the internet service provider. Choose **Next** to continue.

7. Enter the login and password for the rsync-compatible NAS (see the rsync-compatible NAS's documentation for details on creating a login and password for network backups). If the destination NAS cannot be found, please make certain that:
  - It is powered on and out of sleep mode.
  - The proper IP address has been entered.
8. The Advanced parameters window lists four options for your backup job. See the explanations below. It is not mandatory to select one or more of the parameters to continue with the backup:

- *Secure data transfers* uses encryption during the data transfer. The data is not encrypted once it is stored on the destination NAS. This option is ideal for offsite backups.
- *Compressing data* optimizes data transmission rates. Data is compressed during the transfer only. While this option is good for low bandwidth networks, it can affect the NAS's performance.
- *Sending modified parts of files* is best used with backups that include files larger than 50MB. For example, if you edit a document that has already been backed up, only the edits will be copied during the next backup. This option can affect the NAS's performance.
- *Maintain files on the destination folder* keeps files on the destination NAS even if they are deleted from the

original NAS's source folder.

9. Choose **Next**.
10. Set the frequency for the backup.

1. Type      2. Configuration      3. Finish

**Backup mode**

**Manual**  
Create and initiate backups as needed.

**Scheduled**  
Schedule an automated backup: daily, weekly, monthly, or custom.

Cancel   Back   Next

- *Manual*: You must initiate the backup. See the note below.
  - *Scheduled*: The backup will begin at the scheduled time.
11. Enter a name for the backup job then choose **Next**.

1. Type      2. Configuration      3. Finish

**Choose a backup name**

Name your backup job:

Cancel   Back   Next

12. Confirm the backup settings on the *Summary* page. If you wish to begin the backup immediately, keep the box checked below the summary and choose **Finish**.

✕

1. Type      2. Configuration      3. Finish

---

**Summary**

Confirm your settings and click Finish.

Job	Rsync-BU
Type	Network backup - Mirror
Mode	Scheduled
Schedule	Daily, 23:00
Source	Photos, admin
Destination	10.21.57.42/SeagateNAS10
Advanced parameters	

Select this option to begin the backup after you click Finish.

The Backup job will appear on the Backup page.

**Backup** ?

Jobs    NetBackup server

Name	Mode	Status		Size	Next backup
LaCie-5bigNAS Scheduled	Scheduled	Done	admin	4.2 GB	2013-06-30 23:00
LaCie-NAS2NA Scheduled	Scheduled	Done	admin	2 GB	2013-06-27 23:00
Rsync-BU	Scheduled	<div style="width: 19%;"><div style="background-color: #0070C0; width: 19%;"></div></div> 19%	admin	-	-

**Note on Manual Backups:** A manual backup must be started by the administrator:

1. Go to **Dashboard > Backup**.
2. Locate the manual backup job you wish to start then click on its grey arrow icon on the far right.

# RESTORE A LOCAL BACKUP

**Restore and Remote Backups:** Remote backups cannot be restored using the Backup & Restore Wizard. You can retrieve backup files directly from the backup storage.

1. Go to **Dashboard > Backup**.
2. Choose **Add backup**.

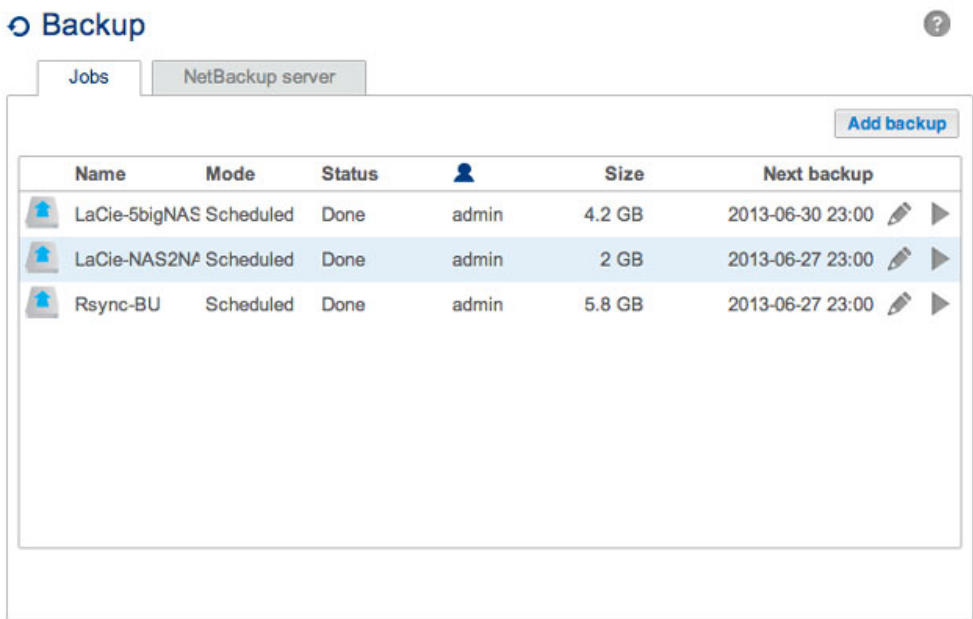

3. Select **Restore** and choose **Next**.

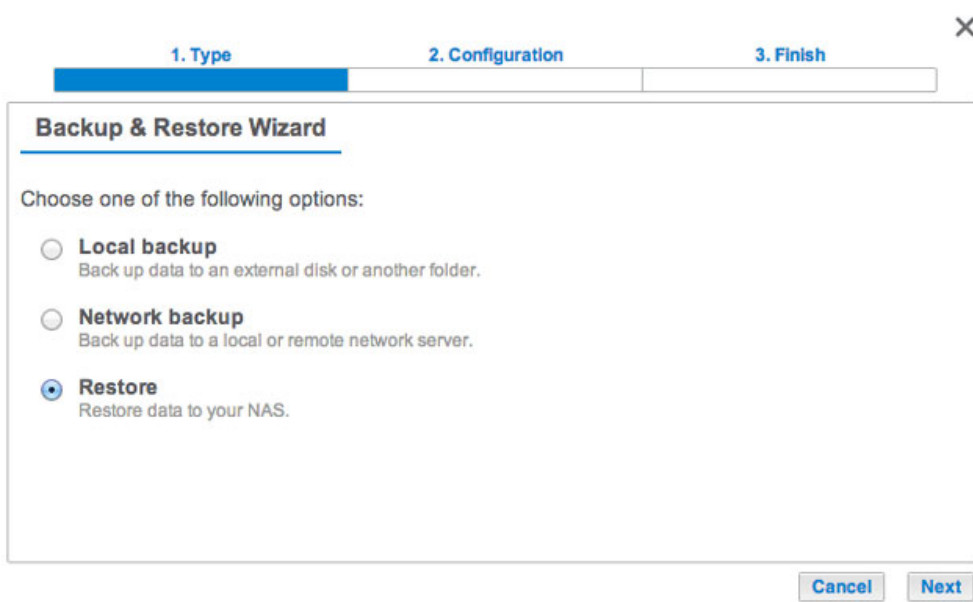

4. Select a restore type, either from an existing backup job, or from a backup folder. Choose **Next**.

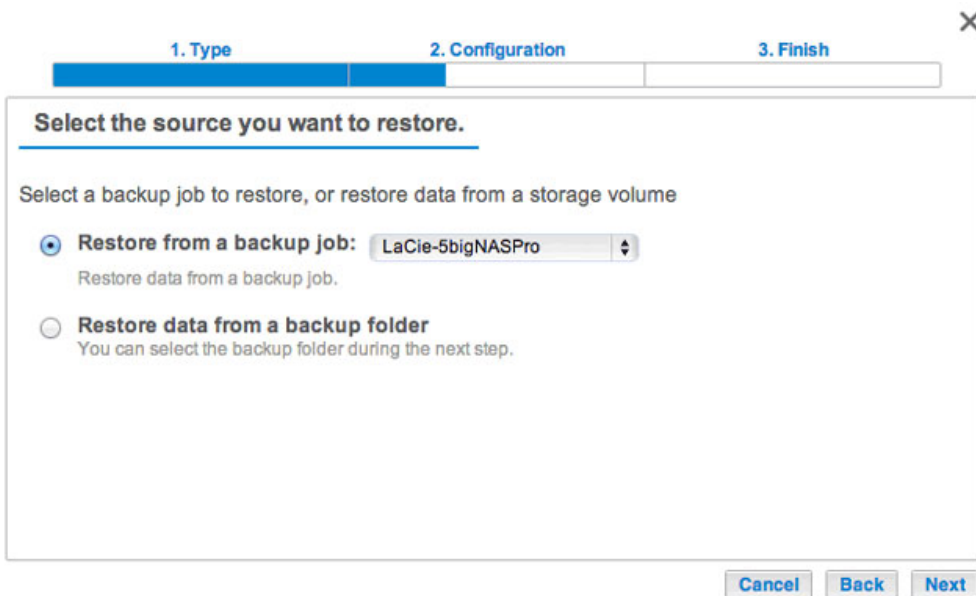

- Backup job: select the backup job from the pull-down menu, then choose **Next**.
  - Backup folder: browse for the source folder that hosts your backup. Select the backup directory and choose **Next**.
5. Review the summary of the restore then choose **Next**.

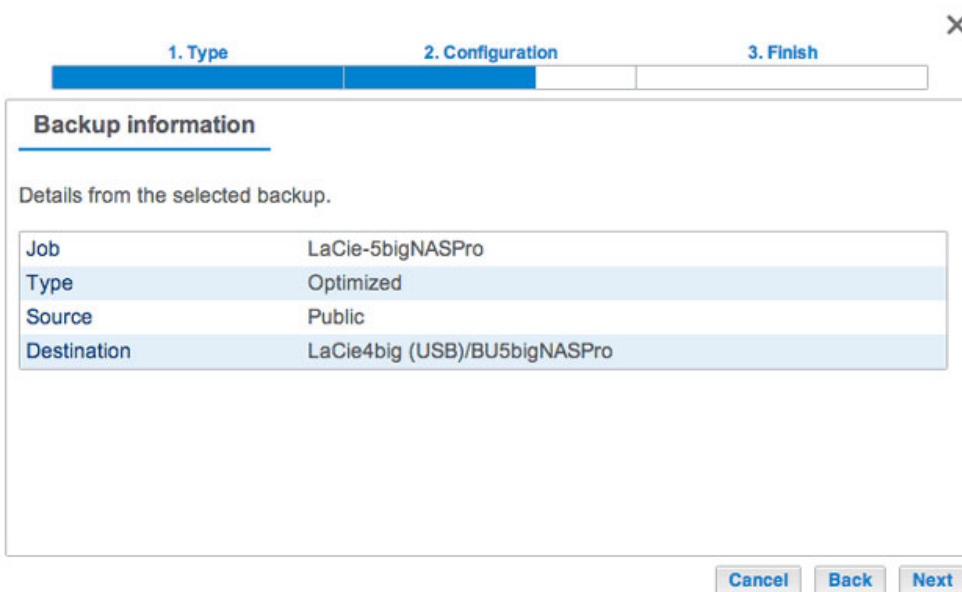

6. Select the last backup or choose an earlier *restore point*. A restore point is the date for a backup. You can select an earlier restore point from the calendar and the time from the drop-down menu. Choose **Next**.

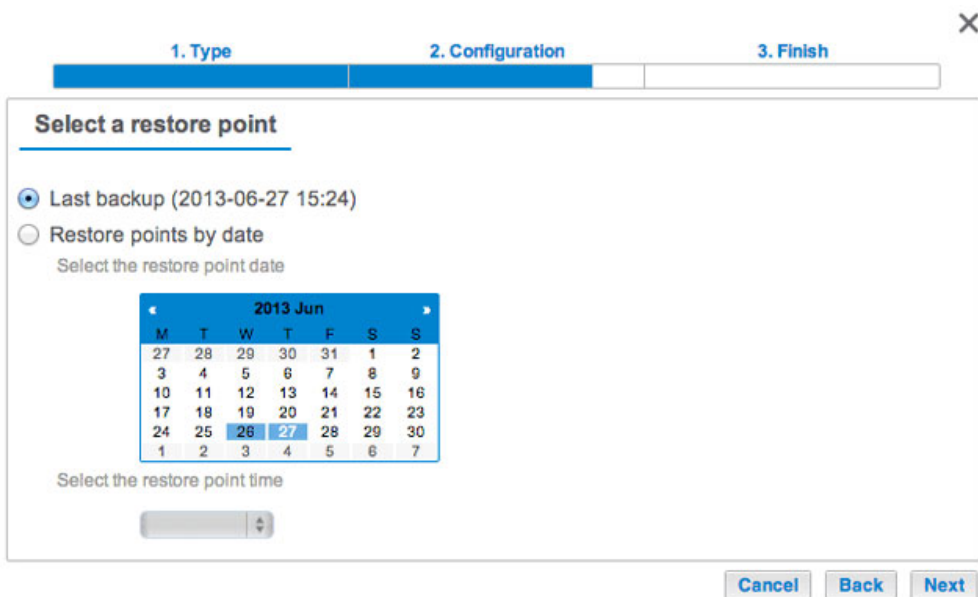

7. Choose where to restore the backup.

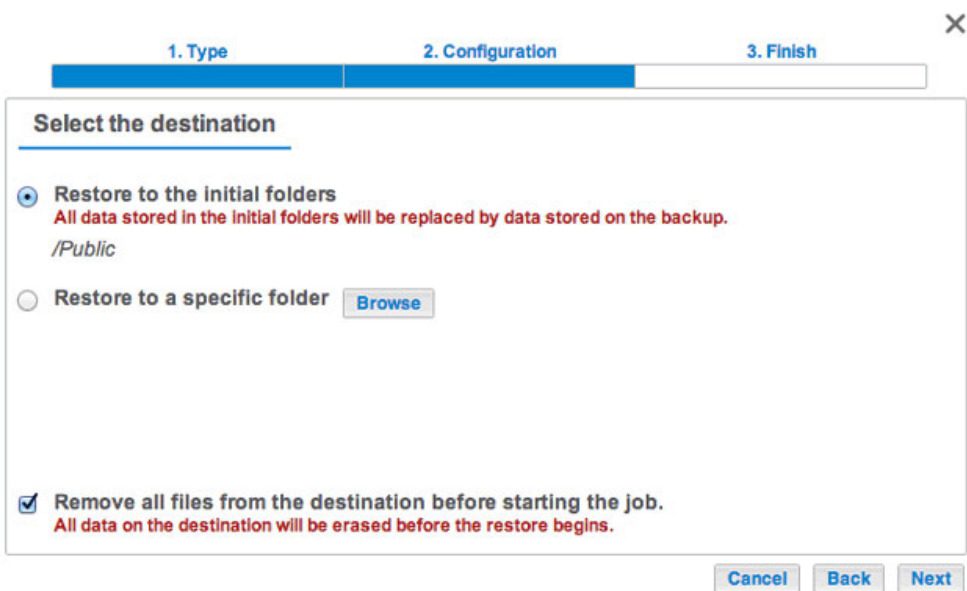

- Restore to the initial location of the data, which will save the data on the source folder. By default, the box *Remove all files* on the bottom of the window is checked. By keeping this box checked, **all changes since the date of the backup will be lost**. You can deselect the box to keep all data.
  - If you want to restore the backup to a specific folder, select **Browse** to choose another destination. You can create a folder in the new location. Choose **Apply**.
  - To free disk space, you can check the box to erase all data in the destination directory.
8. Name the restore job, then choose **Next**.



1. Type      2. Configuration      3. Finish

**Choose a restore name**

Name your restore job

Cancel   Back   Next

9. Review the summary for the restore job then choose **Finish** to add the job.

1. Type      2. Configuration      3. Finish

**Summary**

Confirm your settings and click Finish.













Job	Restore-NAS
Source	/LaCie4big (USB)/BU5bigNASPro/LaCie-5bigNASPro
Destination	/Photos/
Restoration date	2013-06-27 15:24
Erase destination before	No

Cancel   Back   Finish

The Restore job has been added to the list of backup jobs.

### Backup ?

Jobs | NetBackup server Add backup

Name	Mode	Status		Size	Next backup
 LaCie-5bigNAS Scheduled	Scheduled	Done	admin	4.2 GB	2013-06-30 23:00  
 LaCie-NAS2NA Scheduled	Scheduled	Done	admin	2 GB	2013-06-27 23:00  
 Restore-NAS -	-	<div style="width: 8%;"><div style="width: 8%;"></div></div> 8%	admin	-	- 
 Rsync-BU Scheduled	Scheduled	Done	admin	5.8 GB	2013-06-27 23:00  

# START/STOP EXISTING BACKUP JOBS

Locate the job you wish to modify at **Dashboard > Backup** and choose its configuration icon (pencil). You can get detailed information on a job or choose delete/enable/disable.

If you disable a scheduled job, it will not run until it is enabled again.

## STARTING/STOPPING JOBS

Start and stop icons appear on the far right of the backup jobs table:

- Start a job: Choose the triangular play icon.
- Stop a job that is in progress: Choose the square stop icon.

## REMOTE ACCESS: SDRIVE AND LACIE MYNAS

Remote access to your LaCie NAS is available using:

- Sdrive
- LaCie MyNAS
- FTP (see [Accessing Shares via FTP](#))

While Sdrive and MyNAS are easy to configure, they differ in accessing data and managing the NAS from remote locations:

- Sdrive is an application with file system integration. Once Sdrive is launched, a separate volume becomes available on your computer similar to a standard DAS or NAS. Sdrive also gives you access to NAS OS.
- LaCie MyNAS provides direct access to the Dashboard using an internet browser and does not require additional software. However, file integration is not available with LaCie MyNAS so files must be uploaded and downloaded via the File Browser (see [File Browser](#)).

# SDRIVE

Sdrive is an application for:

- Windows
- Mac OS
- iOS
- Android

## DOWNLOAD AND INSTALL SDRIVE

Go to the [Sdrive download page](#) to download and install the application for your operating system.

## CREATE AN SDRIVE ACCOUNT

Sdrive requires a user account for local and remote access. Therefore, the first time a user launches Sdrive, he can create a free account and associate it with NAS OS devices on the local network.

1. Following the installation, launch Sdrive.
2. If you already have an account, enter your Sdrive Username and Password. If you do not have an account, choose **Sign up**.
3. When signing up, fill in all the applicable fields. Check the box next to **I have read and agree with the Terms of Service** and choose **Create a new account**.

Your personal account has been created. An email is sent confirming your Sdrive account.

## ACCESSING SDRIVE

Once it is launched, Sdrive takes on two roles:

- An application to manage NAS OS devices.
- A volume to access content at the file level.

### Sdrive application

Click on the Sdrive icon to access its features. The Sdrive icon location differs by operating system:

- Windows: **System tray > Hidden icons** (up arrow in the system tray). See below for instructions on how to add the Sdrive icon to the system tray for easy access.
- Mac: Menu bar.

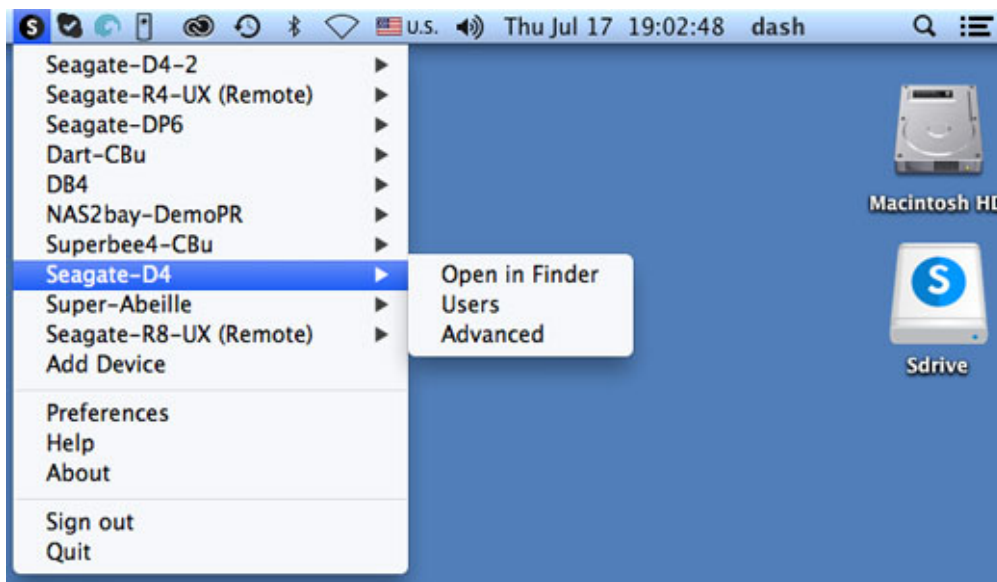

Similar to most applications in the system tray or menu bar, actions depend upon the operating system. For example, Windows users must apply a right click on the Sdrive icon to access most of its features. A left click in Windows launches the Sdrive volume in an Explorer window. Mac users can use a standard left click.

## Sdrive volume

The Sdrive volume gives users quick access to files on their NAS OS devices.

- Windows: **Explorer window > Network**

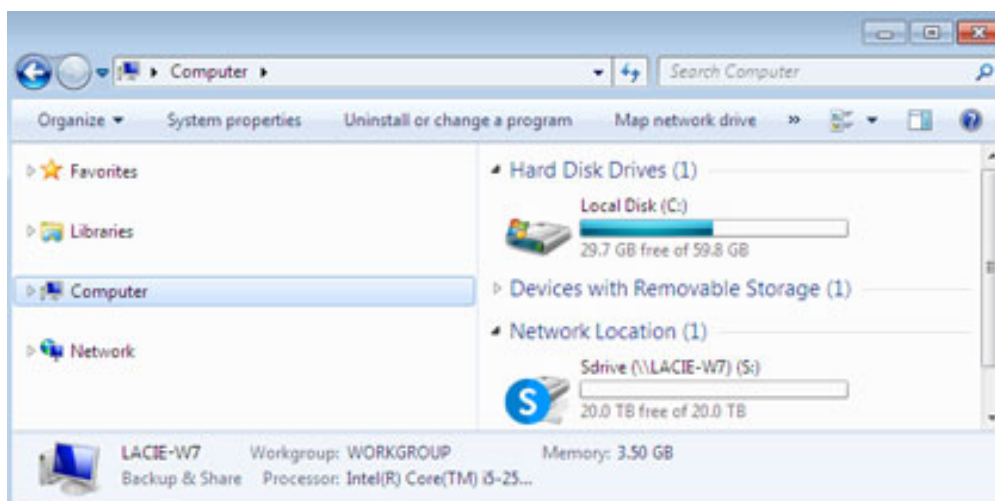

- Mac: Desktop

## Windows: Move the Sdrive icon to the system tray

1. In the system tray, click on **Hidden icons** (up arrow).

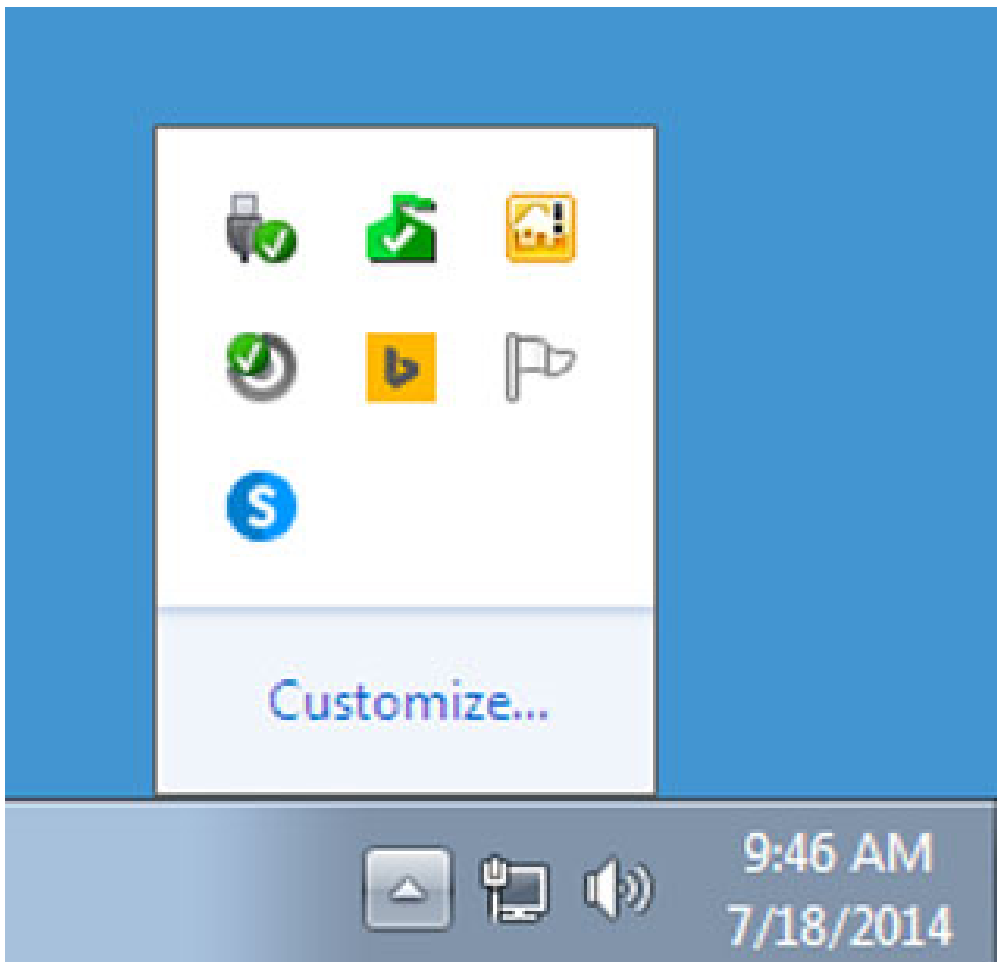

2. Choose **Customize**.
3. Click on the pull-down menu for Sdrive and choose **Show icon and notifications**.

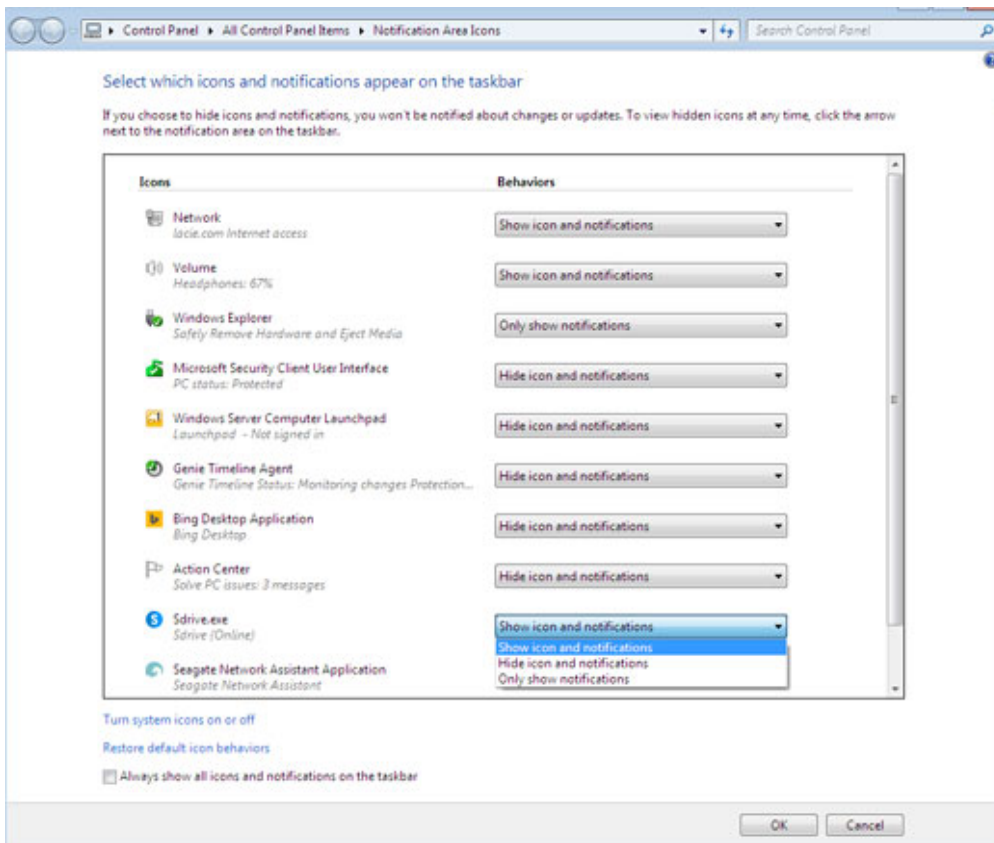

4. Choose **OK**.

## LINK SDRIVE TO YOUR NAS OS DEVICE

- Sdrive recognizes all compatible LaCie and Seagate NAS OS devices on your local network. All devices must run the latest version of NAS OS.
- Sdrive helps you navigate NAS OS shares on your local network, similar to traditional network volumes.
- Sdrive gives you and your colleagues access to your NAS OS shares anywhere with a connection to the internet.

## Add your NAS OS device to Sdrive

Users and administrators must perform the steps below on a computer connected to the same network as the NAS OS device. Once the NAS OS device is added to an Sdrive account, access is available outside of the local network.

1. Launch the Sdrive application and sign in using Sdrive credentials.
2. Click on the Sdrive icon.
  - Windows: Go to the system tray and right click on the Sdrive icon.
  - Mac: Go to the menu bar and click on the icon.
3. Select the NAS OS device and choose **Add to Sdrive**.



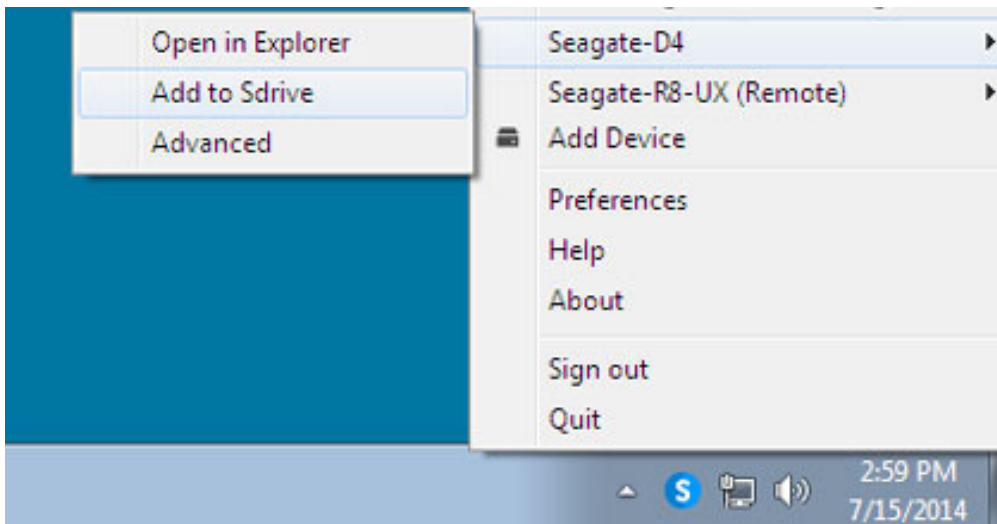

4. Enter the **username and password for the NAS OS device**. Do not enter the credentials for Sdrive at this step.

The NAS OS device has been added to the Sdrive account. The administrator can confirm that users have linked the NAS OS device to their Sdrive accounts.

1. Go to **LaCie Dashboard > Users**.
2. In the Users table, review the Sdrive account column. It is filled in automatically once the NAS OS device is added to an existing user's Sdrive account.

The administrator cannot edit the Sdrive account field in the Users table for NAS OS. However, the administrator can remove a user's link to Sdrive using the Edit pull-down menu.

## NAS OS discovery

If Sdrive cannot find your compatible NAS OS device, confirm that your company's firewall permits the following:

- Multicast UDP
- Group = 224.0.0.1
- Port = 4448 (in and out)
- TCP is enabled for port 18811 (out only)
- A proxy server for your NAS (if applicable)

## SDRIVE FEATURES

Sdrive has three primary functions:

- Local and remote access to NAS OS shares via the Sdrive volume.
- Remote NAS OS management for administrators and users.
- Share the NAS OS device by inviting colleagues and clients to join Sdrive.

## Sdrive remote access

Users and administrators must follow the installation and setup steps to link compatible NAS OS devices to their

Sdrive accounts. Once the link is established on the local network, the Sdrive application can be downloaded and installed on any computer with a connection to the internet.

For example, an employee wants to access her files from a home computer. After Sdrive is installed on the home computer, she signs in using the same Sdrive account created in the office. The Sdrive volume appears in an Explorer window (Windows) or the desktop (Mac).

The Sdrive installers are available at the [LaCie download page](#).

Remote access requires that:

- The NAS OS device is turned on.
- One or more ports on the company's router have been opened to allow access from outside the network.
- The Sdrive service is enabled in NAS OS.

## Sdrive remote management

Administrators and user can access NAS OS using Sdrive.

1. Launch the Sdrive application and sign in using Sdrive credentials.
2. Click on the Sdrive icon.
  - Windows: Go to the system tray and right click on the Sdrive icon.
  - Mac: Go to the menu bar and click on the icon.
3. Select the NAS OS device and choose **Advanced**.
4. The login page for the NAS OS device opens in the computer's default web browser. Enter the login credentials for the NAS OS device.

Administrators can view all NAS OS functions while users have limited access to their account information.

## Sdrive invitations to join the NAS OS device

An administrator can invite users to join the NAS OS device using Sdrive. Sdrive invitations perform two functions:

- Create a user account in NAS OS.
- Create a dedicated share with the user's name.

This option is ideal for sharing a NAS OS device with colleagues and clients who do not work within the local network. Users created in NAS OS should follow the steps in [Add your NAS OS device to Sdrive](#) and [Sdrive remote access](#).

Example 1: An employee in the office wants easy access to his files on the Seagate NAS OS device. Since he works within the local network, he follows the steps in [Add your NAS OS device to Sdrive](#) and [Sdrive remote access](#).

Example 2: The administrator wants to give a colleague in a branch office access to the NAS OS device at the company's headquarters. Once the invitation is accepted, the colleague has a user account and a dedicated share on the NAS OS device. The administrator can also give the colleague rights to access additional shares on the NAS OS device.

Example 3: The creative services team wants to share artwork with a client using secure remote access. The NAS OS administrator sends an Sdrive invitation to the client, automatically creating a user account and a dedicated share in the user's name. The administrator also gives the group Creative Services *read+write* access to the client's dedicated share (see [Groups](#) for instructions on how to manage multiple users in a single group). The creative services team can now collaborate with the client by sharing files on the dedicated share. Additionally, the administrator knows that the client only has access to the dedicated share. Sdrive provides ideal content sharing since it is secure and easy to manage.

## Administrator: Invite a user

1. Launch the Sdrive application and sign in using Sdrive credentials.
2. Click on the Sdrive icon.
  - Windows: Go to the system tray and right click on the Sdrive icon.
  - Mac: Go to the menu bar and click on the icon.
3. Select the NAS OS device and choose **Users**.
4. Enter the email address in the applicable field and then choose **Invite**.

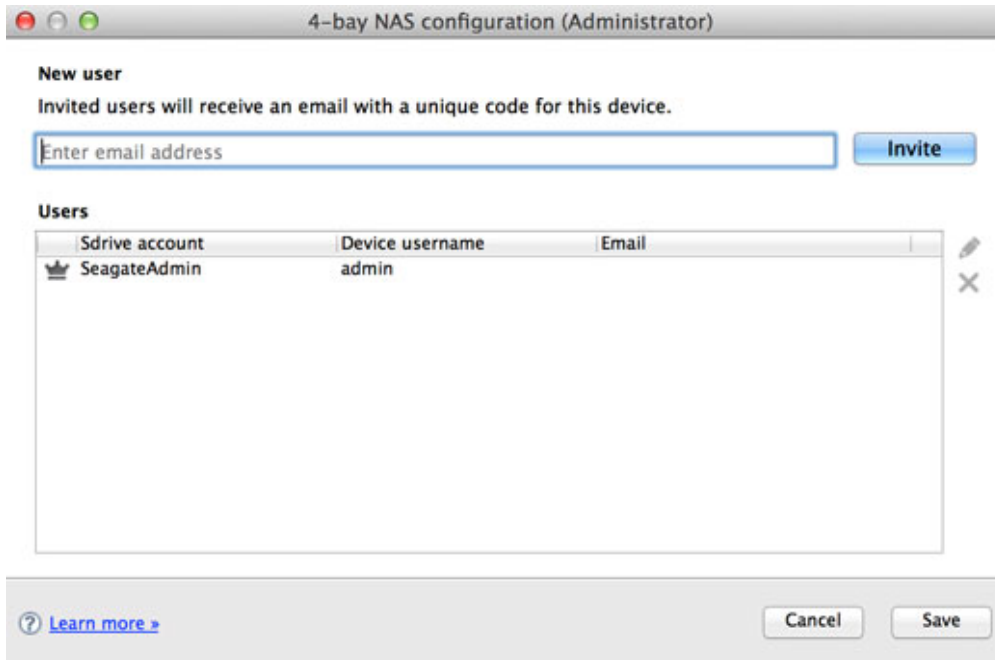

5. The user appears in the table. Choose **Save** to send the invitation.  
The user must accept the invitation for access to the NAS OS device.

## User: Accept the invitation

Open the email from the administrator and follow the steps to download and install Sdrive. The invitation includes a unique code.

A new share is created on the NAS OS device with each Sdrive invitation. The name of the share is determined by the name of the user's Sdrive account. For example, the name of the invitee.

By default, only the user has *read+write* access to the share that bears his name. However, the administrator can revise access rights to the share using the **Dashboard > Shares** page. See [Shares](#) for details.

## Administrator: Remove a user

A user added in Sdrive can be removed in the Sdrive Users window or in **Dashboard > Users** (see [Users](#) for details). To remove a user in Sdrive:

1. Launch the Sdrive application and sign in using Sdrive credentials.
2. Click on the Sdrive icon.
  - Windows: Go to the system tray and right click on the Sdrive icon.
  - Mac: Go to the menu bar and click on the icon.

3. Select the NAS OS device and choose **Users**.
4. Select the user you want to remove and click on the **X** on the right.
5. A popup window asks you to confirm.

If the user was created in Sdrive, he has an associated share on the NAS OS device with the same name. Deleting the user does not remove the associated share and its data. Additionally, a user cannot be recreated in Sdrive as long as the NAS OS device continues to have a share with the same name.

Instructions to remove a share are available at [Shares](#). Removing the share also deletes its data.

## Administrator: User accounts and preferences

The administrator can adjust usernames and passwords by choosing **Sdrive > NAS OS device > Users**. Select a user in the table and click on the pencil icon.

Sdrive options are also available at **Sdrive > Preferences**. Options include:

- Setting memory limits.
- Removing NAS OS devices from the account.
- Adjusting the account profile.

# LACIE MYNAS

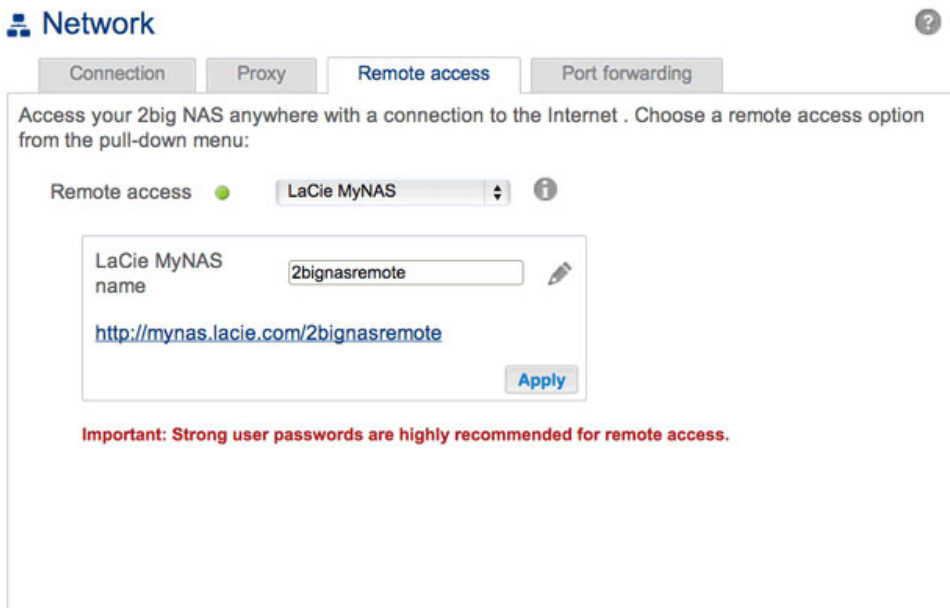

MyNAS provides direct access to NAS OS using an internet browser. However, MyNAS does not offer the type of file integration found with Sdrive. Therefore, files must be uploaded and downloaded via the File Browser (see [File Browser](#)).

## SET UP LACIE MYNAS REMOTE ACCESS

**Important info:** In order to prevent unauthorized access, it is critical to protect user and administrator accounts registered to your NAS OS device with a strong password BEFORE setting up remote access. Since MyNAS lets you access your data with a simple URL, unwanted users could access the NAS's files unless each authorized user is protected by a strong password. For added protection, a user can select secure authentication by choosing **Switch to HTTPS** at the NAS OS login.

1. Navigate to **Dashboard > Network > Remote Connection**.
2. In the **Remote Access** drop-down menu, choose **LaCie MyNAS**.
3. Type a name for your LaCie NAS in the **Name** field. The name should be different than the NAS OS device's network name.
4. Choose **Apply**. The Dashboard queries the MyNAS server to see if the name is available. If so, a message confirms the connection.

---

## Status



Your LaCie MyNAS remote access is now configured.

Use the following address to access your 2big NAS:

<http://mynas.lacie.com/2bignasremote>

Close

---

If your name is already chosen, type a new one and choose **Apply** until you find an available name.

# FAILED CONNECTION

If you receive an error that your LaCie NAS is unable to connect to the internet:

- You may require a proxy server to access the internet. Contact your network administrator or internet provider then review [Network](#) for further instructions on how to add your proxy server's address.
- You may need to configure port forwarding on your router. See the steps below.

# ROUTER

If the issue is related to your router, you must access its administration page in order to forward a port (by default, 8080), which creates a path from your LaCie NAS to the internet. From the router's administration page, select its port forwarding tab to assign a port to the LaCie NAS. Refer to your router's documentation for details.

Once a port has been selected on your router, you must assign the port on the LaCie NAS:

1. Go to **Dashboard > Network > Remote Access**.
2. Next to the **Name** field, select the configuration icon (pencil) and choose **Advanced settings**. (If you do not see the configuration icon next to the **Name** field, first type a name and then choose **Apply**. The icon should appear.)
3. In the dialogue window that appears, choose **Manual**.
4. Type the port you forwarded in your router. In the screenshot below, port 54200 has been forwarded.

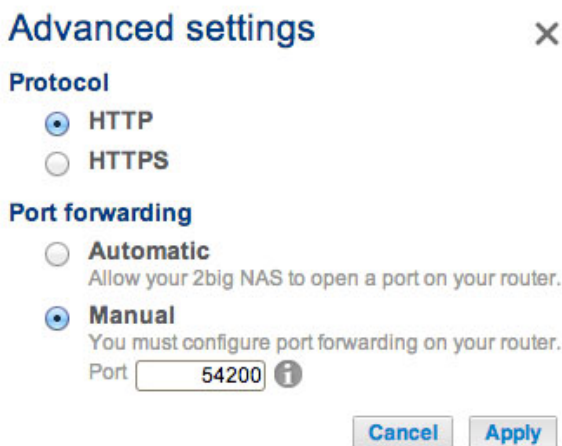

5. Choose **Apply**.

# USING LACIE MYNAS REMOTE ACCESS

Once MyNAS is successfully configured, simply type your LaCie NAS's URL into any browser, anywhere.

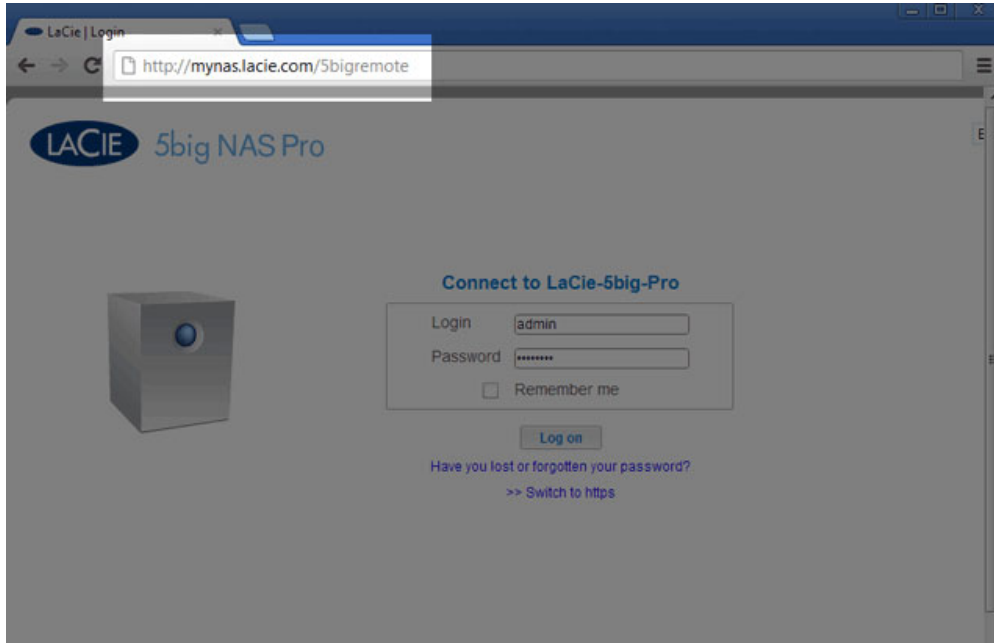

Your URL is: `mynas.lacie.com/mynas_name`

The `mynas_name` is the name selected on the remote access page and not the NAS's network name.

After entering the URL, you are prompted to log in to the Dashboard. Enter the username and password created by the administrator. Once logged in, an administrator can administer the NAS. Users and administrators can use File Browser to upload and download files (see [File Browser](#)).



## MOBILE APPS

Sdrive and LaCie MyNAS are available as apps for your mobile devices. See the table below for compatibility:

	<b>iOS</b>	<b>Android</b>
Sdrive	Yes	Yes
LaCie MyNAS	Yes	Connect via an internet browser

# GETTING HELP

If you are having problems with your LaCie product, consult the table below for a list of available resources.

Order	Source	Description	Location
1	Quick Install Guide	Concise steps to follow for getting your product up and running	Either a printed leaflet or accessory box and included in the product box, or download PDF from the product page
2	Support Pages	Includes interactive troubleshooting topics for most common problems	<a href="http://www.lacie.com/support/">www.lacie.com/support/</a> , select your product, then click the "Troubleshooting" tab
3	User Manual	Includes common troubleshooting topics	See <b>Troubleshooting Topics</b> below
4	Customer Support	Create an account on <a href="http://lacie.com">lacie.com</a> , register your product, and fill out a support ticket	Create an account here: <a href="http://www.lacie.com/us/mystuff/login.htm?logout&amp;rtm=mystuff">www.lacie.com/us/mystuff/login.htm?logout&amp;rtm=mystuff</a>

**Note:** LaCie is dedicated to providing high quality products that enrich the lives of our customers. To help LaCie offer the best customer support, we encourage you to create an account and register your product at [www.lacie.com/us/mystuff/login.htm?logout&rtm=mystuff](http://www.lacie.com/us/mystuff/login.htm?logout&rtm=mystuff). You can give us important feedback as well as receive updated information on your LaCie device.

## SOFTWARE UPDATES

LaCie frequently releases firmware updates to improve the functionality of products. Please check for recent updates to firmware and to LaCie Network Assistant to ensure optimum product performance. See [Support](#) for details.

## TROUBLESHOOTING TOPICS

**Note:** Interactive troubleshooting, a highly effective way to resolve problems with your product, is available from [www.lacie.com/support/](http://www.lacie.com/support/). Select your product, then click the “Troubleshooting” tab.

### Troubleshooting the Network Connection

#### **No shares appear on the network.**

Q: Is the NAS's power supply connected and is the front blue light on?

A: Make sure that the power supply is properly connected (see [Connect to the Network](#)); that the system has been powered on pushing the button on the back; and that the outlet the power supply is connected to is powered on or has a sufficient supply of power.

Q: Is the blue light on the front of the device flickering for an inordinate period of time?

A: See [LED Behavior and Button Functions](#) for details.

Q: Did you follow the correct installation steps?

A: Review [Connect to the Network](#).

Q: Are both ends of the Ethernet cable firmly connected?

A: Disconnect the Ethernet cable, wait 10 seconds and then reconnect.

Ensure that the interface connectors are properly aligned. The Ethernet cable can only be inserted one way. Make sure it is correctly oriented.

Check that the Ethernet connectors are straight and fully seated in the Ethernet ports.

Make sure that you use the Ethernet cable that came in the box from LaCie.

---

Q: IP address problem?

A: By default the LaCie NAS is configured to retrieve its IP address from a DHCP server. If your network is managed by a DHCP server and you cannot access your LaCie NAS, try checking your DHCP server's log. To find the IP address for your LaCie NAS, run LaCie Network Assistant [LaCie Network Assistant](#). If no DHCP server is detected, the product will run APIPA to assign itself an IP address. Additionally, confirm that your computer is connected to the same network as the LaCie NAS.

Q: How can I find the public IP address for advanced features such as offsite backups and remote FTP access?

A: You can find the public IP address by clicking [here](#). You must use a computer connected to the same router as the LaCie NAS.

---

**A user does not have access to the LaCie NAS Dashboard or shares.**

Q: Has the administrator created an account for the user?

A: In order for another user to access the LaCie NAS, two conditions must be met: 1) the administrator must create and provide the user with username and password; 2) the LaCie NAS must be connected to the network via Ethernet for users to access the shares.

**I cannot access my account. I enter my login and password and receive an error message.**

Q: Is your password correct?

A: If you added an email address ([Users](#)) and configured the SMTP server ([Support](#)), you can reset your password. To do this, click on the “forgot my password” link on the login page. Follow the instructions to complete the reset. User: If you cannot recover the password, contact the NAS administrator. Administrator: If you cannot recover the password, contact the alternate NAS administrator. If you are the sole administrator for the NAS, see:

- [Reset to Factory Conditions: 2big NAS](#) (2big NAS)
- [LaCie NAS Rescue: 5big NAS Pro](#) (5big NAS Pro)

**I've noticed a delay in accessing the shares.**

Q: Are you transferring multiple files simultaneously, using the download feature, or synchronizing the RAID?

A: Running all or some of the following operations at once can impact LaCie NAS performance: accessing to a share; file transfers; torrent activity; synchronizing the RAID. Enabling the UPnP service can also slow performance due to media indexing. For information on services, see [General Settings](#). To review CPU performance, go to the Hardware monitor page (see [Hardware Monitoring](#)).

## Troubleshooting the Multimedia Server

### I cannot see the media files stored on the LaCie NAS.

Q: Are the media files stored on a public share? Is the multimedia service active?

A: UPnP AV devices can discover media files stored public shares. Certain devices may have difficulty locating files on a private share or, you will be prompted for a password. Make certain that the multimedia service is enabled in the Dashboard (see [General Settings](#) for more information). If you continue to experience problems, try disabling and enabling the service.

---

### Windows Media Player

Q: I can't configure Windows Media Player to find media files on the LaCie NAS.

A: Windows Media Player should play back media files stored on public shares.

---

Q: Certain files aren't recognized by Windows Media Player.

A: Windows Media Player has file type restrictions. See the Windows Media Player web site for further information: <http://windows.microsoft.com/en-US/windows/products/windows-media-player>.

---

### iTunes

Q: Some files appear in my iTunes™ shared playlist, but some do not.

A: The iTunes Server Service supports certain file types. See the iTunes website for further details: <http://www.apple.com/itunes/>.

---

Q: I've activated the LaCie NAS's iTunes service in General Settings, but I don't see its machine name in iTunes.

A: In iTunes preferences, make certain that the box next to **Shared Libraries** is checked.

---

Q: Why aren't files stored on the network storage appearing in iTunes?

A: iTunes Server Service will only access public folders. Therefore, put your music on public folders if you wish to play it using iTunes.

---

### UPnP/DLNA-Compatible Game Consoles and Set Top Boxes

Q: Some files stored on the LaCie NAS appear on my UPnP/DLNA compatible device, but others do not.

A: Each UPnP/DLNA media player has its own file type restrictions. See their respective websites and documentation for complete lists of compatible file types.

---

## Troubleshooting Expansion Device Connection

### **I connected a USB drive to the enclosure, but the drive does not appear on the Storage page.**

Q: Is the drive's file system supported by the LaCie product?

A: Your LaCie NAS only recognizes external hard drives with the following file systems: FAT32, NTFS, HFS+, EXT2, EXT3, EXT4 and XFS. If your drive's file system is not one of those listed, reformat it, then reconnect to the LaCie NAS.

---

### **I can't copy a file from a share to the DAS connected to my LaCie NAS.**

Q: Is the DAS formatted in FAT32 and is the file larger than 4GB?

A: Files larger than 4GB cannot be transferred to a FAT32 volume.

---

### **I think that the hard disk is making unusual noises.**

Q: Is the sound "soft clicking" or "hard clicking"?

A: Soft clicking can be the normal sound of the hard drive working. If the hard drive is functional, this is normal. Hard drives do not typically give an indication of any problems prior to failure, so it does not mean it is about to fail if the hard drive is making a clicking sound and still functioning. You can check the status of your hard drives by running a SMART test (see [Hardware Monitoring](#)).

Hard clicking is a very noticeable sound, and is akin to hearing metal-on-metal impacts. This behavior is usually indicative of a physical failure. If nothing traumatic happened to the hard drive prior to this starting, consider it to be soft clicking, and troubleshoot the problem as suggested above.

---

### **The VGA monitor that I connected to the LaCie 5big NAS Pro appears to be receiving a signal but the screen is black.**

Q: How long has the VGA monitor been connected to the NAS?

A: The VGA signal reverts to energy saving mode within a few minutes. If the monitor appears to be receiving a signal but no image is present, try to connect a USB keyboard to one of the LaCie 5big NAS Pro's USB ports. Tap on one of the keys to view the LaCie 5big NAS Pro VGA signal.

---

## Troubleshooting the Active Directory (AD) Connection

The numbered list below provides general troubleshooting recommendations to resolve problems with AD.

### LaCie NAS

1. Confirm that your NAS is running the latest NAS OS firmware (see [Support](#)).
2. Check the Hardware monitor page to review CPU usage (see [Hardware Monitoring](#)). You can experience AD connection problems if the CPU is running high. Actions or jobs that can burden the CPU include:
  1. RAID synchronization (in this case, wait until the RAID is built)
  2. Multiple download jobs are running (stop or wait until download is finished)
  3. Multimedia reindexing (disable UPnP)
  4. Backup jobs are running (stop or wait until backup jobs are finished)
  5. Multiple simultaneous data transfers to/from the NAS from computers on the network (wait until the transfers are complete)
3. Make sure the product is assigned the correct date, time, and time zone (see [General Settings](#)). A time discrepancy of more than five minutes between the domain and the product may prevent or cause disruptions to the Active Directory (AD) connection. This tolerance is defined in Domain Controller Policy, and the default value is usually five minutes.

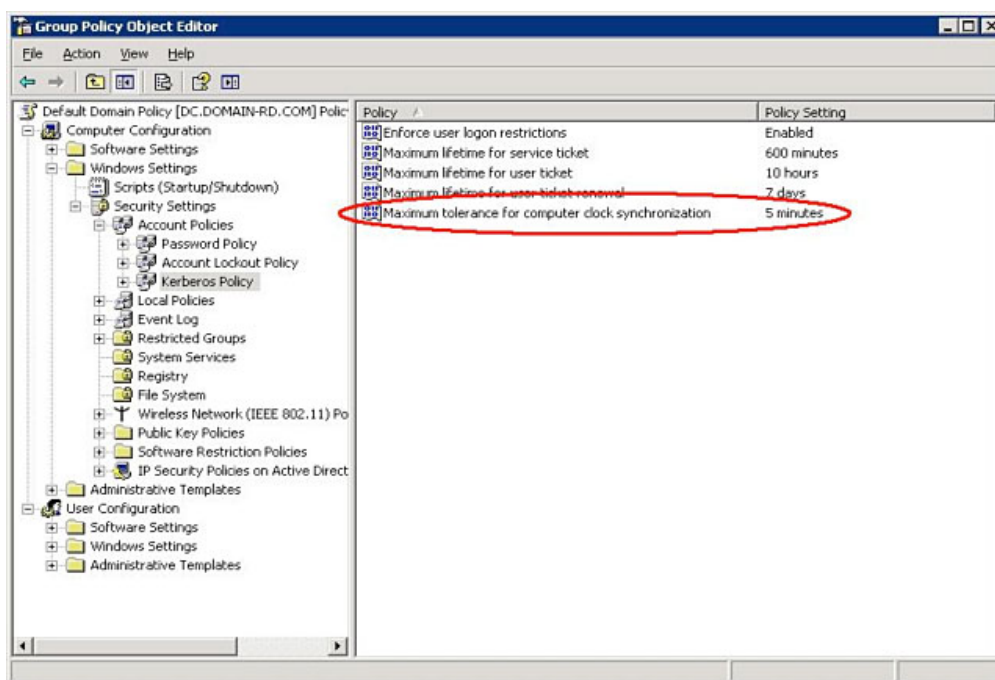

4. Make sure that the DNS server address provided to the NAS is a domain DNS, not an internet DNS provided by an internet service provider (see [Network](#)). The NAS must connect to the local network domain, not to a server on the internet.

The NAS must be assigned a DNS server IP address on the local network configuration since joining a domain is based upon DNS resolution. To verify that the NAS is using a DNS IP address, try to ping the DNS server from a computer on the same network.

5. General Settings > Workgroup/Domain (see [General Settings](#)):

1. Enter the domain's Full Qualified Domain Name (FQDN). For example:  
**directory-example.domain.com** (Active Directory Users and Computers Tool on Primary Domain Controller)

**Domain configuration** ✕

Machine name LaCie-5big-Pro

Fully-qualified domain name

Administrator login

Administrator password

▼ [Advanced criteria \(optional\)](#)

Server name

Server IP  .  .  .

2. Administrator login: The AD's administrator username.
  3. Administrator password: The AD's administrator password.
6. Advanced criteria (optional).
1. **Server Name** is the Domain Controller Host Name
  2. **Server IP** is the Domain Controller IP



## Active Directory

The AD administrator can check the following:

1. Verify if Kerberos Server & Time Server are registered in the domain DNS, allowing the LaCie NAS to connect. Kerberos Server & Time Server need to be accessible to the NAS, as these servers are involved in the joining process.
2. Confirm that the machine name object is placed in the right container (not the default “computer” container) and check access rights for the machine name (such as who can log on). If necessary, delete the machine name in order to reset the object in AD.

The domain administrator can create a computer account in AD and place it in the right container prior to joining the LaCie NAS to the domain (the computer account name is the NAS's name).

3. Sub-domains can create problems when joining a domain. Confirm that the proper domain is being used and review the machine name object location/rights. As well, see if the user belongs to a different sub-domain. If so, review the user's rights to determine if there is an authorization conflict that prevents access to the NAS.

# RESET TO FACTORY CONDITIONS: 2BIG NAS

## RESET THE DASHBOARD SETTINGS

### Important info:

- Following these steps will erase all Dashboard data such as users, groups, shares, and settings. It will also reset the machine name to the default and reset the network settings to DHCP.
- Connected DAS will not be affected by the NAS reset.
- User data is moved to a folder named **Recovery** in a share named **Share**. Only the administrator can access **Share**.

1. Power off the 2big NAS.
2. Press and hold down the front LED button. Without releasing the front button, turn the product on using the power switch on the rear of the product.
3. Keep the front button pressed until the front LED becomes solid red, then release it.
4. The LED will blink red. Within five seconds, press the front button once to confirm the reset. The front LED will blink blue for several seconds.

The front LED will blink red/blue during a system reset. The LaCie 2big NAS is ready when it reboots and the front LED is static blue.

## FORMAT, DELETE, OR RECREATE THE VOLUME

Once the NAS is reset, you can:

- Access your data on **Share**
- Format the existing volumes
- Delete the existing volumes
- Create new volumes

See [Storage](#) for instructions on formatting, deleting, and creating volumes.

**Caution:** Formatting, deleting, or recreating existing volumes will erase all the data on the NAS. Make sure to back up all your data onto another storage device before proceeding. LaCie cannot be held responsible for any loss of data.

# LACIE NAS RESCUE: 5BIG NAS PRO

The LaCie NAS Rescue can help you troubleshoot potential technical problems. The Rescue includes three recovery options:

- **Data Recovery:** Enable FTP Access to the data on your LaCie 5big NAS Pro. Once enabled, you can use FTP client software or a web browser to back up the data stored on your LaCie 5big NAS Pro.

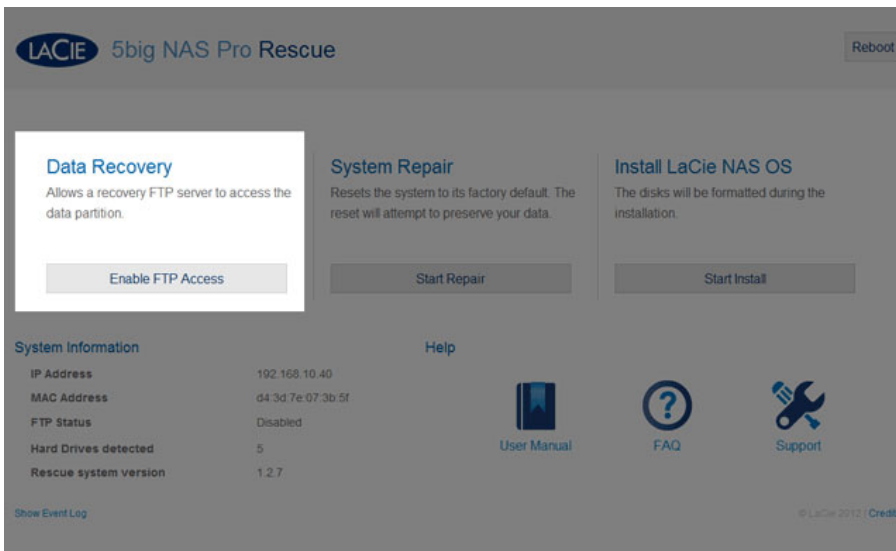

- **System Repair:** The Rescue will reset your LaCie 5big NAS Pro to its factory default while attempting to preserve the shares and data. LaCie cannot guarantee that all your data will be saved. Factory default includes the reversion of all Dashboard parameters (e.g. Users, General Settings, Network, etc.) to their original states.

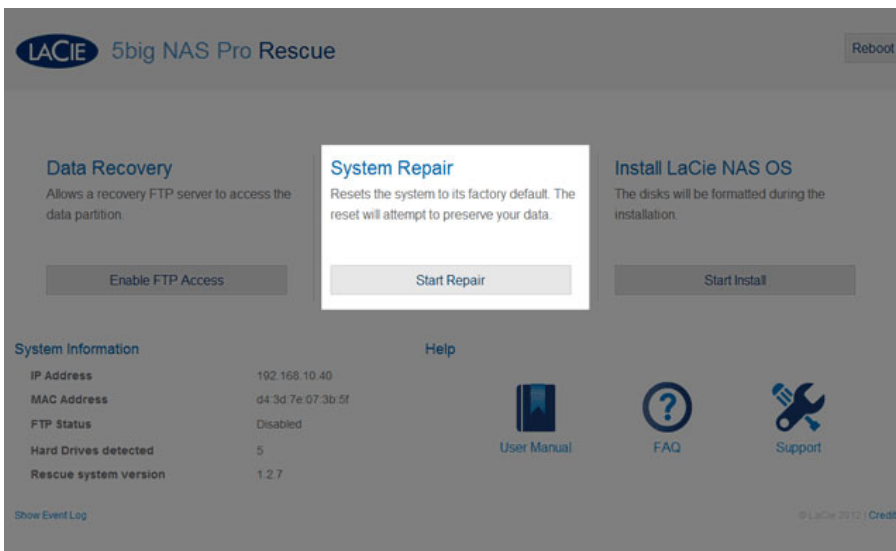

- **Install LaCie NAS OS:** The Rescue will format the LaCie 5big NAS Pro hard drives before reinstalling LaCie NAS OS. Since all data will be deleted during the format, LaCie highly recommends that you back up your files before selecting this option.

**LACIE** 5big NAS Pro Rescue Reboot

### Data Recovery

Allows a recovery FTP server to access the data partition.

[Enable FTP Access](#)

### System Repair

Resets the system to its factory default. The reset will attempt to preserve your data.

[Start Repair](#)

### Install LaCie NAS OS

The disks will be formatted during the installation.

[Start Install](#)

  

#### System Information

IP Address	192.168.10.40
MAC Address	d4:3d:7e:07:3b:5f
FTP Status	Disabled
Hard Drives detected	5
Rescue system version	1.2.7

[Show Event Log](#)

#### Help



User Manual



FAQ



Support

© LaCie 2017 | [Credits](#)

## PREPARE FOR THE RESCUE

The LaCie NAS Rescue will prompt you to enter:

1. The LaCie 5big NAS Pro's IP address or network name
2. The LaCie 5big NAS Pro's MAC address (Your LaCie 5big NAS Pro has two MAC addresses, one for each LAN port. You may use either MAC address for the Rescue.)

To find the addresses:

- Check the sticker located on the bottom of your LaCie 5big NAS Pro enclosure for the MAC address.
- Launching LaCie Network Assistant to review MAC and IP address information (see [LaCie Network Assistant](#)).
- Connect a VGA monitor to the NAS's VGA port.

VGA Monitor

While not obligatory, you can connect a compatible monitor to the LaCie 5big NAS Pro before following the [Rescue Steps](#). Doing so will help you confirm that the LaCie 5big NAS Pro boots from the LaCie USB Key to enter Rescue mode. You can also review the device's IP and MAC addresses once it has entered Rescue mode.

The VGA signal reverts to energy saving mode within a few minutes. If the monitor appears to be receiving a signal but no image is present, try to connect a USB keyboard to one of the LaCie 5big NAS Pro's USB ports. Tap on one of the keys to view the LaCie 5big NAS Pro VGA signal.

## LaCie Network Assistant

If you do not see the LaCie 5big NAS Pro in LaCie Network Assistant, confirm that your LaCie 5big NAS Pro is:

- Connected to the same network as the workstation you are using. In certain configurations, the LaCie 5big NAS Pro is connected to two separate networks (see [Port Aggregation: Multiple Networks, Bonding, and Fault Tolerance](#)).
- Connected to the same network as the workstation you are using via the LAN 1 Ethernet port. LaCie Network Assistant requires that LAN 1 act as the primary Ethernet port for your LaCie 5big NAS.

If you still do not see your device in LaCie Network Assistant, follow the instructions below:

1. Launch LaCie Network Assistant.
2. Select **Preferences...**
  1. Windows: Right click on the LaCie Network Assistant icon in the system tray.

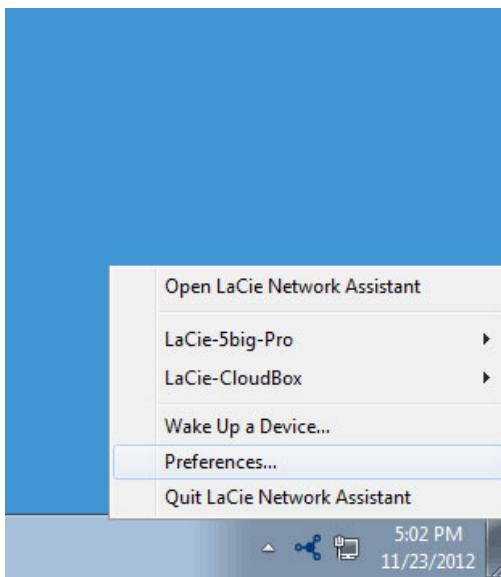

2. Mac: Click on the LaCie Network Assistant icon in the menu.

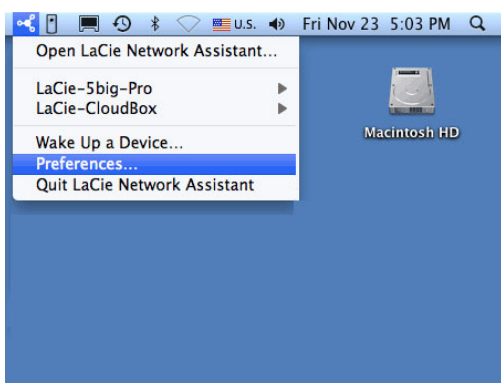

3. Enable IPConf Support by clicking on **Activate**.

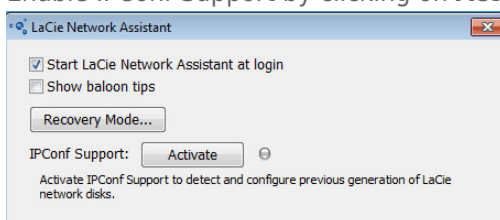

**Select Activate to enable IPConf Support**

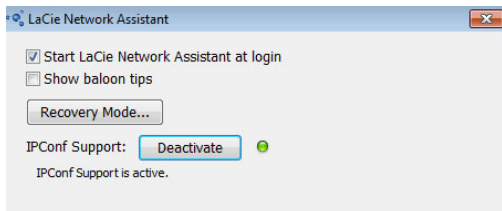

**The digital green LED indicates IPConf Support is enabled.**

**Caution:** Recent versions of the LaCie Network Assistant Preferences include the button **Recovery Mode**. This option does not launch the Rescue and is not compatible with the LaCie 5big NAS Pro.

## RESCUE STEPS

### Step 1: Update the LaCie USB key

The included USB flash drive allows you to boot the LaCie 5big NAS Pro and run the NAS OS Rescue (*LaCie key*). However, before running the Rescue, it is highly recommended that you download a more recent version of the software as it may have been updated since you received your NAS.



The software that you download onto the LaCie key NAS is not the NAS OS. Rather, it is a utility to run the NAS OS Rescue so that you can install or repair the NAS OS.

To update the LaCie key:

1. Insert it into a USB port on a computer with a connection to the internet.
2. Launch an internet browser and enter the following address: <http://www.lacie.com/lakeynas>
3. Follow the onscreen directions to update the software on the LaCie key.
4. Eject the key from your computer.



Step 2: Back up and power off the LaCie 5big NAS Pro

The LaCie NAS Rescue will attempt to repair or reset the NAS OS. To guarantee that data stored on the LaCie 5big NAS Pro is preserved, LaCie highly recommends that you back up all shares before moving forward with the Rescue. If you cannot access the NAS volumes, the Rescue provides an option to retrieve data via FTP.

Following the backup (if applicable), turn the NAS off. If you have access to the Dashboard, use the Dashboard power icon on the upper right of the window to select **Shutdown**. Otherwise, push the front LED button.

Step 3: Connect the LaCie key to the NAS

1. Connect the LaCie USB key to one of the USB ports on the LaCie 5big NAS Pro.

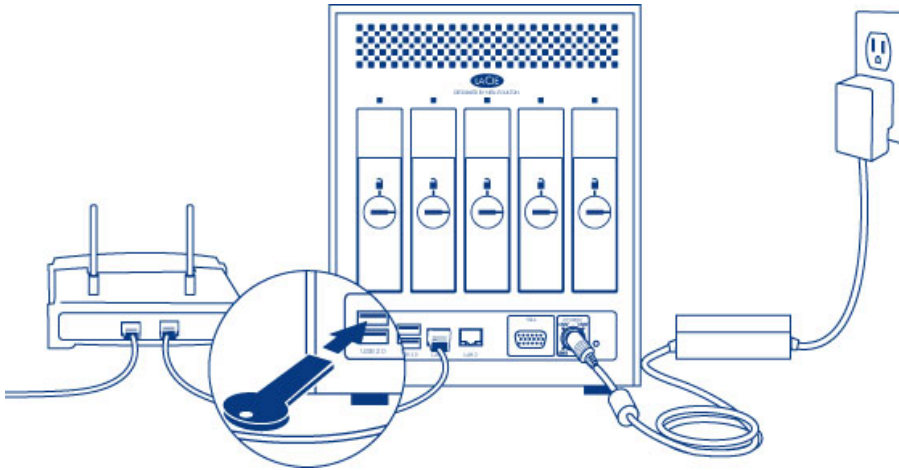

Step 4: Boot the LaCie 5big NAS Pro from the LaCie key

1. Locate the LaCie drive lock tool provided with your LaCie 5big NAS Pro.

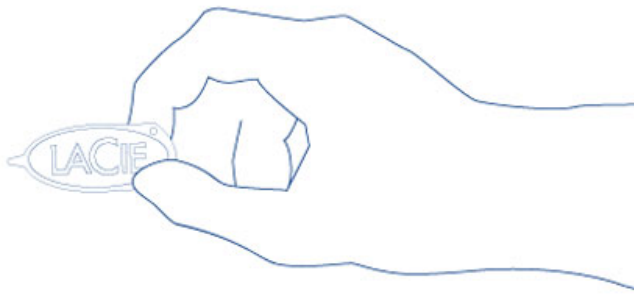

2. Insert the pointed end of the drive lock tool into the E-boot port on the back of the device. You will feel minor resistance as you push the reset button.

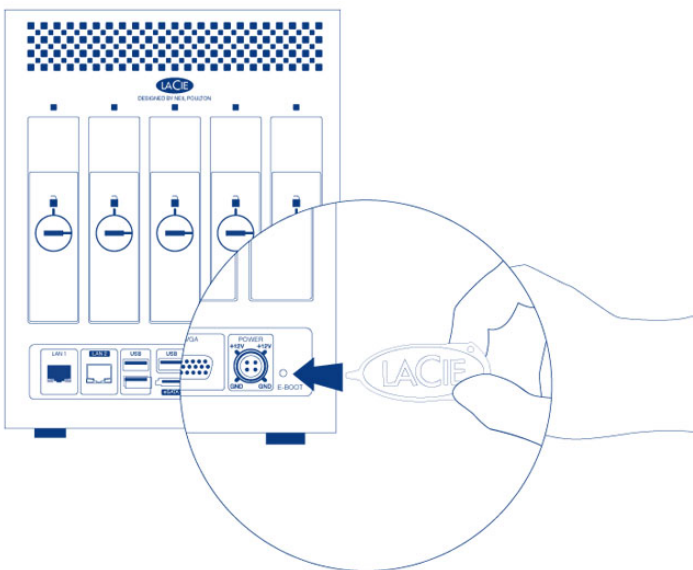

3. While you are pushing the reset button with the drive lock tool, turn on the LaCie 5big NAS Pro by pushing the front LED button. **DO NOT** remove the drive lock tool as the LaCie 5big NAS Pro powers on. Doing so will prevent the LaCie 5big NAS Pro from using the LaCie USB Key as the boot device.

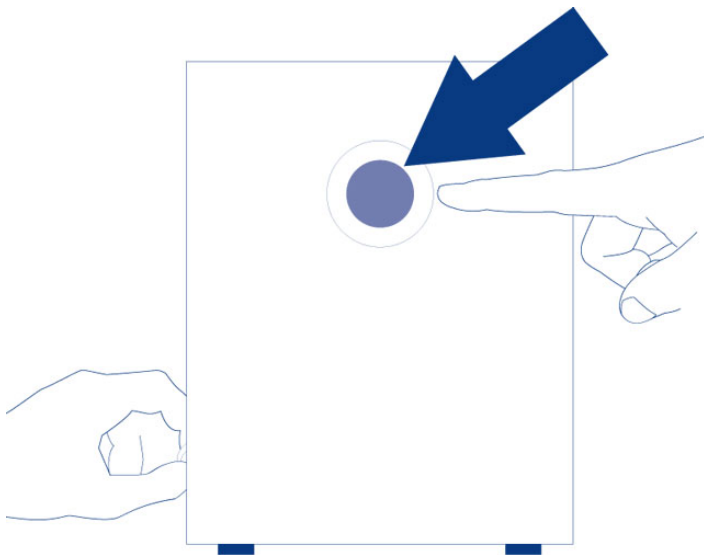

4. Release the reset button 10 seconds after all the rear disk LEDs turn solid blue.

The reset button is required when disks are present in the NAS since it sets the boot priority to the key. If there are no disks in the NAS, the device will boot directly from the LaCie key.

Step 5: Launch the LaCie 5big NAS Pro Rescue

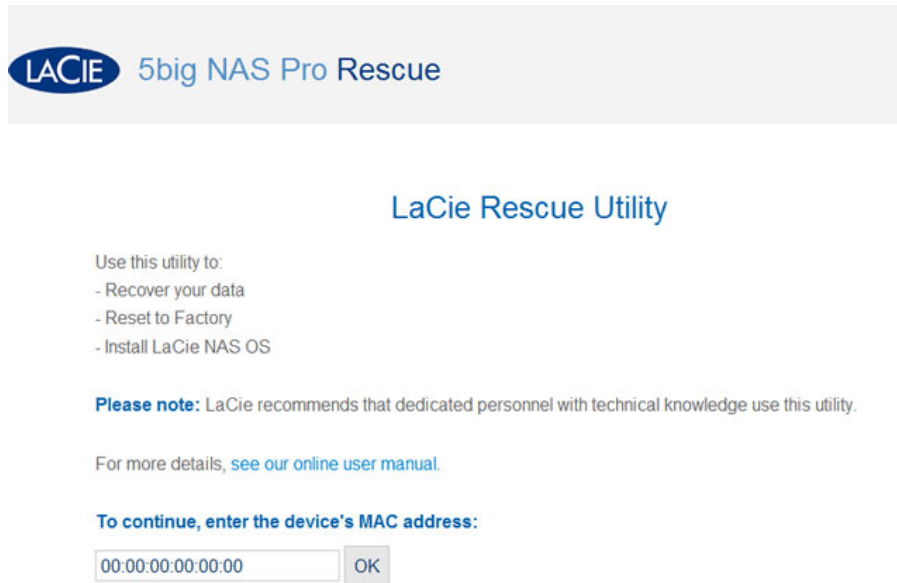

1. Go to LaCie Network Assistant to select **LaCie-5big-pro > Web Access....** If the LaCie NAS Rescue does not appear, enter the IP address or name in your browser's address bar (URL). For example, <http://192.168.10.40> or <http://lacie-5big-pro.local>. (The default name of your LaCie 5big NAS Pro, *lacie-5big-pro*, will differ if you have changed it.)

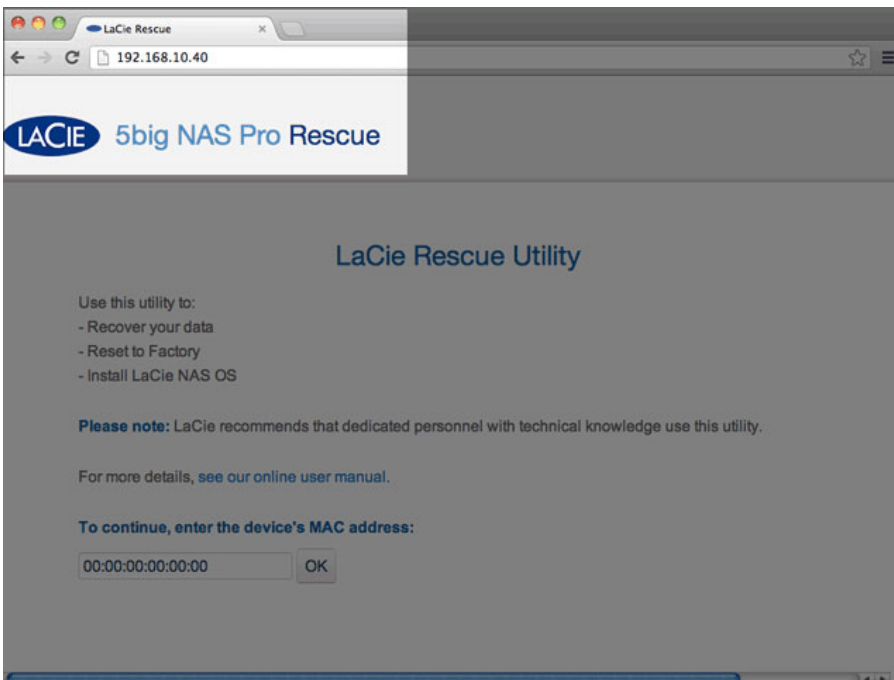

2. Enter one of the MAC addresses in the available field. It is not necessary to enter the colons.

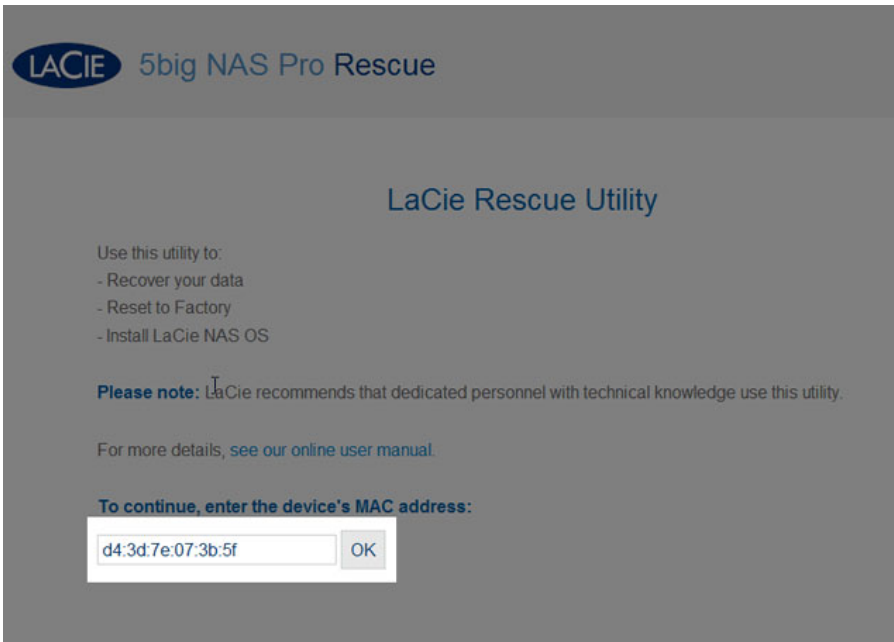

3. At the prompt, select your preferred type of Rescue and follow the onscreen instructions.

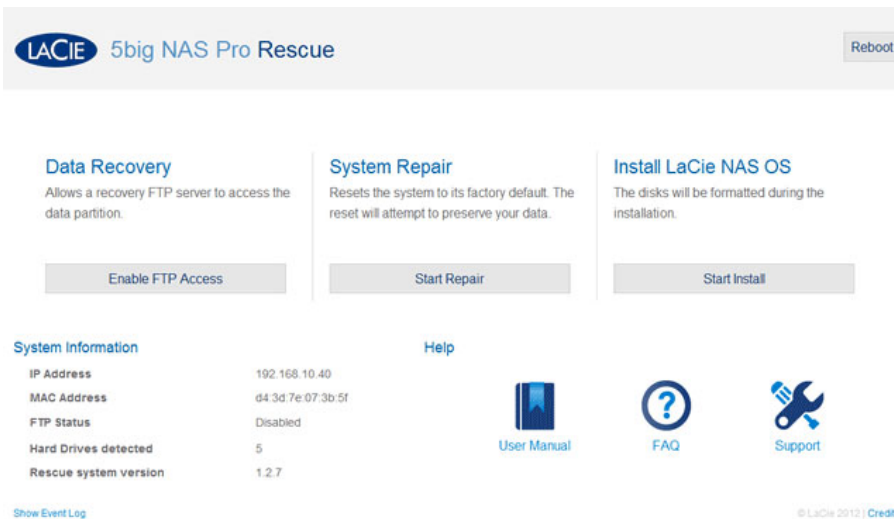

The NAS OS Rescue will perform a file system check (*fsck*) to determine if the device was improperly powered off or crashed, causing an inconsistent state for the NAS OS. The *fsck* will attempt to repair or recover damaged system files.

# MAXIMUM ELEMENTS BY FEATURE

The table below provides the maximum amount of elements allowed for specific features.

Feature	2big NAS	5big NAS Pro
Users	2048	2048
Groups	256	256
Shares	256	256
iSCSI Targets	10	32
Volumes	2	5
Volume size	108TB	108TB

# LEGAL INFO

## COPYRIGHTS

Copyright © 2015 LaCie. All rights reserved. No part of this publication may be reproduced, stored in a retrieval system, or transmitted in any form or by any means, electronic, mechanical, photocopying, recording or otherwise, without the prior written consent of LaCie.

## CHANGES

The material in this document is for information only and subject to change without notice. While reasonable efforts have been made in the preparation of this document to assure its accuracy, LaCie assumes no liability resulting from errors or omissions in this document, or from the use of the information contained herein. LaCie reserves the right to make changes or revisions in the product design or the product manual without reservation and without obligation to notify any person of such revisions and changes.

## FEDERAL COMMUNICATION COMMISSION INTERFERENCE STATEMENT

This equipment has been tested and found to comply with the limits for a Class B digital device, pursuant to Part 15 of the FCC Rules. These limits are designed to provide reasonable protection against harmful interference in a residential installation. This equipment generates, uses and can radiate radio frequency energy and, if not installed and used in accordance with the instructions, may cause harmful interference to radio communications. However, there is no guarantee that interference will not occur in a particular installation. If this equipment does cause harmful interference to radio or television reception, which can be determined by turning the equipment off and on, the user is encouraged to try to correct the interference by one of the following measures:

1. Reorient or relocate the receiving antenna.
2. Increase the separation between the equipment and receiver.
3. Connect the equipment into an outlet on a circuit different from that to which the receiver is connected.
4. Consult the dealer or an experienced radio/TV technician for help.

FCC Caution: Any changes or modifications not expressly approved by the party responsible for compliance could void the user's authority to operate this equipment.

This device complies with Part 15 of the FCC Rules. Operation is subject to the following two conditions: (1) This device may not cause harmful interference, and (2) this device must accept any interference received, including interference that may cause undesired operation.

**Important info: FCC Radiation Exposure Statement:** This equipment complies with FCC radiation exposure limits set forth for an uncontrolled environment. This equipment should be installed and operated with minimum distance 20 cm between the radiator & your body.

This transmitter must not be co-located or operating in conjunction with any other antenna or transmitter. The availability of some specific channels and/or operational frequency bands are country dependent and are

firmware programmed at the factory to match the intended destination. The firmware setting is not accessible by the end user.

## WEEE



This symbol on the product or on its packaging indicates that this product must not be disposed of with your other household waste. Instead, it is your responsibility to dispose of your waste equipment by handing it over to a designed collection point for the recycling of waste electrical and electronic equipment. The separate collection and recycling of your waste equipment at the time of disposal will help to conserve natural resources and ensure that it is recycled in a manner that protects human health and the environment. For more information about where you can drop off your waste equipment for recycling, please contact your local city office, your household waste disposal service, or the shop where you purchased the product.

## TRADEMARKS

Apple, Mac, Time Machine, and Macintosh are registered trademarks of Apple Computer, Inc. Microsoft, Windows XP, Windows Vista, and Windows 7 are registered trademarks of Microsoft Corporation. Other trademarks mentioned in this manual are the property of their respective owners.

## LICENCES AND FREE SOFTWARE

Your LaCie product ships with copyrighted software that are licensed under the GPL, AFL, Apache, Apple, BSD, GNU LGPL, MIT, OpenLDAP, OpenSSL, PHP, Python, and Creative Common. It also includes free software, the source code for which can be downloaded from the LaCie website: [www.lacie.com/support/](http://www.lacie.com/support/)

© 2007-2008, Thomas BERNARD. © 2006 Allan Saddi allan@saddi.com © 2004, Jan Kneschke, incremental. © 2001-2006, Patrick K. O'Brien and Contributors. © 2003-2009 Stuart Bishop stuart@stuartbishop.net. © 2006 Kirill Simonov. © 1996-2006 Julian R Seward. © 2004, 2005 Darren Tucker. All rights reserved. © 1997-2008 University of Cambridge. All rights reserved. © 2007-2008, Google Inc. All rights reserved. © 1990-2003 Sleepycat Software. All rights reserved. © 1995-2004 Jean-loup Gailly and Mark Adler. © 2004 Micah Dowty. ® 1997-2006 by Secret Labs AB ® 1995-2006 by Fredrik Lundh. © 1988,1990,1993,1994 by Paul Vixie. © 2007-2009 Charles du Jeu.

This list of licenses can evolve over time and can be found on the user interface under the heading "Credits."

## CANADA COMPLIANCE STATEMENT

This Class B digital apparatus meets all requirements of the Canadian Interference-Causing Equipment Regulations.

CAN ICES-3 (B)/NMB-3(B)



## JAPAN COMPLIANCE STATEMENT

This is a Class B product based on the standard of the Voluntary Control Council for Interference from Information Technology Equipment (VCCI). If this is used near a radio/TV receiver, it may cause radio interference. Install the equipment according to the manual. This statement does not apply to the LaCie CloudBox.

## MANUFACTURER'S DECLARATION FOR CE CERTIFICATION



We, LaCie, solemnly declare that this product conforms to the following European standards: Electromagnetic Compatibility Directive (2004/108/EC); Low-Voltage Directive: 2006/95/EC

# PRECAUTIONS

**Caution:** It is essential that you use only the power supply that shipped with your product, since it is a shielded-type power cord that meets FCC emission limits as well as to prevent interference to the nearby radio and television reception.

**Caution:** Modifications not authorized by the manufacturer may void the user's authority to operate this device.

**Important info:** Any loss, corruption or destruction of data while using a LaCie drive is the sole responsibility of the user, and under no circumstances will LaCie be held liable for the recovery or restoration of this data. To help prevent the loss of your data, LaCie highly recommends that you keep TWO copies of your data; one copy on your external hard disk, for instance, and a second copy either on your internal hard disk, another external hard disk or some other form of removable storage media. If you would like more information on backup, please refer to our website.

**Important info:** 1TB (Terabyte) = 1,000GB. 1GB = 1000MB. 1MB = 1,000,000 Bytes. Total accessible capacity varies depending upon operating environment (typically up to 10% less per TB).

## HEALTH AND SAFETY PRECAUTIONS

- Only qualified persons are authorized to carry out maintenance on this device.
- Read this User Manual carefully and follow the correct procedure when setting up the device.
- Do not open a disk drive or attempt to disassemble or modify it. Never insert any metallic object into the drive to avoid any risk of electrical shock, fire, short-circuiting or dangerous emissions. The disk drives shipped with your LaCie device contain no user-serviceable parts. If it appears to be malfunctioning, have it inspected by a qualified LaCie Technical Support representative.
- Never expose your device to rain, or use it near water, or in damp or wet conditions. Never place objects containing liquids on the LaCie device, as they may spill into its openings. Doing so increases the risk of electrical shock, short-circuiting, fire or personal injury.
- Make sure that the computer and LaCie device are electrically grounded. If the devices are not grounded, there is an increased risk of electrical shock.

## GENERAL USE PRECAUTIONS

- Power requirements 100-240 V~, 50-60 Hz, (supply voltage fluctuations not exceeding  $\pm 10\%$  of the nominal and transient over-voltages according to over-voltage category II).
- Do not expose the LaCie device to temperatures outside the range of 5° C to 30° C (41° F to 86° F); or to operational humidity beyond 10-80%, non-condensing, or non-operating humidity beyond 10-90%, non-condensing. Doing so may damage the LaCie device or disfigure its casing. Avoid placing your LaCie device near a source of heat or exposing it to sunlight (even through a window). Inversely, placing your LaCie device in an environment that is too cold may damage the unit.
- Rated cooling for altitudes up to 2000 meters.
- If your drive features a power cable, always unplug it from the electrical outlet if there is a risk of lightning or if it will be unused for an extended period of time. Otherwise, there is an increased risk of electrical shock, short-circuiting or fire.
- Use only the power supply shipped with the device (if applicable).
- Do not use the LaCie device near other electrical appliances such as televisions, radios or speakers. Doing so may cause interference which will adversely affect the operation of the other products.
- Do not place the LaCie device near sources of magnetic interference, such as computer displays, televisions or speakers. Magnetic interference can affect the operation and stability of your LaCie device.
- Never use excessive force on your LaCie device. If you detect a problem, consult the troubleshooting section in this manual.
- Protect your LaCie device from excessive exposure to dust during use or storage. Dust can build up inside the device, increasing the risk of damage or malfunction.
- Never use benzene, paint thinners, detergent or other chemical products to clean the outside of the LaCie device. Such products will disfigure and discolor the casing. Instead, use a soft, dry cloth to wipe the device.

## WARRANTY INFORMATION

LaCie offers first-rate service and support through our generous three-tiered warranty policy. Our 1-, 2-, 3-, and 5-year policies include comprehensive, complimentary web-based resources, expert in-house technical support, and worldwide repair and/or replacement coverage. To benefit from this warranty, please contact LaCie Support at [www.lacie.com/us/support](http://www.lacie.com/us/support) where you can find online support and contact information. You may also contact representatives at the original point of purchase who will be able to help guide you.

Standard warranties vary depending on the product. To verify your product's warranty status and to see which standard warranty is included with your product, type in your product's serial number at [www.lacie.com/us/support](http://www.lacie.com/us/support). If no warranty is listed under your product's name, this means that the warranty has expired.

## WARRANTY UPGRADES

If you wish to extend your warranty coverage, you can purchase Silver, Gold, or Platinum Care or Advanced Exchange. For details, see [www.lacie.com/warranties](http://www.lacie.com/warranties).

## LEGAL INFORMATION

A standard LaCie limited warranty is included with all products. Please read the terms and conditions below.

### LaCie Limited Warranty Policy

LaCie ("LaCie") warrants, to the original purchaser, that this equipment shall be free of defects in materials and workmanship for a period of one (1), two (2), three (3), or five (5) years, depending on the model, from LaCie's date of original shipment when the equipment is used normally and is properly serviced when needed. If you discover a defect covered by the warranty set forth above, your sole and exclusive remedy will be for LaCie, in its sole discretion to (i) repair or replace the product at no charge to you; or, if a repaired unit or replacement product is not available, (ii) to refund the current market value of your product. You acknowledge and agree that replacement product, at the sole option of LaCie, may be a new product or a remanufactured product. In order to receive the remedy set forth above, you must return the product during the warranty period and include with each returned product (i) a copy of your original purchase invoice to verify your warranty; (ii) a Return Material Authorization number; (iii) your name, address and telephone number; (iv) a copy of the bill of sale bearing the appropriate LaCie serial numbers as proof of date of original retail purchase; and (v) a description of the problem. The customer must pay all transportation costs for a returned product. The product will need to be returned to LaCie within the country of original retail purchase. This warranty applies only to hardware products; LaCie software, media, and manuals are licensed and warranted pursuant to separate written agreement. This warranty does not apply if the product has been misused or has been damaged by accident, abuse, misuse, or misapplication; if it has been modified without permission of LaCie; or if any LaCie serial number has been removed or defaced. If a customer has purchased a LaCie Advance Care Option (ACO) to go with this equipment, the ACO shall be valid for three (3) years from activation.

EXCEPT FOR THE LIMITED WARRANTY SET FORTH ABOVE, ALL PRODUCTS ARE SOLD “AS IS” AND LACIE EXPRESSLY DISCLAIMS ALL WARRANTIES OF ANY KIND, WHETHER EXPRESS, IMPLIED OR STATUTORY, INCLUDING THE IMPLIED WARRANTIES OF MERCHANTABILITY, NONINFRINGEMENT AND FITNESS FOR A PARTICULAR PURPOSE. WITHOUT FURTHER LIMITING THE GENERALITY OF THE FOREGOING, DOES NOT WARRANT (1) THE PERFORMANCE OR RESULTS OBTAINED FROM USING THIS PRODUCT, (2) THAT THE PRODUCT IS APPROPRIATE FOR THE CUSTOMER'S PURPOSES, (3) THE MANUAL IS ERROR FREE, OR (4) THAT NO DATA WILL BE LOST WHILE USING THE PRODUCT. THE ENTIRE RISK AS TO THE RESULTS AND PERFORMANCE IS ASSUMED BY THE CUSTOMER. THE WARRANTY AND REMEDIES SET FORTH ABOVE ARE EXCLUSIVE AND IN LIEU OF ALL OTHERS, ORAL OR WRITTEN, EXPRESS OR IMPLIED.

## EXCLUSIONS AND LIMITATIONS

This Limited Warranty applies only to hardware products manufactured by or for LaCie that can be identified by the “LaCie” trademark, trade name, or logo affixed to them. The Limited Warranty does not apply to any non-LaCie hardware products or any software, even if packaged or sold with LaCie hardware. Manufacturers, suppliers, or publishers, other than LaCie, may provide their own warranties to the end user purchaser, but LaCie, in so far as permitted by law, provides their products “as is”. Software distributed by LaCie with or without the LaCie brand name (including, but not limited to system software) is not covered under this Limited Warranty. Refer to the licensing agreement accompanying the software for details of your rights with respect to its use.

LaCie does not warrant that the operation of the product will be uninterrupted or error-free. LaCie is not responsible for damage arising from failure to follow instructions relating to the product's use. This warranty does not apply: (a) to consumable parts, unless damage has occurred due to a defect in materials or workmanship; (b) to cosmetic damage, including but not limited to scratches, dents and broken plastic on ports; © to damage caused by use with non-LaCie products; (d) to damage caused by accident, abuse, misuse, flood, fire, earthquake or other external causes; (e) to damage caused by operating the product outside the permitted or intended uses described by LaCie; (f) to damage caused by service (including upgrades and expansions) performed by anyone who is not a representative of LaCie or a LaCie Authorized Service Provider; (g) to a product or part that has been modified to alter functionality or capability without the written permission of LaCie; or (h) if any LaCie serial number on the product has been removed or defaced.

No LaCie dealer, agent, or employee is authorized to make any modification, extension, or addition to this warranty.

Any loss, corruption or destruction of data while using a LaCie drive is the sole responsibility of the user, and under no circumstances will LaCie be held liable for the recovery or restoration of this data. To help prevent the loss of your data, LaCie highly recommends that you keep TWO copies of your data; one copy on your external hard disk, for instance, and a second copy either on your internal hard disk, another external hard disk or some other form of removable storage media. LaCie offers a complete line of CD and DVD drives. If you would like more information on backup, please refer to our website.

LACIE IS NOT RESPONSIBLE FOR SPECIAL, INCIDENTAL, OR CONSEQUENTIAL DAMAGES RESULTING FROM ANY BREACH OF WARRANTY, OR UNDER ANY LEGAL THEORY, INCLUDING LOST PROFITS, DOWNTIME, GOODWILL, DAMAGE TO OR REPLACEMENT OF EQUIPMENT AND PROPERTY, AND ANY COSTS OF RECOVERING, REPROGRAMMING, OR REPRODUCING ANY PROGRAM OR DATA STORED IN OR USED WITH LACIE PRODUCTS EVEN IF IT HAS BEEN ADVISED OF THE POSSIBILITY OF SUCH DAMAGES.

Some states do not allow the exclusion or limitation of implied warranties or liability for incidental or consequential damages, so the above limitation or exclusion may not apply to you. This warranty gives you specific legal rights, and you may have other rights, which vary from state to state.

Your opening of your package, your use of the product, or your return of the enclosed Registration Card acknowledges that you have read and agree to the terms of this Agreement. You further agree that it is the complete and exclusive state of the agreement between us and supersedes any proposal or prior agreement, oral or written, and any other communications between us relating to the subject matter of this Agreement.

Read carefully all information related to warranty and precautions of use of your new LaCie product in the user manual.

For products purchased in the United States, you may contact LaCie at 7555 Tech Center Drive, Tigard, Oregon 97223 USA. Email: [sales@lacie.com](mailto:sales@lacie.com). Website: [www.lacie.com](http://www.lacie.com). Customer service: 503-844-4503.

## Service DOA

On rare occasions, a newly purchased LaCie product may be delivered in non-working order. We are working to avoid these issues, but unfortunately, these situations may arise from time to time. Within the 15 calendar days of purchase, should you experience an issue with your new LaCie product, we ask you to return the product to the place where it was originally bought. You will be required to give a proof of purchase.

## Customer Warning

Please be sure to back up your data before returning your drive to LaCie for repair. LaCie cannot under any circumstances guarantee the integrity of data remaining on a returned drive. We make no provisions for data recovery and cannot be held liable for any data loss on drives or media returned to LaCie.

All products returned to LaCie must be securely packaged in their original box and shipped with postage prepaid, except for Products registered under the Advance Care Option.

## NOTE TO AUSTRALIAN CUSTOMERS

Our goods come with guarantees that cannot be excluded under the Australian Consumer Law. You are entitled to a replacement or refund for a major failure and for compensation for any other reasonably foreseeable loss or damage. You are also entitled to have the goods repaired or replaced if the goods fail to be of acceptable quality and the failure does not amount to a major failure.

Contact us:

LaCie Australia, 6/151 Beauchamp Rd, Matraville NSW 2036 AUSTRALIA

Phone: 02 8063 3711

Email: [info.au@lacie.com](mailto:info.au@lacie.com)

For fast technical support, create a support ticket after registering your product at [www.lacie.com/au/register](http://www.lacie.com/au/register).